

A Genealogy Report For

DAVIS BRYANT "DAVE" WOODALL JR.

Created on 14 March 2023
"The Complete Genealogy Reporter"
© 2006-2015 Nigel Bufton Software
under license to MyHeritage.com Family Tree Builder



CONTENTS

1. PATERNAL ANCESTRY
2. MATERNAL ANCESTRY
3. DESCENDANTS
4. DIRECT RELATIONS
5. INDIRECTLY RELATED via KAREN DENISE WOODALL [MOORE]
6. INDIRECTLY RELATED via SHARON MOORE [MITCHELL]
7. INDIRECTLY RELATED via AMBER WILSON [POWELL]
8. INDIRECTLY RELATED via BILL ULYSSES DAVIS
9. INDIRECTLY RELATED via BILLIE JEAN DUPREE [STEPHENSON]
10. INDIRECTLY RELATED via RACHAEL JANE DUPREE [HONEYCUTT]
11. INDIRECTLY RELATED via SHOTZI BUTTS [BUIE]
12. INDIRECTLY RELATED via JANET LYNNE FRANKS [SWIGER]
13. INDIRECTLY RELATED via ELIZABETH BRETT [LOWE]
14. FAMILY TREES
15. NOTES
16. INDEX OF PLACES
17. INDEX OF DATES
18. INDEX OF INDIVIDUALS

1. PATERNAL ANCESTRY

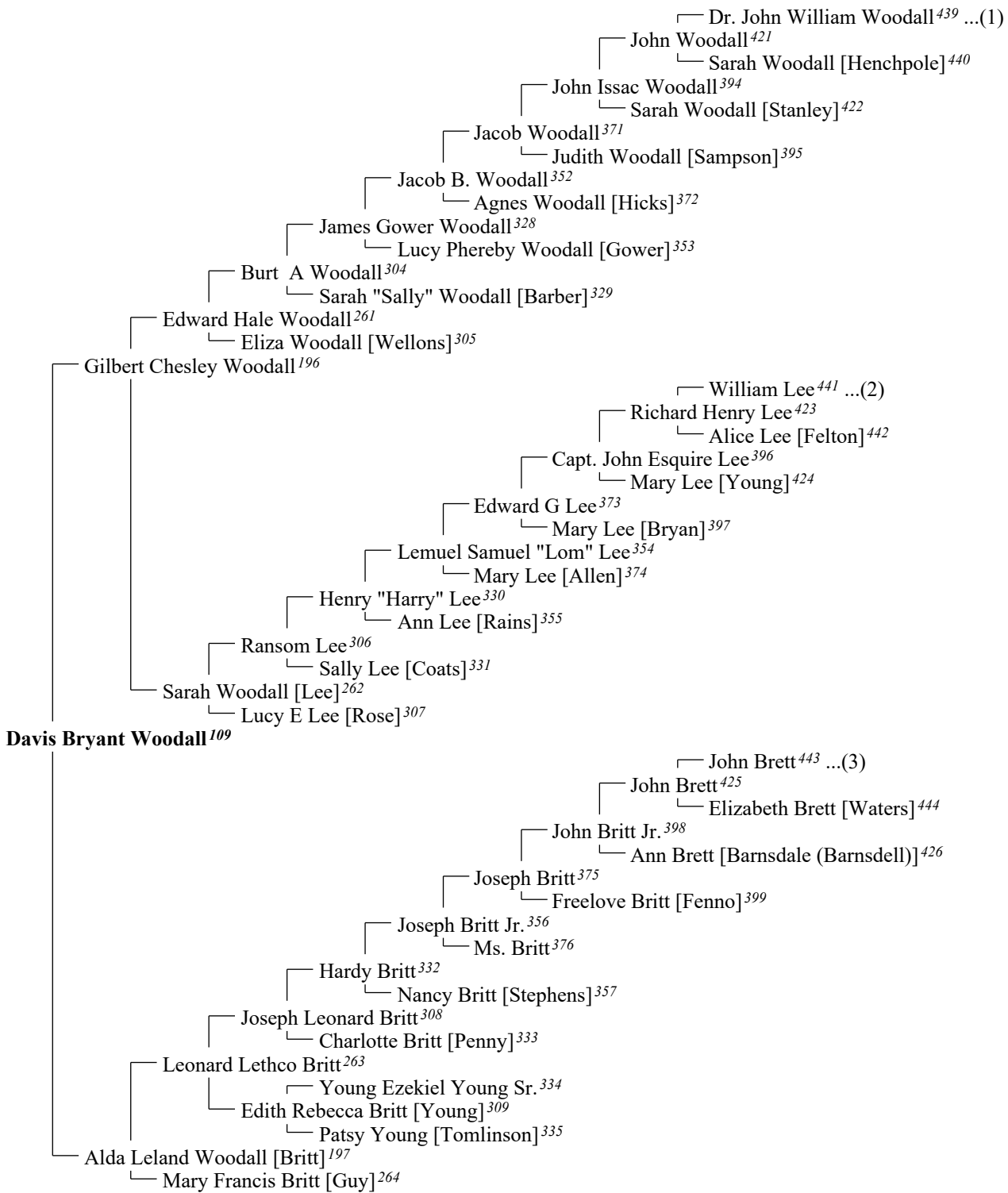

┌ Sir John Clois Clowes Clewlowe Clulow⁴⁹⁰
 └ Laurence Woodall⁴⁸⁰
 ┌ Lady Isabell Clois Clowes Clewlowe Clulow⁴⁹¹
 └ Richard Woodall⁴⁷⁰
 ┌ Agnes Woodall [Inu/Light] Light]⁴⁸¹
 └ Surgeon General John Woodall⁴⁵⁷
 ┌ Mary Woodall [Ithell]⁴⁷¹
 └ (1)...Dr. John William Woodall⁴³⁹
 └ Sara Woodall [Staelie]⁴⁵⁸

┌ Sir Fulk Marcher Lord of Whittington and Alveston FitzWarin III⁵⁵² ...(4)
 └ Hugo "Hugo de La Lea /de Lee/" de Lega "⁵⁴⁸
 ┌ Eva FitzWarin [de Blancminister Warrine]⁵⁵³
 └ Reginald "Reginald Reynor de la Lea" de Laga⁵⁴⁴
 ┌ Christian De Stainton de Lega⁵⁴⁹
 └ Sir John "John Lee Esquire" de la Lee⁵⁴⁰
 ┌ Rei Lega de Laga⁵⁴⁵
 └ Sir Thomas de la Lee⁵³⁶
 ┌ Rei Mnu de la Lee⁵⁴¹
 └ John de la Lee II⁵³²
 ┌ Petronilla de la Lee [Corbet]⁵³⁷
 └ Roger "Robert" de Lee⁵²⁸
 ┌ Margaret de la Lee⁵³³
 └ Robert "Robert /De Lee/" Lee "⁵²⁴
 ┌ Margaret "Margaret de Astley" de Lee [Astley]⁵²⁹
 └ Radolphus "Ralph de Lee" Lee⁵¹⁹
 ┌ Petronella "Petronilla Of Lampley /De Lee/" Lee [Pimhall] "⁵²⁵
 └ Sir Richard "Recardus /De Lee/Lee" Lee Lee"⁵¹⁴
 ┌ Isabella Lee [Ridley]⁵²⁰
 └ Sir Thomas Lee⁵⁰⁸
 ┌ Margery Sprencheaux Lee [Sprencheaux]⁵¹⁵
 └ Sir Humphrey "Humphrey De Lee" Lee⁵⁰⁰
 ┌ Johanna Lee [Morton]⁵⁰⁹
 └ Sir John "John Lee Esquire" Lee⁴⁹²
 ┌ Katherine Lee [Blount]⁵⁰¹
 └ Richard Lee⁴⁸²
 ┌ Joyce Lee [Romney]⁴⁹³
 └ John Lee Sr.⁴⁷²
 ┌ Elizabeth Lee [Bendey]⁴⁸³
 └ Colonel Richard Henry Lee⁴⁵⁹
 ┌ Jane Lee [Hancock]⁴⁷³
 └ (2)...William Lee⁴⁴¹
 ┌ Ann Lee [Constable]⁴⁶⁰

┌ Nicolas Brett⁵¹⁶
 └ Thomas Brett⁵¹⁰
 ┌ Randolphe Brett⁵⁰²
 └ Mrs Brett [Baginholde]⁵¹¹
 ┌ Edward Brett⁴⁹⁴
 └ Ann Brett [Woode]⁵⁰³
 ┌ Randle Brett Britt⁴⁸⁴
 └ Cissely Brett [Fitton]⁴⁹⁵
 ┌ Thomas Brett Britt⁴⁷⁴
 └ Margaret Britt [Chetwynd]⁴⁸⁵
 ┌ Edmund Brett⁴⁶¹
 └ Ursula Britt [Coward]⁴⁷⁵
 (3)...John Brett⁴⁴³
 └ Elizabeth Susan Brett [Gosling]⁴⁶²

┌ Warine "The Sherriff" de Metz⁵⁶⁸
 └ Sir Guy Warin "the Bold" de Metz⁵⁶⁴
 ┌ Roger I de Montgomery⁵⁸⁷
 └ Roger II de Montgomery⁵⁸⁵
 ┌ Roger III de Montgomery⁵⁸³
 └ William de Montgomery⁵⁸⁰
 ┌ Hugh I de Montgomery⁵⁷⁶
 └ Elizabeth de Montgomery [de Tripon]⁵⁸¹
 ┌ Gilbert de Montgomery⁵⁷²
 └ Joscelina de Montgomery [de Normandie]⁵⁷⁷
 ┌ Aimeria Emma de Montgomery de Metz [de Montgomery]⁵⁶⁹
 └ Joseline de Montgomery [de Vetulis]⁵⁷³
 ┌ Fulk "Fulko" FitzWarin I, Lord of Whittington and Alderbury, "Guarine de Meer"⁵⁶⁰
 └ Baroness Melette Maud ,Heiress of Whittington, "Maud de Ingelrica" de Metz [Peverell]⁵⁶⁵
 ┌ Fulk II "Brunin" Lord of Whittington and Alveston FitzWarin II⁵⁵⁶
 └ Miletta de Whittington FitzWarin [de Whittington]⁵⁶¹
 (4)...Sir Fulk Marcher Lord of Whittington and Alveston FitzWarin III⁵⁵²
 └ Hawise FitzWarin [de Dinan]⁵⁵⁷

2. MATERNAL ANCESTRY

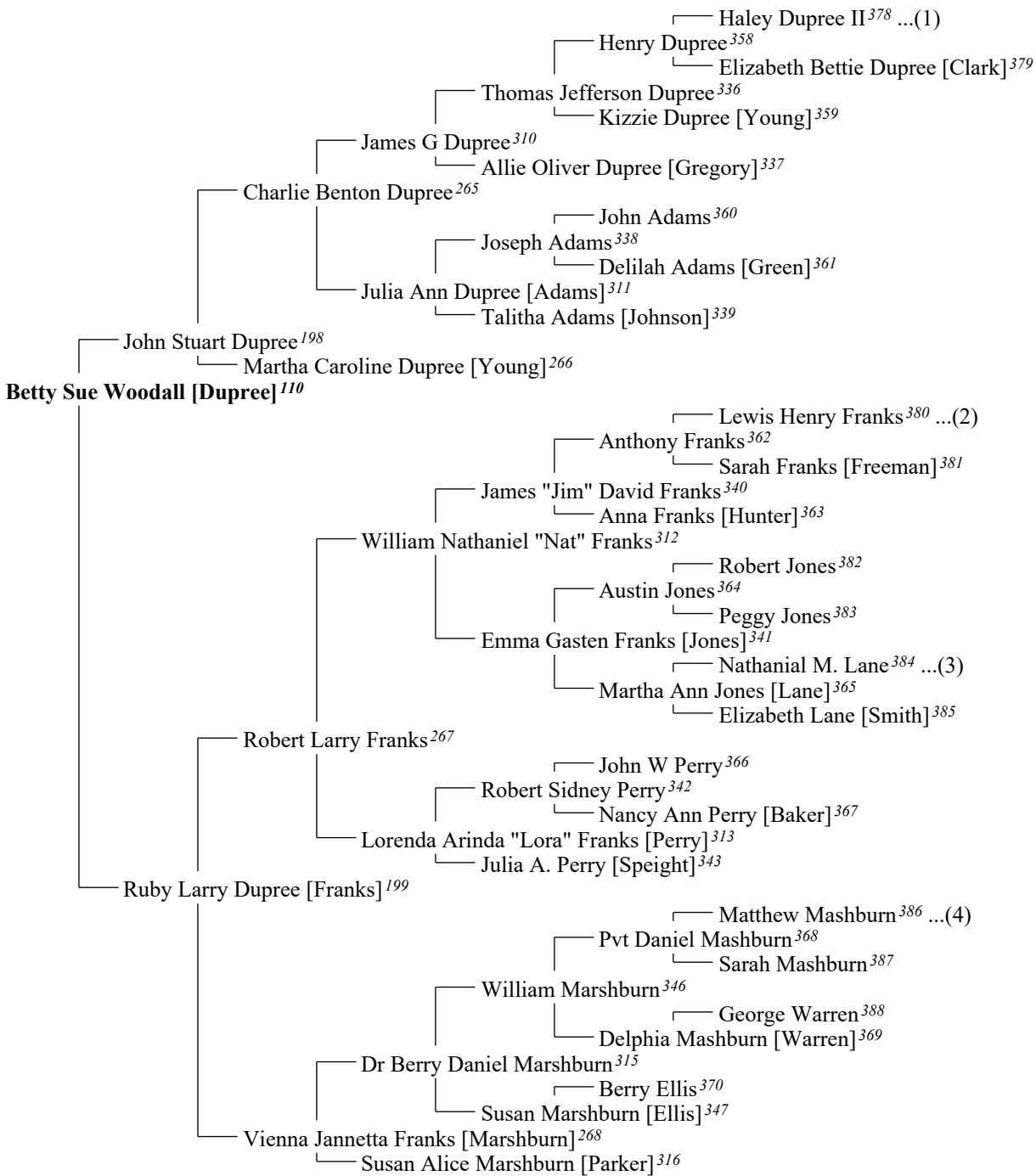

- ┌ Adminius Amminius de podio del puech⁵⁸⁴ ... (5)
- ┌ Norman Anglo saxony (de Pugio) de podio del puech⁵⁸²
- ┌ Amelius Simplicius (de Pugio) de podio del puech⁵⁷⁸
- ┌ Guillaume de podio del puech⁵⁷⁴
- ┌ Jeanne de podio del puech [d'Archingaux]⁵⁷⁹
- ┌ Raymond Guillaume de podio⁵⁷⁰
- ┌ Berchta de podio del puech [d'Opfikon]⁵⁷⁵
- ┌ Grand Chamberlain Conrad II Raphael (del Poggio) Du Puy⁵⁶⁶
- ┌ Amelie de podio [de Heitz]⁵⁷¹
- ┌ Hugues Lord of Rochefort Du Puy I⁵⁶²
- ┌ Pétronille de Archaic] Du Puy, Countess of Conteville [de Béréngs⁵⁶⁷
- ┌ Chevalier Alleman Du Puy I⁵⁵⁸
- ┌ Deurard DE POISIEU Du Puy⁵⁶³
- ┌ Chevalier Hugues Apifer & Montbrun Du Puy II , Seigneur de Pereins, Rochefort⁵⁵⁴
- ┌ Lady Veronique Ademar Du Puy⁵³⁹
- ┌ Chevalier Alleman de Montbrun Seigneur de Pereins Du Puy II⁵⁵⁰
- ┌ Floride Du Puy [De Morian]⁵⁵⁵
- ┌ Alleman Sgr. of Bordeau Du Puy III⁵⁴⁶
- ┌ Alix Princess of Dauphine Du Puy⁵⁵¹
- ┌ Chevalier Alleman Du Puy IV⁵⁴²
- ┌ Beatrix Tournon Du Puy [Artod]⁵⁴⁷
- ┌ Lord Alleman Du Puy V⁵³⁸
- ┌ Eleanore Alleman Du Puy [de Lancoil]⁵⁴³
- ┌ Gilles Lord of Rochefort Du Puy I, Knight⁵³⁴
- ┌ Ainarde Du Puy [De Roland]⁵³⁹
- ┌ Gillies Lord of Pereins Du Puy II⁵³⁰
- ┌ Alix Du Puy [de Bellecombe]⁵³⁵
- ┌ Sir Richard DuPre⁵²⁶
- ┌ Lady Marie Florence Du Puy [de Hauteville]⁵³¹
- ┌ Sir Josias DuPre⁵²¹
- ┌ Paschale DuPre [DeVermondois]⁵²⁷
- ┌ Jaques Henre DuPre II⁵¹⁷
- ┌ Lady Maria DuPre [Esteves]⁵²²
- ┌ Jaques "James" Henre DuPre⁵¹²
- ┌ Agnes DuPre [Villiers]⁵¹⁸
- ┌ Louis Claude DuPre I⁵⁰⁴
- ┌ Anonette DuPre [Gaillard]⁵¹³
- ┌ Louis Claude DuPre II⁴⁹⁶
- ┌ Alice DuPre [Jospin]⁵⁰⁵
- ┌ Louis DuPre⁴⁸⁶
- ┌ Suzanne DuPre [Moeze]⁴⁹⁷
- ┌ Jean DuPre⁴⁷⁶
- ┌ Elizabeth DuPre [Gonzales]⁴⁸⁷
- ┌ Barthelemy DuPre⁴⁶⁴
- ┌ Margeurite DuPre [Bessonnet]⁴⁷⁷
- ┌ Josias "Joseph" Crancie Dupree⁴⁴⁷
- ┌ Matilda DuPree [Robin]⁴⁶⁵
- ┌ Loys "Louis" Dupree⁴²⁷
- ┌ Mynetta "Mary" Denizot Dupree [Lamoreaux]⁴⁴⁸
- ┌ Haley Dupree⁴⁰²
- ┌ Larance Lara Dupree [Ellerbee]⁴²⁸
- (1)...Haley Dupree II³⁷⁸
- ┌ Susannah Elizabeth Dupree [Garris]⁴⁰³

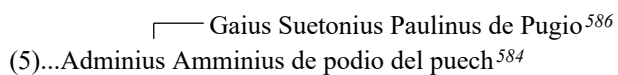
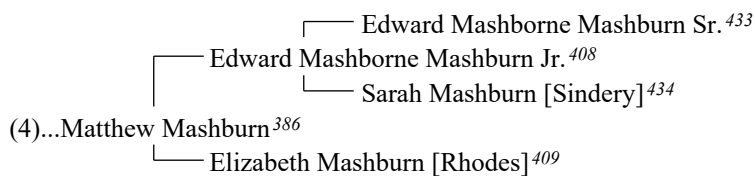
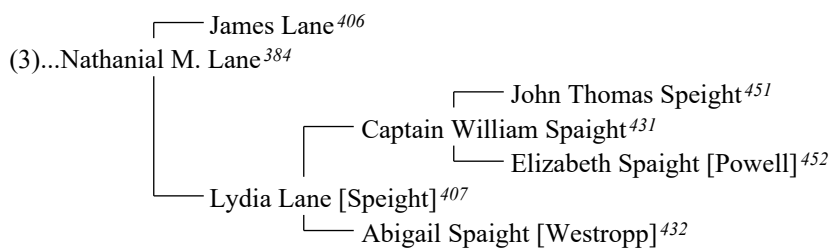
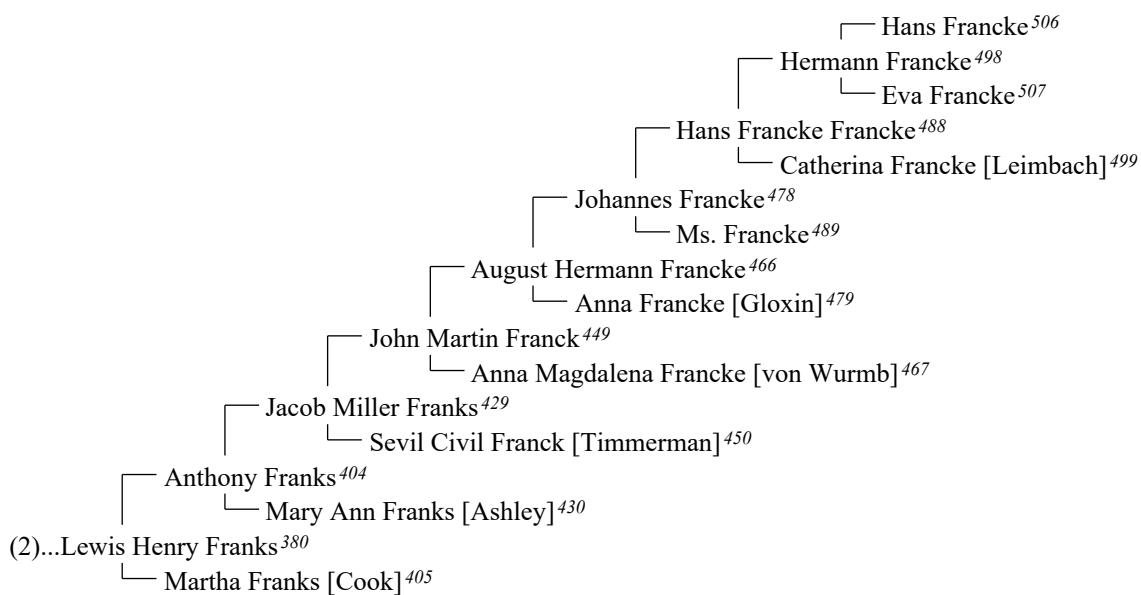

3. DESCENDANTS

Davis Bryant "Dave" Woodall Jr.⁵¹
+Karen Denise Woodall [Moore]⁵²

- Bryant Lee Woodall¹⁷
 - +Jesse Marie Woodall [Morgan]¹⁸
 - Walker Samuel Woodall¹
 - Wyatt Lee Woodall²
- Cody Davis Woodall¹⁹
 - +Christine Denise Woodall [Wilder]²⁰
 - Peyton James Woodall³
 - Carter Davis Woodall⁴
- Chase Hunter Woodall²¹

4. DIRECT RELATIONS

Generation of Grandchildren

1. WALKER SAMUEL WOODALL (Davis' grandson) was born on 16 February 2021, in UNC Health Johnson, Clayton, NC, to Bryant Lee Woodall¹⁷ and Jesse Marie Woodall [Morgan]¹⁸, as shown in family tree 1.
2. WYATT LEE WOODALL (Davis' grandson) was born on 16 February 2021, in UNC Health Johnson, Clayton, NC, to Bryant Lee Woodall¹⁷ and Jesse Marie Woodall [Morgan]¹⁸, as shown in family tree 1.
3. PEYTON JAMES WOODALL (Davis' grandson) was born on 14 November 2020, in UNC Rex Hospital, Raleigh, North Carolina, to Cody Davis Woodall¹⁹ and Christine Denise Woodall [Wilder]²⁰, as shown in family tree 2.
4. CARTER DAVIS WOODALL (Davis' grandson) was born on 11 December 2021, in UNC Rex Hospital, Raleigh, North Carolina, to Cody Davis Woodall¹⁹ and Christine Denise Woodall [Wilder]²⁰, as shown in family tree 2.
5. TOVI PIPER CAPPS (Davis' great-niece) was born on 23 September 2009, in Wake Medical Center, Cary, North Carolina, to Joseph Edgar Capps Jr.²² and Kristen Capps [Kidwell]²³.
6. MADDOX CAPPS (Davis' great-nephew) was born to Joseph Edgar Capps Jr.²² and Kristen Capps [Kidwell]²³.
7. CAMDEN SMITH (Davis' great-nephew) was born to Harry Lee Smith Jr.²⁵ and Jennifer Lynn Smith [Capps]²⁴.
8. CALEB SMITH (Davis' great-nephew) was born on 15 July 1999 to Harry Lee Smith Jr.²⁵ and Jennifer Lynn Smith [Capps]²⁴.
9. CAITLIN SMITH (Davis' great-niece) was born to Harry Lee Smith Jr.²⁵ and Jennifer Lynn Smith [Capps]²⁴.
10. ADDISON BAILEY CAPPS (Davis' great-niece) was born on 30 September 2005 to Adam Bryant Capps²⁶ and Jessica Capps [Wood]²⁷.
11. AUDREY PANKOP (Davis' cousin, twice removed) was born to Ashley Pankop³¹ and Sarah Pankop [Chambers]³⁰.
12. PALMER GRACE HONEYCUTT (Davis' cousin, twice removed) was born on 7 December 2020 to Cade Wallace Honeycutt³⁸ and Hannah Elizabeth Honeycutt [Overby]³⁹.
13. KENDALL THOMAS (Davis' second cousin, twice removed) was born to Chad David Thomas⁴⁶ and Susan "Kelly" Thomas [Young]⁴⁵.
14. TAYLOR THOMAS (Davis' second cousin, twice removed) was born to Chad David Thomas⁴⁶ and Susan "Kelly" Thomas [Young]⁴⁵.
15. REAGAN STEPHENSON (Davis' second cousin, twice removed) was born to Tracy Alan Stephenson⁴⁸ and Allison Leslie Stephenson [Young]⁴⁷.
16. ADDISON STEPHENSON (Davis' second cousin, twice removed) was born to Tracy Alan Stephenson⁴⁸ and Allison Leslie Stephenson [Young]⁴⁷.

Generation of Children

17. BRYANT LEE WOODALL (Davis' son) was born on 4 May 1990, in Wake Medical Center, Raleigh, North Carolina, to Davis Bryant "Dave" Woodall Jr.⁵¹ and Karen Denise Woodall [Moore]⁵², as shown in family tree 3.
18. JESSE MARIE WOODALL [MORGAN] (Davis' daughter-in-law) was born on 29 October 1994.
Bryant Lee Woodall¹⁷, aged 29, married Jesse Marie Woodall [Morgan], aged 24, on 12 October 2019 in Gregory Vineyards, Angier, NC. They had two sons:
Walker Samuel Woodall¹ in 2021
Wyatt Lee Woodall² in 2021
This family is shown as family tree 1.
19. CODY DAVIS WOODALL (Davis' son) was born on 6 August 1992, in Wake Medical Center, Raleigh, North Carolina, to Davis Bryant "Dave" Woodall Jr.⁵¹ and Karen Denise Woodall [Moore]⁵², as shown in family tree 3.

Note: 22 1/2 inches, 9 lbs 4 ozs.

(Birth)

20. CHRISTINE DENISE WOODALL [WILDER] (Davis' daughter-in-law) was born on 17 July 1994.
Cody Davis Woodall¹⁹, aged 23, married Christine Denise Woodall [Wilder], aged 21, on 15 May 2016 in Market Hall Raleigh, North Carolina. They had two sons:
Peyton James Woodall³ in 2020
Carter Davis Woodall⁴ in 2021
This family is shown as family tree 2.
21. CHASE HUNTER WOODALL (Davis' son) was born on 11 February 1997, in Raleigh Community (now Duke), Raleigh, North Carolina, to Davis Bryant "Dave" Woodall Jr.⁵¹ and Karen Denise Woodall [Moore]⁵², as shown in family tree 3.
22. JOSEPH EDGAR CAPPS JR. (Davis' nephew) was born on 14 November 1979 to Joseph Edgar Capps⁵⁴ and Linda Kay Capps [Woodall]⁵³.
23. KRISTEN CAPPS [KIDWELL] (Davis' nephew's wife) was born on 25 March 1980.
Joseph Edgar Capps Jr.²² married Kristen Capps [Kidwell]. They had two children:
Tovi Piper Capps⁵ in 2009
Maddox Capps⁶
Note: 8:42 pm
7 lbs 14 oz 20 in.
24. JENNIFER LYNN SMITH [CAPPS] (Davis' niece) was born on 21 December 1981 to Joseph Edgar Capps⁵⁴ and Linda Kay Capps [Woodall]⁵³.
25. HARRY LEE SMITH JR. (Davis' niece's husband) was born on 31 March 1978.
Harry Lee Smith Jr., aged 35, married Jennifer Lynn Smith [Capps]²⁴, aged 31, on 21 June 2013 in Edenton Street United Methodist Church Raleigh, North Carolina. They had three children:
Camden Smith⁷
Caleb Smith⁸ in 1999
Caitlin Smith⁹
26. ADAM BRYANT CAPPS (Davis' nephew) was born on 24 November 1985 to Joseph Edgar Capps⁵⁴ and Linda Kay Capps [Woodall]⁵³.
27. JESSICA CAPPS [WOOD] (Davis' nephew's wife) was born on 3 July 1986.
Adam Bryant Capps²⁶ married Jessica Capps [Wood]. They had one daughter:
Addison Bailey Capps¹⁰ in 2005
28. MICHELLE BUTTS (Davis' cousin, once removed) was born to James Lenn Butts⁵⁵ and Shotzi Butts [Buie]⁵⁶.
29. KRISTY CHAMBERS (Davis' cousin, once removed) was born to Johnnie Loteze Chambers⁵⁸ and Leland Diane Chambers [Butts]⁵⁷.
30. SARAH PANKOP [CHAMBERS] (Davis' cousin, once removed) was born to Johnnie Loteze Chambers⁵⁸ and Leland Diane Chambers [Butts]⁵⁷.
31. ASHLEY PANKOP (Davis' cousin's husband, once removed).
Ashley Pankop married Sarah Pankop [Chambers]³⁰. They had one daughter:
Audrey Pankop¹¹
32. REV. BRIAN DAVIS (Davis' cousin, once removed) was born to Robert Britt Davis⁵⁹ and Carolyn Davis⁶⁰.
33. CHRISTOPHER CULLEN DAVIS (Davis' cousin, once removed) was born to Robert Britt Davis⁵⁹ and Carolyn Davis⁶⁰.
34. WILL DAVIS (Davis' cousin, once removed) was born to Robert Britt Davis⁵⁹ and Carolyn Davis⁶⁰.
35. SHAUN BRADSHAW (Davis' cousin, once removed) was born to Ronald Williard "Buddy" Davis⁶¹.
36. TOMMY THOMPSON (Davis' cousin, once removed) was born to Tommy Thompkins⁶⁴ and Rebecca Sue "Becky" Eason [Dupree]⁶³.
37. BLISS THOMPSON (Davis' cousin, once removed) was born to Tommy Thompkins⁶⁴ and Rebecca Sue "Becky" Eason [Dupree]⁶³.

38. CADE WALLACE HONEYCUTT (Davis' cousin, once removed) was born on 12 May 1997 to Michael Wallace Honeycutt⁶⁶ and Laura Lynn Honeycutt [Dupree]⁶⁵.
39. HANNAH ELIZABETH HONEYCUTT [OVERBY] (Davis' cousin's wife, once removed) was born in 1997.
Cade Wallace Honeycutt³⁸, aged 25, married Hannah Elizabeth Honeycutt [Overby], aged about 25, on 28 October 2022 in Mount Pleasant, South Carolina. They had one daughter:
Palmer Grace Honeycutt¹² in 2020
40. ALLY ELIZABETH HONEYCUTT (Davis' cousin, once removed) was born to Michael Wallace Honeycutt⁶⁶ and Laura Lynn Honeycutt [Dupree]⁶⁵.
41. JOHN KEITH JACKSON II (Davis' second cousin, once removed) was born to Keith Jackson⁷² and Robin Jackson [Bradley]⁷¹.
42. BRADLEY RAY JACKSON (Davis' second cousin, once removed) was born to Keith Jackson⁷² and Robin Jackson [Bradley]⁷¹.
43. MARKIE ELISABETH BEAVER (Davis' second cousin, once removed) was born to Mark Beaver⁷⁴ and Kerry Lyn Beaver [Bradley]⁷³.
44. BRANDON LEE PRICE (Davis' second cousin, once removed) was born on 13 January 1984 to Mark Lee Price⁸⁹ and Susan "Elaine" Price [Dupree]⁸⁷. He died on 30 October 2010, aged 26. He was buried in Lakeside Memorial Gardens, Harnett County, North Carolina.
45. SUSAN "KELLY" THOMAS [YOUNG] (Davis' second cousin, once removed) was born in 1970 to Bobby Willis Young⁹⁰ and Susan "Elaine" Price [Dupree]⁸⁷. Susan became known as "Kelly".
46. CHAD DAVID THOMAS (Davis' second cousin's husband, once removed) was born in 1969.
Chad David Thomas, aged about 23, married Susan "Kelly" Thomas [Young]⁴⁵, aged about 22, on 22 August 1992. They had two daughters:
Kendall Thomas¹³
Taylor Thomas¹⁴
47. ALLISON LESLIE STEPHENSON [YOUNG] (Davis' second cousin, once removed) was born in 1974 to Bobby Willis Young⁹⁰ and Susan "Elaine" Price [Dupree]⁸⁷.
48. TRACY ALAN STEPHENSON (Davis' second cousin's husband, once removed) was born in 1975.
Tracy Alan Stephenson, aged about 22, married Allison Leslie Stephenson [Young]⁴⁷, aged about 23, on 16 May 1998. They had two daughters:
Reagan Stephenson¹⁵
Addison Stephenson¹⁶
49. JEREMY WAYNE CARROLL (Davis' third cousin, once removed) was born to Frankie Wayne "Red Bug" Carroll¹⁰⁰ and Jenny Carroll [Nobling]¹⁰¹.
50. JAMIE BARWICK [CARROLL] (Davis' third cousin, once removed) was born to Frankie Wayne "Red Bug" Carroll¹⁰⁰ and Jenny Carroll [Nobling]¹⁰¹.

Generation of Peers

51. DAVIS BRYANT "DAVE" WOODALL JR. (The subject of this report) was born on 12 July 1953, in Rex Hospital, Raleigh, North Carolina, to Davis Bryant Woodall¹⁰⁹ and Betty Sue Woodall [Dupree]¹¹⁰, as shown in family tree 4. Davis became known as "Dave". Davis became a Telecommunication Systems Analyst, State Government, NC.
The following information is also recorded for Davis. Email: uncrus@gmail.com.
52. KAREN DENISE WOODALL [MOORE] (Davis' wife) was born on 10 June 1963, in Rex Hospital, Raleigh, North Carolina, to Roy Neal Moore Jr.⁶¹⁵ and Betty Jean "BJ" Moore [Wilson]⁶¹⁶. Karen became a Purchasing Compliance Officer.
[See also: *Indirectly Related via Karen Denise Woodall [Moore]*
Davis Bryant "Dave" Woodall Jr.⁵¹, aged 34, married Karen Denise Woodall [Moore], aged 24, on 12 December 1987 in Ernest Myatt Presbyterian Church, Raleigh, North Carolina. They had three sons:
Bryant Lee Woodall¹⁷ in 1990
Cody Davis Woodall¹⁹ in 1992
Chase Hunter Woodall²¹ in 1997
This family is shown as family tree 3.

53. LINDA KAY CAPPS [WOODALL] (Davis' sister) was born on 3 December 1954 to Davis Bryant Woodall¹⁰⁹ and Betty Sue Woodall [Dupree]¹¹⁰, as shown in family tree 4. Linda became a Mom and accountant.
54. JOSEPH EDGAR CAPPS (Davis' brother-in-law) was born on 30 July 1951. Joseph became a Building Contractor.
Joseph Edgar Capps, aged 22, married Linda Kay Capps [Woodall]⁵³, aged 19, on 29 June 1974. They had three children:
Joseph Edgar Capps Jr.²² in 1979
Jennifer Lynn Smith [Capps]²⁴ in 1981
Adam Bryant Capps²⁶ in 1985
55. JAMES LENN BUTTS (Davis' cousin) was born on 9 February 1945 to James Clayborn Butts¹¹² and Doris Britt Butts [Woodall]¹¹¹.
56. SHOTZI BUTTS [BUIE] (Davis' cousin's wife).
Shotzi married twice. She was married to James Lenn Butts⁵⁵ and Mr. Buie⁶⁷¹.
[See also: *Indirectly Related via Shotzi Butts [Buie]*]
James Lenn Butts⁵⁵ married Shotzi Butts [Buie], and they were divorced. They had one daughter:
Michelle Butts²⁸
57. LELAND DIANE CHAMBERS [BUTTS] (Davis' cousin) was born on 2 March 1948 to James Clayborn Butts¹¹² and Doris Britt Butts [Woodall]¹¹¹.
58. JOHNNIE LOTEZE CHAMBERS (Davis' cousin's husband) was born in 1946. He died on 22 June 2008, aged about 61.
Johnnie Loteze Chambers, aged about 25, married Leland Diane Chambers [Butts]⁵⁷, aged 23, on 19 August 1971. They had two daughters:
Kristy Chambers²⁹
Sarah Pankop [Chambers]³⁰
The following information is also recorded for this family. Widowed.
59. ROBERT BRITT DAVIS (Davis' cousin) was born on 17 December 1946 to Bill Ulysses Davis¹¹⁴ and Frances Loraine Davis [Woodall]¹¹³.
60. CAROLYN DAVIS (Davis' cousin's wife).
Robert Britt Davis⁵⁹ married Carolyn Davis. They had three sons:
Rev. Brian Davis³²
Christopher Cullen Davis³³
Will Davis³⁴
61. RONALD WILLIARD "BUDDY" DAVIS (Davis' cousin) was born on 22 January 1948 to Bill Ulysses Davis¹¹⁴ and Frances Loraine Davis [Woodall]¹¹³. Ronald became known as "Buddy". He died (Cancer) on 28 June 2003, aged 55.
Ronald fathered one son:
Shaun Bradshaw³⁵
62. LARRY GENE DUPREE (Davis' cousin) was born on 21 July 1961 to Charles Larry Dupree¹¹⁵ and Billie Jean Dupree [Stephenson]¹¹⁶. He died (Gun shot wound to the leg by Becky husband - bleed to death) on 16 March 1982, aged 20. He was buried in Harnett Memorial Park, Lillington, North Carolina.
63. REBECCA SUE "BECKY" EASON [DUPREE] (Davis' cousin) was born on 20 May 1963 to Charles Larry Dupree¹¹⁵ and Billie Jean Dupree [Stephenson]¹¹⁶. Rebecca became known as "Becky".
64. TOMMY THOMPSON (Davis' cousin's husband).
Tommy Thompkins married Rebecca Sue "Becky" Eason [Dupree]⁶³, and they were divorced. They had two children:
Tommy Thompkins³⁶
Bliss Thompkins³⁷
65. LAURA LYNN HONEYCUTT [DUPREE] (Davis' cousin) was born on 4 October 1967 to James Lynwood Dupree¹¹⁸ and Larue Dupree [Williford]¹¹⁹.
66. MICHAEL WALLACE HONEYCUTT (Davis' cousin's husband).
Michael Wallace Honeycutt married Laura Lynn Honeycutt [Dupree]⁶⁵, aged 28, on 9 December 1995. They had two children:
Cade Wallace Honeycutt³⁸ in 1997
Ally Elizabeth Honeycutt⁴⁰
67. CHRISTOPHER LEE WOODALL (Davis' second cousin) was born to Harold Bert Woodall¹³⁰ and Shelby Woodall [Weaver]¹³¹.

68. TAMARA WOODALL (Davis' second cousin's wife).
Christopher Lee Woodall⁶⁷ married Tamara Woodall.
69. MICHAEL SCOTT WOODALL (Davis' second cousin) was born to Harold Bert Woodall¹³⁰ and Shelby Woodall [Weaver]¹³¹.
70. KIMBERLY WOODALL (Davis' second cousin's wife).
Michael Scott Woodall⁶⁹ married Kimberly Woodall.
71. ROBIN JACKSON [BRADLEY] (Davis' second cousin) was born in 1969 to Rex Kenneth Bradley Jr.¹³³ and Evelyn Bradley [Pleasant]¹³⁴.
72. KEITH JACKSON (Davis' second cousin's husband).
Keith Jackson married Robin Jackson [Bradley]⁷¹. They had two sons:
John Keith Jackson II⁴¹
Bradley Ray Jackson⁴²
73. KERRY LYN BEAVER [BRADLEY] (Davis' second cousin) was born in 1973 to Rex Kenneth Bradley Jr.¹³³ and Evelyn Bradley [Pleasant]¹³⁴.
74. MARK BEAVER (Davis' second cousin's husband).
Mark Beaver married Kerry Lyn Beaver [Bradley]⁷³. They had one daughter:
Markie Elisabeth Beaver⁴³
75. CLARE MELISSA BRADLEY (Davis' second cousin) was born in 1980 to Jerry Mac Bradley¹³⁵ and Jane Bradley [S]¹³⁶.
76. REX BRADLEY (Davis' second cousin) was born in 1981 to Jerry Mac Bradley¹³⁵ and Jane Bradley [S]¹³⁶.
77. LEEANN M BRADLEY (Davis' second cousin) was born in 1988 to Jerry Mac Bradley¹³⁵ and Jane Bradley [S]¹³⁶.
78. KATHY LYNN ROWE [DUPREE] (Davis' second cousin) was born on 14 September 1952 to Stacy Lee Dupree¹³⁷ and Doris Pearl Dupree [Wilkerson]¹³⁸.
79. LARRY DAVID ROWE (Davis' second cousin's husband) was born in 1947.
Larry David Rowe married Kathy Lynn Rowe [Dupree]⁷⁸.
80. GARY KEN DUPREE (Davis' second cousin) was born on 2 December 1955 to Stacy Lee Dupree¹³⁷ and Doris Pearl Dupree [Wilkerson]¹³⁸.
81. ELLIE LEIGH "BUNNY" DUPREE [WOOD] (Davis' second cousin's wife) was born on 15 January 1951. Ellie became known as "Bunny".
Gary Ken Dupree⁸⁰, aged 34, married Ellie Leigh "Bunny" Dupree [Wood], aged 39, on 18 August 1990.
82. LARRY GLENN DUPREE (Davis' second cousin) was born on 2 December 1955 to Stacy Lee Dupree¹³⁷ and Doris Pearl Dupree [Wilkerson]¹³⁸.
83. MELODY JEAN DUPREE [PAGE] (Davis' second cousin's wife) was born on 4 June 1962.
Larry Glenn Dupree⁸², aged 29, married Melody Jean Dupree [Page], aged 22, on 26 January 1985.
84. LISA ANN FUQUAY (Davis' second cousin) was born on 13 May 1960 to Cecil Adair Fuquay¹⁴⁰ and Shirley Ann Fuquay [Dupree]¹³⁹.
85. KEVIN RAY DUPREE (Davis' second cousin) was born on 26 July 1967 to Donnie Ray Dupree¹⁴¹ and Linda Carol Dupree [Glasgow]¹⁴³.
86. KARI DUPREE (Davis' second cousin's wife) was born on 13 October 1970.
Kevin Ray Dupree⁸⁵ married Kari Dupree.
87. SUSAN "ELAINE" PRICE [DUPREE] (Davis' second cousin) was born on 31 March 1951 to James "Wilburn" Dupree¹⁴⁶ and Etholea Dupree [Hardee]¹⁴⁷. Susan became known as "Elaine". She died (Cancer) on 14 February 2018, aged 66. She was buried in lakeside Memorial Gardens, Harnett County, North Carolina.
Susan married three times. She was married to Roger Wayne Maye⁸⁸, Mark Lee Price⁸⁹ and Bobby Willis Young⁹⁰.
88. ROGER WAYNE MAYE (Davis' second cousin's husband) was born in 1950.
Roger Wayne Maye, aged about 19, married Susan "Elaine" Price [Dupree]⁸⁷, aged 18, on 20 December 1969.
89. MARK LEE PRICE (Davis' second cousin's husband) was born on 13 April 1956.
Mark Lee Price, aged 26, married Susan "Elaine" Price [Dupree]⁸⁷, aged 31, on 29 January 1983. They had one son:
Brandon Lee Price⁴⁴ in 1984

90. BOBBY WILLIS YOUNG (Davis' second cousin's husband) was born on 28 August 1939. He died (Cancer) on 3 April 2010, aged 70.
 Bobby Willis Young married Susan "Elaine" Price [Dupree]⁸⁷. They had two daughters:
 Susan "Kelly" Thomas [Young]⁴⁵ in 1970
 Allison Leslie Stephenson [Young]⁴⁷ in 1974
91. DENNIS ALAN O'NEAL (Davis' second cousin) was born on 1 September 1959 to Herman Dennis O'Neal¹⁵⁰ and Patsy Ennis O'Neal [Dupree]¹⁴⁹.
92. TERRY LEE O'NEAL (Davis' second cousin) was born on 12 December 1960 to Herman Dennis O'Neal¹⁵⁰ and Patsy Ennis O'Neal [Dupree]¹⁴⁹.
93. MARK ANDREW O'NEAL (Davis' second cousin) was born in 1967 to Herman Dennis O'Neal¹⁵⁰ and Patsy Ennis O'Neal [Dupree]¹⁴⁹.
94. TAMMY RICHELLE FEREBEE [DUPREE] (Davis' second cousin) was born on 5 October 1962 to Thomas Layton Dupree¹⁵¹ and Mary Lynn Dupree [Smith]¹⁵².
95. BARRY SHERMAN DUPREE (Davis' second cousin) was born on 29 October 1964 to Thomas Layton Dupree¹⁵¹ and Mary Lynn Dupree [Smith]¹⁵². He died (Muscular Dystrophy) on 29 October 1964, as an infant. He was buried in Lakeside Memorial Gardens, Harnett County, North Carolina.
96. HEATHER DAWN MARLER [DUPREE] (Davis' second cousin) was born on 18 February 1975 to Thomas Layton Dupree¹⁵¹ and Mary Lynn Dupree [Smith]¹⁵².
97. JOSEPH RONALD "RONNIE" ADAMS (Davis' second cousin) was born on 9 January 1955 to Raythell Greene Adams¹⁵³ and Emily Adams [Blanchard]¹⁵⁴. Joseph became known as "Ronnie". He died (Lung Cancer) on 24 December 2016, aged 61. He was buried in Harnett Memorial Park, Lillington, North Carolina.
98. KENNETH MARVIN WATKINS (Davis' second cousin) was born on 10 April 1986, in Besty Johnson Memorial Hospital, Dunn, North Carolina, to Johnny Lee Watkins¹⁵⁹ and Sherry Lynne Watkins [Taylor]¹⁶⁰.
99. MATTHEW SHANE POOLE (Davis' second cousin) was born on 7 April 1987, in Besty Johnson Memorial Hospital, Dunn, North Carolina, to Ronnie Lynn Poole¹⁶⁴ and Bonnie Lou Poole [Watkins]¹⁶³.
100. FRANKIE WAYNE "RED BUG" CARROLL (Davis' third cousin) was born on 23 July 1952 to William Nathan "Mutt" Carroll¹⁷⁴ and Betty "Josephine" Carroll [Franks]¹⁷³. Frankie became known as "Red Bug". He died on 24 October 2014, aged 62. He was buried in Wake County, North Carolina.
101. JENNY CARROLL [NOBLING] (Davis' third cousin's wife).
 Frankie Wayne "Red Bug" Carroll¹⁰⁰ married Jenny Carroll [Nobling]. They had two children:
 Jeremy Wayne Carroll⁴⁹
 Jamie Barwick [Carroll]⁵⁰
 The following information is also recorded for this family. Widowed.
102. BRENDA BEASLEY [CARROLL] (Davis' third cousin) was born to William Nathan "Mutt" Carroll¹⁷⁴ and Betty "Josephine" Carroll [Franks]¹⁷³.
103. LISA M DOLAN [FRANKS] (Davis' third cousin) was born in 1966 to Michael Franks¹⁷⁶ and Gayle Franks [Hardy]¹⁷⁷.
104. SCOTT P FRANKS (Davis' third cousin) was born in 1970 to Michael Franks¹⁷⁶ and Gayle Franks [Hardy]¹⁷⁷.
105. DEBORAH LYNN HILL [DUPREE] (Davis' fourth cousin) was born in 1952 to John Elmond "J.E." Dupree Jr.¹⁸⁵ and Nancy Adeline Dupree [Dilday]¹⁸⁶.
106. ELIZABETH DUPREE (Davis' fourth cousin) was born in 1954 to John Elmond "J.E." Dupree Jr.¹⁸⁵ and Nancy Adeline Dupree [Dilday]¹⁸⁶.
107. RUTH PETREA [DUPREE] (Davis' fourth cousin) was born in 1955 to William Anguish "W.A." Dupree Jr.¹⁸⁷ and Joanna Catherine Dupree [Pttard]¹⁸⁸.

108. WILLIAM A DUPREE III (Davis' fourth cousin) was born in 1957 to William Anguish "W.A." Dupree Jr.¹⁸⁷ and Joanna Catherine Dupree [Pttard]¹⁸⁸.

Generation of Parents

109. DAVIS BRYANT WOODALL (Davis' father) was born on 7 January 1927 to Gilbert Chesley Woodall¹⁹⁶ and Alda Leland Woodall [Britt]¹⁹⁷, as shown in family tree 5. Davis was an Assistant Fire Chief, Fort Bragg, NC. He died (Congested Heart Failure) on 21 January 2015, aged 88, in Oak Hill Living Center, Angier, North Carolina. He was buried in Lakeside Memorial Gardens, Harnett County, North Carolina.
110. BETTY SUE WOODALL [DUPREE] (Davis' mother) was born on 21 February 1932 to John Stuart Dupree¹⁹⁸ and Ruby Larry Dupree [Franks]¹⁹⁹, as shown in family tree 6. Betty was a Postal Clerk. She died (Cardiac Arrest) on 22 December 2001, aged 69, in Good Hope Hospital Erwin, North Carolina. She was buried in Lakeside Memorial Gardens, Harnett County, North Carolina.
- Davis Bryant Woodall¹⁰⁹, aged 25, married Betty Sue Woodall [Dupree], aged 20, on 3 October 1952. They had two children:
- Davis Bryant "Dave" Woodall Jr.⁵¹ in 1953
Linda Kay Capps [Woodall]⁵³ in 1954
- The following information is also recorded for this family. Widowed.
This family is shown as family tree 4.
111. DORIS BRITT BUTTS [WOODALL] (Davis' aunt) was born on 24 January 1924 to Gilbert Chesley Woodall¹⁹⁶ and Alda Leland Woodall [Britt]¹⁹⁷, as shown in family tree 5. She died on 17 March 2009, aged 85, in E. Carlton Powell Hospice Center, Lillington, North Carolina. She was buried in Neil's Creek Baptist Church, Angier, North Carolina.
112. JAMES CLAYBORN BUTTS (Davis' uncle by marriage) was born on 7 June 1918. He died on 6 October 1986, aged 68. He was buried in Neil's Creek Baptist Church, Angier, North Carolina.
- James Clayborn Butts married Doris Britt Butts [Woodall]¹¹¹. They had two children:
- James Lenn Butts⁵⁵ in 1945
Leland Diane Chambers [Butts]⁵⁷ in 1948
113. FRANCES LORAIN DAVIS [WOODALL] (Davis' aunt) was born on 12 July 1925 to Gilbert Chesley Woodall¹⁹⁶ and Alda Leland Woodall [Britt]¹⁹⁷, as shown in family tree 5. She died on 17 January 2013, aged 87.
114. BILL ULYSSES DAVIS (Davis' uncle by marriage) was born on 28 June 1922, in Johnston County, North Carolina, to General William "Will" Davis⁶⁵⁸ and Ila Mae Davis [Talton]⁶⁵⁹. He died on 28 February 2018, aged 95, in SECU Hospice House, Smithfield, NC. He was buried in Cremated.
- [See also: Indirectly Related via Bill Ulysses Davis]*
- Bill Ulysses Davis married Frances Loraine Davis [Woodall]¹¹³. They had two sons:
- Robert Britt Davis⁵⁹ in 1946
Ronald Williard "Buddy" Davis⁶¹ in 1948
115. CHARLES LARRY DUPREE (Davis' uncle) was born on 27 March 1930 to John Stuart Dupree¹⁹⁸ and Ruby Larry Dupree [Franks]¹⁹⁹, as shown in family tree 6. Charles was a Trucker and Logger. He died (Cirrhosis of the liver) on 21 September 1969, aged 39. He was buried in Harnett Memorial Park, Lillington, North Carolina.
116. BILLIE JEAN DUPREE [STEPHENSON] (Davis' aunt by marriage) was born on 19 October 1933. She died (Poisoning - Self Inflicted) on 22 June 1965, aged 31. She was buried in Harnett Memorial Park, Lillington, North Carolina. Billie had two partnerships. She was married to Charles Larry Dupree¹¹⁵. She was also the partner of Mr. Sheets⁶⁶³.
- [See also: Indirectly Related via Billie Jean Dupree [Stephenson]]*
- Charles Larry Dupree¹¹⁵ married Billie Jean Dupree [Stephenson]. They had two children:
- Larry Gene Dupree⁶² in 1961
Rebecca Sue "Becky" Eason [Dupree]⁶³ in 1963
117. JOHN ROYSTER DUPREE (Davis' uncle) was born on 6 February 1935 to John Stuart Dupree¹⁹⁸ and Ruby Larry Dupree [Franks]¹⁹⁹, as shown in family tree 6. John was a Federal Aviation Administration, Washington, DC. He died on 16 November 2013, aged 78, in Summerton, South Carolina. He was buried in Lakeside Memorial Gardens, Harnett County, North Carolina.
118. JAMES LYNWOOD DUPREE (Davis' uncle) was born on 30 June 1942 to John Stuart Dupree¹⁹⁸ and Ruby Larry Dupree [Franks]¹⁹⁹, as shown in family tree 6. James became a Meter Reader with Progress Energy, Fuquay Varina, NC. James married twice. He was married to Larue Dupree [Williford]¹¹⁹ and Rachael Jane Dupree [Honeycutt]¹²⁰.
119. LARUE DUPREE [WILLIFORD] (Davis' aunt by marriage) was born on 15 February 1946.

James Lynwood Dupree¹¹⁸ married Larue Dupree [Williford], and they were divorced. They had one daughter:

Laura Lynn Honeycutt [Dupree]⁶⁵ in 1967

120. RACHAEL JANE DUPREE [HONEYCUTT] (Davis' aunt by marriage) was born on 14 August 1944. She died on 6 December 2020, aged 76, in Home. She was buried in Plainview.

Rachael married twice. She was married to James Lynwood Dupree¹¹⁸ and George Halford Barbour⁶⁶⁸.

[See also: Indirectly Related via Rachael Jane Dupree [Honeycutt]]

James Lynwood Dupree¹¹⁸, aged 48, married Rachael Jane Dupree [Honeycutt], aged 46, on 14 December 1990.

121. STUART RANDALL "RANDY" DUPREE (Davis' uncle) was born on 25 June 1950 to John Stuart Dupree¹⁹⁸ and Ruby Larry Dupree [Franks]¹⁹⁹, as shown in family tree 6. Stuart became known as "Randy". He died (Loss of Blood and Shock/Automobile Collision) on 23 November 1966, aged 16. He was buried in Young Family Cemetery on County Line Rd, Harnett County, North Carolina.

122. HUNTER MCGUIRE WOODALL JR. (Davis' cousin, once removed) was born on 14 June 1930 to Hunter McGuire Woodall²⁰⁰ and Fannie Lee Woodall [Goldston]²⁰¹. He died on 23 September 1993, aged 63.

123. SARAH FRANCIS WOODALL (Davis' cousin, once removed) was born on 1 January 1932 to Hunter McGuire Woodall²⁰⁰ and Fannie Lee Woodall [Goldston]²⁰¹. She is no longer living.

124. EDWARD WOODALL DEAN (Davis' cousin, once removed) was born in 1928 to Fred Edward Dean²⁰³ and Bettie Vandon Dean [Woodall]²⁰².

125. ANNIE DUKE DEAN [WHELESS] (Davis' cousin's wife, once removed) was born in 1928.

Edward Woodall Dean¹²⁴, aged about 22, married Annie Duke Dean [Wheless], aged about 22, on 17 June 1951 in Franklin, North Carolina.

126. BETTY LOU DEAN (Davis' cousin, once removed) was born on 4 October 1929 to Fred Edward Dean²⁰³ and Bettie Vandon Dean [Woodall]²⁰².

127. EDWARD HALE WOODALL II (Davis' cousin, once removed) was born on 3 March 1930 to Leigh Edward Woodall²⁰⁵ and Madeline Clyde Woodall [Hocutt]²⁰⁶. He died (enlarged heart) on 9 June 1934, aged 4.

128. MARTHA STELLA WOODALL (Davis' cousin, once removed) was born on 24 August 1932 to Leigh Edward Woodall²⁰⁵ and Madeline Clyde Woodall [Hocutt]²⁰⁶. She died (enlarged heart) on 24 January 1934, aged 1.

129. EDWARD MARSHALL WOODALL (Davis' cousin, once removed) was born on 4 February 1938 to Bert Albert Woodall²⁰⁷ and Candice Mozelle Woodall [Fish]²⁰⁸.

130. HAROLD BERT WOODALL (Davis' cousin, once removed) was born on 20 November 1942 to Bert Albert Woodall²⁰⁷ and Candice Mozelle Woodall [Fish]²⁰⁸. He died (Heart Failure) on 14 December 2015, aged 73.

131. SHELBY WOODALL [WEAVER] (Davis' cousin's wife, once removed).

Harold Bert Woodall¹³⁰ married Shelby Woodall [Weaver]. They had two sons:

Christopher Lee Woodall⁶⁷

Michael Scott Woodall⁶⁹

132. CAROLYN MURIEL BRADLEY (Davis' cousin, once removed) was born on 7 November 1936 to Rex Kenneth Bradley²¹¹ and Sallie Muriel Bradley [Woodall]²¹⁰.

133. REX KENNETH BRADLEY JR. (Davis' cousin, once removed) was born on 19 June 1939 to Rex Kenneth Bradley²¹¹ and Sallie Muriel Bradley [Woodall]²¹⁰. He died (Cancer) on 21 April 2013, aged 73. He was buried in Lafayette Memorial Park Fayetteville, North Carolina.

134. EVELYN BRADLEY [PLEASANT] (Davis' cousin's wife, once removed) was born in 1942. She died on 4 February 2005, aged about 62.

Rex Kenneth Bradley Jr.¹³³ married Evelyn Bradley [Pleasant]. They had two daughters:

Robin Jackson [Bradley]⁷¹ in 1969

Kerry Lyn Beaver [Bradley]⁷³ in 1973

135. JERRY MAC BRADLEY (Davis' cousin, once removed) was born on 25 November 1944 to Rex Kenneth Bradley²¹¹ and Sallie Muriel Bradley [Woodall]²¹⁰.

136. JANE BRADLEY [S] (Davis' cousin's wife, once removed) was born in 1953.

Jerry Mac Bradley¹³⁵ married Jane Bradley [S]. They had three children:
 Clare Melissa Bradley⁷⁵ in 1980
 Rex Bradley⁷⁶ in 1981
 Leeann M Bradley⁷⁷ in 1988

137. STACY LEE DUPREE (Davis' cousin, once removed) was born on 22 July 1929 to Ottis Alden Dupree²¹⁷ and Myrtle Irene Dupree [Stephenson]²¹⁸. He died in 1981, aged about 51.
138. DORIS PEARL DUPREE [WILKERSON] (Davis' cousin's wife, once removed) was born on 22 September 1930. She died on 21 December 1994, aged 64. She was buried in Lakeside Memorial Gardens, Harnett County, North Carolina.
 Stacy Lee Dupree¹³⁷, aged 21, married Doris Pearl Dupree [Wilkerson], aged 20, on 31 March 1951. They had three children:
 Kathy Lynn Rowe [Dupree]⁷⁸ in 1952
 Gary Ken Dupree⁸⁰ in 1955
 Larry Glenn Dupree⁸² in 1955
139. SHIRLEY ANN FUQUAY [DUPREE] (Davis' cousin, once removed) was born on 22 May 1934 to Ottis Alden Dupree²¹⁷ and Myrtle Irene Dupree [Stephenson]²¹⁸. She died on 26 April 1992, aged 57.
140. CECIL ADAIR FUQUAY (Davis' cousin's partner, once removed) was born on 9 September 1923. He died on 23 August 2013, aged 89.
 Cecil Adair Fuquay and Shirley Ann Fuquay [Dupree]¹³⁹ had one daughter:
 Lisa Ann Fuquay⁸⁴ in 1960
 The following information is also recorded for this family. Friends; Widowed.
141. DONNIE RAY DUPREE (Davis' cousin, once removed) was born on 30 December 1942 to Ottis Alden Dupree²¹⁷ and Myrtle Irene Dupree [Stephenson]²¹⁸. He died (Lung Cancer) on 18 March 2019, aged 76. He was buried in Lancaster Memorial Park Mausoleum Louisburg, NC.
 Donnie married four times. He was married to Mamie Lou Dupree [Johnson]¹⁴², Linda Carol Dupree [Glasgow]¹⁴³, Betty Carolyn Dupree [Radford]¹⁴⁴ and Shirley Dupree [Murphy]¹⁴⁵.
142. MAMIE LOU DUPREE [JOHNSON] (Davis' cousin's wife, once removed).
 Donnie Ray Dupree¹⁴¹, aged 18, married Mamie Lou Dupree [Johnson] on 23 November 1961.
143. LINDA CAROL DUPREE [GLASGOW] (Davis' cousin's wife, once removed) was born in 1947.
 Donnie Ray Dupree¹⁴¹, aged 22, married Linda Carol Dupree [Glasgow], aged about 18, on 2 October 1965, and they were divorced. They had one son:
 Kevin Ray Dupree⁸⁵ in 1967
144. BETTY CAROLYN DUPREE [RADFORD] (Davis' cousin's wife, once removed) was born in 1943.
 Donnie Ray Dupree¹⁴¹, aged about 29, married Betty Carolyn Dupree [Radford], aged about 29, in 1972, and they were divorced.
145. SHIRLEY DUPREE [MURPHY] (Davis' cousin's wife, once removed) was born on 18 June 1954.
 Donnie Ray Dupree¹⁴¹, aged 44, married Shirley Dupree [Murphy], aged 32, on 21 February 1987.
146. JAMES "WILBURN" DUPREE (Davis' cousin, once removed) was born on 15 May 1922 to Dorsey Benard Dupree²¹⁹ and Mallie Dupree [Ennis]²²⁰. James became known as "Wilburn". James was a Carpenter. He died on 17 February 1998, aged 75.
147. ETHOLEA DUPREE [HARDEE] (Davis' cousin's wife, once removed) was born on 15 February 1928. She died on 9 June 2006, aged 78.
 James "Wilburn" Dupree¹⁴⁶, aged 26, married Etholea Dupree [Hardee], aged 20, on 13 November 1948. They had one daughter:
 Susan "Elaine" Price [Dupree]⁸⁷ in 1951
148. SUSAN EVELYN O'NEAL [DUPREE] (Davis' cousin, once removed) was born on 31 March 1927 to Dorsey Benard Dupree²¹⁹ and Mallie Dupree [Ennis]²²⁰. She died on 9 September 2014, aged 87.
149. PATSY ENNIS O'NEAL [DUPREE] (Davis' cousin, once removed) was born on 29 July 1929 to Dorsey Benard Dupree²¹⁹ and Mallie Dupree [Ennis]²²⁰. She died on 27 January 2004, aged 74. She was buried in Lakeside Memorial Gardens, Harnett County, North Carolina.
150. HERMAN DENNIS O'NEAL (Davis' cousin's husband, once removed) was born on 5 November 1934.
 Herman Dennis O'Neal, aged 22, married Patsy Ennis O'Neal [Dupree]¹⁴⁹, aged 27, on 12 July 1957, and they were divorced. They had three sons:
 Dennis Alan O'Neal⁹¹ in 1959
 Terry Lee O'Neal⁹² in 1960
 Mark Andrew O'Neal⁹³ in 1967

151. THOMAS LAYTON DUPREE (Davis' cousin, once removed) was born on 11 September 1932 to Dorsey Benard Dupree²¹⁹ and Mallie Dupree [Ennis]²²⁰.
152. MARY LYNN DUPREE [SMITH] (Davis' cousin's wife, once removed) was born on 25 April 1937. She died on 5 October 2003, aged 66.
 Thomas Layton Dupree¹⁵¹ married Mary Lynn Dupree [Smith]. They had three children:
 Tammy Richelle Ferebee [Dupree]⁹⁴ in 1962
 Barry Sherman Dupree⁹⁵ in 1964
 Heather Dawn Marler [Dupree]⁹⁶ in 1975
 The following information is also recorded for this family. Widowed.
153. RAYTHELL GREENE ADAMS (Davis' cousin, once removed) was born on 17 February 1928 to Silas Greene Adams²²² and Ila Ann Adams [Dupree]²²¹. He died on 27 September 2010, aged 82. He was buried in Harnett Memorial Park, Lillington, North Carolina.
154. EMILY ADAMS [BLANCHARD] (Davis' cousin's wife, once removed) was born on 29 September 1930. She died on 18 April 2016, aged 85, in Angier, North Carolina. She was buried in Harnett Memorial Park, Lillington, North Carolina.
 Raythell Greene Adams¹⁵³ married Emily Adams [Blanchard]. They had one son:
 Joseph Ronald "Ronnie" Adams⁹⁷ in 1955
155. JOSEPH GERALD "BUTCH" ADAMS (Davis' cousin, once removed) was born on 4 March 1932 to Silas Greene Adams²²² and Ila Ann Adams [Dupree]²²¹. Joseph became known as "Butch". He died on 13 September 1997, aged 65. He was buried in Bethel Primitive Baptist Church Cemetery, Johnston County, North Carolina.
156. JEAN CAROLINE LEE [ADAMS] (Davis' cousin, once removed) was born on 28 February 1938 to Silas Greene Adams²²² and Ila Ann Adams [Dupree]²²¹.
157. MARTHA REBECCA CREECH (Davis' cousin, once removed) was born on 9 September 1928 to Wayman Creech²²⁶ and Lois Creech [Dupree]²²⁵. She died on 29 November 1992, aged 64.
158. DALEY GLENN DUPREE (Davis' cousin, once removed, via adoption) was born on 23 September 1955. Daley was adopted by Charles Glenn Dupree²²⁷ and Clara Emily Dupree [Denning]²²⁸. He died (motorcycle accident) on 13 August 1973, aged 17. He was buried in Bethel Primitive Baptist Church Cemetery, Johnston County, North Carolina.
159. JOHNNY LEE WATKINS (Davis' cousin, once removed) was born on 30 March 1947 to CPL Kenneth Lee Watkins²²⁹ and Virginia Grace Watkins [Matthews]²³⁰.
160. SHERRY LYNNE WATKINS [TAYLOR] (Davis' cousin's wife, once removed) was born in Virginia.
 Johnny Lee Watkins¹⁵⁹ married Sherry Lynne Watkins [Taylor], and they were divorced. They had one son:
 Kenneth Marvin Watkins⁹⁸ in 1986
161. BETTY GRACE BARNES [WATKINS] (Davis' cousin, once removed) was born on 22 July 1950 to CPL Kenneth Lee Watkins²²⁹ and Virginia Grace Watkins [Matthews]²³⁰.
162. DAVID BARNES (Davis' cousin's husband, once removed).
 David Barnes married Betty Grace Barnes [Watkins]¹⁶¹.
163. BONNIE LOU POOLE [WATKINS] (Davis' cousin, once removed) was born on 24 September 1954 to CPL Kenneth Lee Watkins²²⁹ and Virginia Grace Watkins [Matthews]²³⁰. She died (Died in sleep two days after stent put in throat) on 25 March 2017, aged 62, in At sons home. She was buried in Cremated.
164. RONNIE LYNN POOLE (Davis' cousin's husband, once removed) was born on 26 February 1961.
 Ronnie Lynn Poole married Bonnie Lou Poole [Watkins]¹⁶³, and they were divorced. They had one son:
 Matthew Shane Poole⁹⁹ in 1987
165. SUSAN MATTHEW THOMPSON [WATKINS] (Davis' cousin, once removed) was born on 29 March 1960 to CPL Kenneth Lee Watkins²²⁹ and Virginia Grace Watkins [Matthews]²³⁰.
166. GARLAND THOMPSON (Davis' cousin's husband, once removed).
 Garland Thompson married Susan Matthew Thompson [Watkins]¹⁶⁵.
167. DANIEL PARKER "DANNY" WATKINS JR. (Davis' cousin, once removed) was born on 7 May 1953 to Daniel Parker "Danny" Watkins²³² and Carolyn Watkins [Johnson]²³³. Daniel became known as "Danny".
168. DEBBIE ADCOCK [WATKINS] (Davis' cousin, once removed) was born to Daniel Parker "Danny" Watkins²³² and Carolyn Watkins [Johnson]²³³.

169. DAVID WATKINS (Davis' cousin, once removed) was born to Daniel Parker "Danny" Watkins²³² and Carolyn Watkins [Johnson]²³³.
170. WILLIAM TAYLOR "BILLY" WATKINS (Davis' cousin, once removed) was born on 23 January 1947 to William Marshburn "Bill" Watkins²³⁵ and Eira Watkins [Taylor]²³⁶. William became known as "Billy". He died (Car Wreck on Ashe Ave, Dunn, NC) on 13 November 1964, aged 17, in Dunn, NC. He was buried in Angier Primitive Baptist Church, Angier, North Carolina.
171. TIMOTHY MARSHBURN "TIMMY" WATKINS (Davis' cousin, once removed) was born on 26 September 1956 to William Marshburn "Bill" Watkins²³⁵ and Eira Watkins [Taylor]²³⁶. Timothy became known as "Timmy". He died (Drug Overdose) on 26 April 1975, aged 18. He was buried in Angier Primitive Baptist Church, Angier, North Carolina.
172. SUSAN JONES (Davis' cousin, once removed) was born to Gordon Jones²³⁸ and Ida Jones [Watkins]²³⁷.
173. BETTY "JOSEPHINE" CARROLL [FRANKS] (Davis' second cousin, once removed) was born on 3 February 1926 to "Graham" Hubbard Franks²⁴¹ and Bettie Allene Franks [Barbour]²⁴². Betty became known as "Josephine". She died on 31 March 1999, aged 73. She was buried in Montlawn Memorial Park, Raleigh, North Carolina.
174. WILLIAM NATHAN "MUTT" CARROLL (Davis' second cousin's husband, once removed) was born on 27 March 1920. William became known as "Mutt". He died on 20 March 1983, aged 62. He was buried in Montlawn Memorial Park, Raleigh, North Carolina.
William Nathan "Mutt" Carroll, aged 26, married Betty "Josephine" Carroll [Franks]¹⁷³, aged 20, on 9 August 1946. They had two children:
Frankie Wayne "Red Bug" Carroll¹⁰⁰ in 1952
Brenda Beasley [Carroll]¹⁰²
175. "DONALD" RAY FRANKS (Davis' second cousin, once removed) was born on 27 June 1945 to "Graham" Hubbard Franks²⁴¹ and Bettie Allene Franks [Barbour]²⁴². "Donald" became known as "Donald".
176. MICHAEL FRANKS (Davis' second cousin, once removed) was born on 22 October 1946 to Luther Warren Franks²⁴³ and Kathleen Franks [Humphries]²⁴⁴.
Michael married twice. He was married to Gayle Franks [Hardy]¹⁷⁷ and Janet Lynne Franks [Swiger]¹⁷⁸.
177. GAYLE FRANKS [HARDY] (Davis' second cousin's wife, once removed) was born in 1946.
Michael Franks¹⁷⁶ married Gayle Franks [Hardy], and they were divorced. They had two children:
Lisa M Dolan [Franks]¹⁰³ in 1966
Scott P Franks¹⁰⁴ in 1970
178. JANET LYNNE FRANKS [SWIGER] (Davis' second cousin's wife, once removed) was born on 21 March 1957.
Janet married twice. She was married to Michael Franks¹⁷⁶ and Jonathan Lemoyne Rose⁶⁷³.
[See also: Indirectly Related via Janet Lynne Franks [Swiger]]
Michael Franks¹⁷⁶ married Janet Lynne Franks [Swiger].
179. CLAUDIA RUTH BAKER (Davis' second cousin, once removed) was born in 1957 to Claude Leroy Baker²⁴⁸ and Ruth Emma Baker [Franks]²⁴⁷.
180. ELIZABETH ELLEN "BETH" WOODALL (Davis' third cousin, once removed) was born on 17 August 1941 to Dewitt Creech Woodall²⁴⁹ and Leah Elizabeth Woodall [Alley]²⁵⁰. Elizabeth became known as "Beth".
181. DEWITT CREECH "WOODY" WOODALL JR. (Davis' third cousin, once removed) was born on 14 March 1943 to Dewitt Creech Woodall²⁴⁹ and Leah Elizabeth Woodall [Alley]²⁵⁰. Dewitt became known as "Woody".
182. MARY WOODALL [OLIVE] (Davis' third cousin's wife, once removed) was born in 1947.
Dewitt Creech "Woody" Woodall Jr.¹⁸¹, aged 38, married Mary Woodall [Olive], aged about 34, on 14 November 1981.
183. FRANK ALLEY "AL" WOODALL (Davis' third cousin, once removed) was born on 7 December 1945, in Harnett County, North Carolina, to Dewitt Creech Woodall²⁴⁹ and Leah Elizabeth Woodall [Alley]²⁵⁰. Frank became known as "Al". Frank was educated (Duke University). He became a Retired Professional Football Player.
Note: *Duke University football All-American.*
184. JACKIE WOODALL (Davis' third cousin's wife, once removed).
Frank Alley "Al" Woodall¹⁸³ married Jackie Woodall.
185. JOHN ELMOND "J.E." DUPREE JR. (Davis' third cousin, once removed) was born on 19 September 1928 to John Elmond Dupree Sr.²⁵¹ and Mattie Dupree [Brickhouse]²⁵². John became known as "J.E.". He died on 9 September 1992, aged 63.

186. NANCY ADELIN DUPREE [DILDAY] (Davis' third cousin's wife, once removed) was born on 22 September 1927. She died on 3 July 2017, aged 89.
 John Elmond "J.E." Dupree Jr.¹⁸⁵ married Nancy Adeline Dupree [Dilday]. They had two daughters:
 Deborah Lynn Hill [Dupree]¹⁰⁵ in 1952
 Elizabeth Dupree¹⁰⁶ in 1954
187. WILLIAM ANGUISH "W.A." DUPREE JR. (Davis' third cousin, once removed) was born on 26 December 1928 to William Anguish Dupree Sr.²⁵³ and Ruth Naola Dupree²⁵⁴. William became known as "W.A.". He died on 16 January 1999, aged 70, in Montlawn Memorial Park, Raleigh, Wake Co, NC.
188. JOANNA CATHERINE DUPREE [PTTTARD] (Davis' third cousin's wife, once removed) was born on 14 March 1929. She died on 14 April 1998, aged 69.
 William Anguish "W.A." Dupree Jr.¹⁸⁷ married Joanna Catherine Dupree [Pttard]. They had two children:
 Ruth Petrea [Dupree]¹⁰⁷ in 1955
 William A Dupree III¹⁰⁸ in 1957
189. DONNA KAY GASKIN [DUPREE] (Davis' fourth cousin, once removed) was born in 1944 to Alvis Holton Dupree²⁵⁵ and Clyda Dupree [Young]²⁵⁶.
190. RONALD HOLTON DUPREE (Davis' fourth cousin, once removed) was born on 17 May 1945 to Alvis Holton Dupree²⁵⁵ and Clyda Dupree [Young]²⁵⁶.
191. JOHNNY LEE DUPREE (Davis' fourth cousin, once removed) was born in 1947 to Alvis Holton Dupree²⁵⁵ and Clyda Dupree [Young]²⁵⁶.
192. JANET DOANE ADAMS [DUPREE] (Davis' fourth cousin, once removed) was born on 29 December 1951 to Alvis Holton Dupree²⁵⁵ and Clyda Dupree [Young]²⁵⁶.
193. JANET LYNN WHITE [DUPREE] (Davis' fourth cousin, once removed) was born in 1949 to Harry Clay Dupree²⁵⁹ and Blanche William Dupree [Ogburn]²⁶⁰.
194. JOAN ELIZABETH BLALOCK [DUPREE] (Davis' fourth cousin, once removed) was born on 11 January 1951 to Harry Clay Dupree²⁵⁹ and Blanche William Dupree [Ogburn]²⁶⁰.
195. BEVERLY CLAY DAVIS [DUPREE] (Davis' fourth cousin, once removed) was born on 8 March 1955 to Harry Clay Dupree²⁵⁹ and Blanche William Dupree [Ogburn]²⁶⁰.

Generation of Grandparents

196. GILBERT CHESLEY WOODALL (Davis' grandfather) was born on 29 November 1893, in Johnston County, North Carolina, to Edward Hale Woodall²⁶¹ and Sarah Woodall [Lee]²⁶², as shown in family tree 7. Gilbert was a Carpenter. He died on 24 December 1978, aged 85, in Veterans Hospital Fayetteville, North Carolina. He was buried in Harnett Memorial Park, Lillington, North Carolina.
197. ALDA LELAND WOODALL [BRITT] (Davis' grandmother) was born on 18 April 1898, in North Carolina, to Leonard Lethco Britt²⁶³ and Mary Francis Britt [Guy]²⁶⁴, as shown in family tree 8. She died on 12 July 1930, aged 32. She was buried in Harnett Memorial Park, Lillington, North Carolina.
 Gilbert Chesley Woodall¹⁹⁶, aged 29, married Alda Leland Woodall [Britt], aged 24, on 6 December 1922. They had three children:
 Doris Britt Butts [Woodall]¹¹¹ in 1924
 Frances Loraine Davis [Woodall]¹¹³ in 1925
 Davis Bryant Woodall¹⁰⁹ in 1927
This family is shown as family tree 5.
198. JOHN STUART DUPREE (Davis' grandfather) was born on 9 June 1902 to Charlie Benton Dupree²⁶⁵ and Martha Caroline Dupree [Young]²⁶⁶, as shown in family tree 9. John was a Farmer. He died on 23 July 1976, aged 74, in Raleigh, North Carolina. He was buried in Lakeside Memorial Gardens, Harnett County, North Carolina.
199. RUBY LARRY DUPREE [FRANKS] (Davis' grandmother) was born on 20 April 1913, in Wake County, North Carolina, to Robert Larry Franks²⁶⁷ and Vienna Jannetta Franks [Marshburn]²⁶⁸, as shown in family tree 10. Ruby was a Farmer, sold milk, butter and eggs. She died (Cardiac Arrest) on 16 September 2004, aged 91, in Britthaven in Dunn, North Carolina. She was buried in Lakeside Memorial Gardens, Harnett County, North Carolina.

John Stuart Dupree¹⁹⁸, aged 26, married Ruby Larry Dupree [Franks], aged 15, on 15 December 1928. They had five children:

Charles Larry Dupree¹¹⁵ in 1930
 Betty Sue Woodall [Dupree]¹¹⁰ in 1932
 John Royster Dupree¹¹⁷ in 1935
 James Lynwood Dupree¹¹⁸ in 1942
 Stuart Randall "Randy" Dupree¹²¹ in 1950

The following information is also recorded for this family. Widowed.

This family is shown as family tree 6.

200. HUNTER MCGUIRE WOODALL (Davis' great-uncle) was born on 3 March 1896, in Johnston County, North Carolina, to Edward Hale Woodall²⁶¹ and Sarah Woodall [Lee]²⁶², as shown in family tree 7. Hunter was a Mechanic CP&L. He died on 18 April 1981, aged 85.
201. FANNIE LEE WOODALL [GOLDSTON] (Davis' great-aunt by marriage) was born on 28 January 1898, in Lee County, North Carolina. She died in March 1978, aged 80.
 Hunter McGuire Woodall²⁰⁰, aged 30, married Fannie Lee Woodall [Goldston], aged 28, on 3 April 1926. They had two children:
 Hunter McGuire Woodall Jr.¹²² in 1930
 Sarah Francis Woodall¹²³ in 1932
202. BETTIE VANDON DEAN [WOODALL] (Davis' great-aunt) was born on 2 April 1898, in Johnston County, North Carolina, to Edward Hale Woodall²⁶¹ and Sarah Woodall [Lee]²⁶², as shown in family tree 7. She died on 18 May 1997, aged 99.
203. FRED EDWARD DEAN (Davis' great-uncle by marriage) was born on 19 April 1899, in Franklin County, North Carolina. He died in June 1979, aged 80.
 Fred Edward Dean, aged 26, married Bettie Vandon Dean [Woodall]²⁰², aged 27, on 21 December 1925. They had two children:
 Edward Woodall Dean¹²⁴ in 1928
 Betty Lou Dean¹²⁶ in 1929
204. CLIDA LEE WOODALL (Davis' great-aunt) was born on 28 September 1901, in Johnston County, North Carolina, to Edward Hale Woodall²⁶¹ and Sarah Woodall [Lee]²⁶², as shown in family tree 7. She died on 7 March 1949, aged 47. She was buried in Harnett Memorial Park, Lillington, North Carolina.
205. LEIGH EDWARD WOODALL (Davis' great-uncle) was born on 2 July 1903, in Johnston County, North Carolina, to Edward Hale Woodall²⁶¹ and Sarah Woodall [Lee]²⁶², as shown in family tree 7. Leigh was a Salesman. He died (Heart attack after saving girl from drowning at the beach) on 14 July 1949, aged 46.
206. MADELINE CLYDE WOODALL [HOCUTT] (Davis' great-aunt by marriage) was born on 2 May 1898, in Wake County, North Carolina. She is no longer living.
 Leigh Edward Woodall²⁰⁵ married Madeline Clyde Woodall [Hocutt]. They had two children:
 Edward Hale Woodall II¹²⁷ in 1930
 Martha Stella Woodall¹²⁸ in 1932
207. BERT ALBERT WOODALL (Davis' great-uncle) was born on 31 August 1906, in Johnston County, North Carolina, to Edward Hale Woodall²⁶¹ and Sarah Woodall [Lee]²⁶², as shown in family tree 7. He died on 26 July 1981, aged 74. He was buried in Harnett Memorial Park, Lillington, North Carolina.
208. CANDICE MOZELLE WOODALL [FISH] (Davis' great-aunt by marriage) was born on 14 November 1909. She died on 27 January 1994, aged 84. She was buried in Harnett Memorial Park, Lillington, North Carolina.
 Bert Albert Woodall²⁰⁷ married Candice Mozelle Woodall [Fish]. They had two sons:
 Edward Marshall Woodall¹²⁹ in 1938
 Harold Bert Woodall¹³⁰ in 1942
209. WILLIS LESTER WOODALL (Davis' great-uncle) was born on 7 March 1910, in Johnston County, North Carolina, to Edward Hale Woodall²⁶¹ and Sarah Woodall [Lee]²⁶², as shown in family tree 7. Willis was a Television and Radio repairman. He died on 19 September 1958, aged 48.
210. SALLIE MURIEL BRADLEY [WOODALL] (Davis' great-aunt) was born on 17 June 1913, in Johnston County, North Carolina, to Edward Hale Woodall²⁶¹ and Sarah Woodall [Lee]²⁶², as shown in family tree 7. She died on 28 August 2008, aged 95. She was buried in Rawls Church Baptist Church Cemetary, Harnett County, North Carolina.
211. REX KENNETH BRADLEY (Davis' great-uncle by marriage) was born on 29 November 1909. He died on 7 September 2000, aged 90. He was buried in Rawls Church Baptist Church Cemetary, Harnett County, North Carolina.

Rex Kenneth Bradley married Sallie Muriel Bradley [Woodall]²¹⁰. They had three children:
 Carolyn Muriel Bradley¹³² in 1936
 Rex Kenneth Bradley Jr.¹³³ in 1939
 Jerry Mac Bradley¹³⁵ in 1944

212. ANNIE SEXTON [BRITT] (Davis' great-aunt) was born on 3 June 1893 to Leonard Lethco Britt²⁶³ and Mary Francis Britt [Guy]²⁶⁴, as shown in family tree 8. She died on 6 July 1986, aged 93. She was buried in Harnett Memorial Park, Lillington, North Carolina.
213. ILA BRITT (Davis' great-aunt) was born on 24 May 1896 to Leonard Lethco Britt²⁶³ and Mary Francis Britt [Guy]²⁶⁴, as shown in family tree 8. She died on 10 May 1979, aged 82. She was buried in Harnett Memorial Park, Lillington, North Carolina.
214. RADO UTAH ENNIS [BRITT] (Davis' great-aunt) was born on 30 October 1899 to Leonard Lethco Britt²⁶³ and Mary Francis Britt [Guy]²⁶⁴, as shown in family tree 8. She died on 12 April 1980, aged 80. She was buried in Harnett Memorial Park, Lillington, North Carolina.
215. BROUGHTON C BRITT (Davis' great-uncle) was born on 6 July 1902 to Leonard Lethco Britt²⁶³ and Mary Francis Britt [Guy]²⁶⁴, as shown in family tree 8. He died on 20 June 1958, aged 55. He was buried in Harnett Memorial Park, Lillington, North Carolina.
216. IRA BRITT (Davis' great-uncle) was born to Leonard Lethco Britt²⁶³ and Mary Francis Britt [Guy]²⁶⁴, as shown in family tree 8. He is no longer living.
217. OTTIS ALDEN DUPREE (Davis' great-uncle) was born on 8 October 1892 to Charlie Benton Dupree²⁶⁵ and Martha Caroline Dupree [Young]²⁶⁶, as shown in family tree 9. Ottis was a Farmer. He died (Cerebrovascular accident "Stroke") on 4 August 1971, aged 78, in Harnett County, North Carolina. He was buried in Lakeside Memorial Gardens, Harnett County, North Carolina.
218. MYRTLE IRENE DUPREE [STEPHENSON] (Davis' great-aunt by marriage) was born in 1905. She died in 1970, aged about 65.
 Ottis Alden Dupree²¹⁷, aged 35, married Myrtle Irene Dupree [Stephenson], aged about 22, on 24 December 1927. They had three children:
 Stacy Lee Dupree¹³⁷ in 1929
 Shirley Ann Fuquay [Dupree]¹³⁹ in 1934
 Donnie Ray Dupree¹⁴¹ in 1942
219. DORSEY BENARD DUPREE (Davis' great-uncle) was born on 6 May 1894 to Charlie Benton Dupree²⁶⁵ and Martha Caroline Dupree [Young]²⁶⁶, as shown in family tree 9. He died on 22 April 1969, aged 74.
220. MALLIE DUPREE [ENNIS] (Davis' great-aunt by marriage) was born on 2 March 1898. She died on 27 December 1978, aged 80.
 Dorsey Benard Dupree²¹⁹ married Mallie Dupree [Ennis]. They had four children:
 James "Wilburn" Dupree¹⁴⁶ in 1922
 Susan Evelyn O'Neal [Dupree]¹⁴⁸ in 1927
 Patsy Ennis O'Neal [Dupree]¹⁴⁹ in 1929
 Thomas Layton Dupree¹⁵¹ in 1932
221. ILA ANN ADAMS [DUPREE] (Davis' great-aunt) was born on 28 September 1896 to Charlie Benton Dupree²⁶⁵ and Martha Caroline Dupree [Young]²⁶⁶, as shown in family tree 9. She died on 4 April 1971, aged 74. She was buried in Bethel Primitive Baptist Church Cemetery, Johnston County, North Carolina.
222. SILAS GREENE ADAMS (Davis' great-uncle by marriage) was born on 8 June 1898. He died on 24 March 1951, aged 52. He was buried in Bethel Primitive Baptist Church Cemetery, Johnston County, North Carolina.
 Silas Greene Adams, aged 26, married Ila Ann Adams [Dupree]²²¹, aged 28, on 9 May 1925. They had three children:
 Raythell Greene Adams¹⁵³ in 1928
 Joseph Gerald "Butch" Adams¹⁵⁵ in 1932
 Jean Caroline Lee [Adams]¹⁵⁶ in 1938
223. CARY MELVIN DUPREE (Davis' great-uncle) was born on 22 June 1899 to Charlie Benton Dupree²⁶⁵ and Martha Caroline Dupree [Young]²⁶⁶, as shown in family tree 9. He died on 16 May 1981, aged 81. He was buried in Montlawn Memorial Park, Raleigh, North Carolina.
224. MILDRED DUPREE [JONES] (Davis' great-aunt by marriage) was born on 9 April 1902. She died (shot in the head four times by four men at home during robbery) on 11 December 1959, aged 57, in Angier, North Carolina.

Cary Melvin Dupree²²³ married Mildred Dupree [Jones].

225. LOIS CREECH [DUPREE] (Davis' great-aunt) was born about 1906 to Charlie Benton Dupree²⁶⁵ and Martha Caroline Dupree [Young]²⁶⁶, as shown in family tree 9. She is no longer living.
226. WAYMAN CREECH (Davis' great-uncle by marriage) was born about 1904. He is no longer living.
Wayman Creech married Lois Creech [Dupree]²²⁵. They had one daughter:
Martha Rebecca Creech¹⁵⁷ in 1928
227. CHARLES GLENN DUPREE (Davis' great-uncle) was born on 23 March 1911 to Charlie Benton Dupree²⁶⁵ and Martha Caroline Dupree [Young]²⁶⁶, as shown in family tree 9. He died on 8 August 1963, aged 52. He was buried in Bethel Primitive Baptist Church Cemetery, Johnston County, North Carolina.
228. CLARA EMILY DUPREE [DENNING] (Davis' great-aunt by marriage) was born on 25 February 1914. She died on 1 April 1980, aged 66, in Good Hope Hospital Erwin, North Carolina. She was buried in Bethel Primitive Baptist Church Cemetery, Johnston County, North Carolina.
Charles Glenn Dupree²²⁷ married Clara Emily Dupree [Denning]. They assumed parenthood of one son:
Daley Glenn Dupree¹⁵⁸ by adoption
229. CPL KENNETH LEE WATKINS (Davis' great-uncle) was born on 5 August 1926 to William Adderson Watkins²⁶⁹ and Vienna Jannetta Franks [Marshburn]²⁶⁸. He died (House Fire) on 18 November 1971, aged 45. He was buried in Lakeside Memorial Gardens, Harnett County, North Carolina.
CPL married twice. He was married to Virginia Grace Watkins [Matthews]²³⁰ and Shirley Faye Watkins [Wilkerson]²³¹.
Note: *CPL US Army WWII*.
230. VIRGINIA GRACE WATKINS [MATTHEWS] (Davis' great-aunt by marriage) was born on 4 December 1928. She died on 12 December 2018, aged 90, in Harnett Woods Nursing Home Dunn, NC.
CPL Kenneth Lee Watkins²²⁹ married Virginia Grace Watkins [Matthews], and they were divorced. They had four children:
Johnny Lee Watkins¹⁵⁹ in 1947
Betty Grace Barnes [Watkins]¹⁶¹ in 1950
Bonnie Lou Poole [Watkins]¹⁶³ in 1954
Susan Matthew Thompson [Watkins]¹⁶⁵ in 1960
231. SHIRLEY FAYE WATKINS [WILKERSON] (Davis' great-aunt by marriage) was born on 10 March 1937. She died on 16 October 2000, aged 63. She was buried in Lakeside Memorial Gardens, Harnett County, North Carolina.
CPL Kenneth Lee Watkins²²⁹, aged 42, married Shirley Faye Watkins [Wilkerson], aged 31, on 22 February 1969.
232. DANIEL PARKER "DANNY" WATKINS (Davis' great-uncle) was born on 3 September 1928 to William Adderson Watkins²⁶⁹ and Vienna Jannetta Franks [Marshburn]²⁶⁸. Daniel became known as "Danny". He died on 20 July 2011, aged 82. He was buried in Lakeside Memorial Gardens, Harnett County, North Carolina.
Daniel married twice. He was married to Carolyn Watkins [Johnson]²³³ and Barbara Jean Watkins [Davis]²³⁴.
233. CAROLYN WATKINS [JOHNSON] (Davis' great-aunt by marriage) was born on 24 November 1931. She died (Cancer) on 4 June 1999, aged 67. She was buried in Lakeside Memorial Gardens, Harnett County, North Carolina.
Daniel Parker "Danny" Watkins²³² married Carolyn Watkins [Johnson]. They had three children:
Daniel Parker "Danny" Watkins Jr.¹⁶⁷ in 1953
Debbie Adcock [Watkins]¹⁶⁸
David Watkins¹⁶⁹
234. BARBARA JEAN WATKINS [DAVIS] (Davis' great-aunt by marriage).
Daniel Parker "Danny" Watkins²³², aged 77, married Barbara Jean Watkins [Davis] on 31 July 2006.
235. WILLIAM MARSHBURN "BILL" WATKINS (Davis' great-uncle) was born on 29 May 1929 to William Adderson Watkins²⁶⁹ and Vienna Jannetta Franks [Marshburn]²⁶⁸. William became known as "Bill". He died on 29 February 2004, aged 74. He was buried in Angier Primitive Baptist Church, Angier, North Carolina.
236. EIRA WATKINS [TAYLOR] (Davis' great-aunt by marriage) was born on 21 March 1924, in Harnett County, North Carolina. She died on 31 July 2018, aged 94. She was buried in Angier Primitive Baptist Church Cemetery.
William Marshburn "Bill" Watkins²³⁵ married Eira Watkins [Taylor]. They had two sons:
William Taylor "Billy" Watkins¹⁷⁰ in 1947
Timothy Marshburn "Timmy" Watkins¹⁷¹ in 1956
237. IDA JONES [WATKINS] (Davis' great-aunt) was born to William Adderson Watkins²⁶⁹ and Vienna Jannetta Franks [Marshburn]²⁶⁸. She died on 12 December 1966.
238. GORDON JONES (Davis' great-uncle by marriage). He is no longer living.

Gordon Jones married Ida Jones [Watkins]²³⁷. They had one daughter:
Susan Jones¹⁷²

239. KATE WOODALL (Davis' cousin, twice removed) was born to Willis L. Woodall²⁷⁰ and Cornelia Woodall²⁷¹.
240. HUBERT C WOODALL (Davis' cousin, twice removed) was born to Willis L. Woodall²⁷⁰ and Cornelia Woodall²⁷¹.
241. "GRAHAM" HUBBARD FRANKS (Davis' cousin, twice removed) was born on 8 June 1906 to Samuel "Lattie" Franks²⁸² and Bettie Perry Franks [Spears]²⁸³. "Graham" became known as "Graham". He died on 14 May 1983, aged 76. He was buried in Mount Zion United Methodist Church, Johnston County.
242. BETTIE ALLENE FRANKS [BARBOUR] (Davis' cousin's wife, twice removed) was born on 11 November 1907. She died on 5 October 1999, aged 91. She was buried in Mount Zion United Methodist Church, Johnston County.
"Graham" Hubbard Franks²⁴¹, aged 17, married Bettie Allene Franks [Barbour], aged 16, on 24 April 1924. They had two children:
Betty "Josephine" Carroll [Franks]¹⁷³ in 1926
"Donald" Ray Franks¹⁷⁵ in 1945
243. LUTHER WARREN FRANKS (Davis' cousin, twice removed) was born on 29 May 1921 to Leddie Bain Franks²⁸⁴ and Lillian "Lillie" Mary Franks [Godwin]²⁸⁵. Luther was a Building Contractor. He died on 27 May 1993, aged 71. He was buried in Holland's UMC, Ten-Ten Rd, Raleigh, North Carolina.
244. KATHLEEN FRANKS [HUMPHRIES] (Davis' cousin's wife, twice removed) was born on 16 October 1924.
Luther Warren Franks²⁴³ married Kathleen Franks [Humphries]. They had one son:
Michael Franks¹⁷⁶ in 1946
245. ANNIE LEE SHEPARD [FRANKS] (Davis' cousin, twice removed) was born on 25 May 1921 to Lewis Nathaniel "Snooks" Franks²⁸⁹ and Lydia Franks [Massey]²⁹⁰. She died on 4 November 2013, aged 92. She was buried in Montlawn Memorial Park, Raleigh, North Carolina.
246. GRAHAM DENNIS SHEPARD (Davis' cousin's husband, twice removed) was born on 23 July 1909. He died on 1 July 1983, aged 73. He was buried in Montlawn Memorial Park, Raleigh, North Carolina.
Graham Dennis Shepard married Annie Lee Shepard [Franks]²⁴⁵.
247. RUTH EMMA BAKER [FRANKS] (Davis' cousin, twice removed) was born in 1931 to Lewis Nathaniel "Snooks" Franks²⁸⁹ and Lydia Franks [Massey]²⁹⁰.
248. CLAUDE LEROY BAKER (Davis' cousin's husband, twice removed) was born on 20 July 1930. He died on 16 April 2001, aged 70.
Claude Leroy Baker married Ruth Emma Baker [Franks]²⁴⁷. They had one daughter:
Claudia Ruth Baker¹⁷⁹ in 1957
249. DEWITT CREECH WOODALL (Davis' second cousin, twice removed) was born on 28 September 1911 to John Franklin Woodall²⁹⁶ and Mattie Woodall [Creech]²⁹⁷. Dewitt was a Dentist. He died on 2 September 1975, aged 63. He was buried in Erwin Memorial Park.
250. LEAH ELIZABETH WOODALL [ALLEY] (Davis' second cousin's wife, twice removed) was born on 9 October 1914. She died on 12 July 2005, aged 90. She was buried in Erwin Memorial Park.
Dewitt Creech Woodall²⁴⁹ married Leah Elizabeth Woodall [Alley]. They had three children:
Elizabeth Ellen "Beth" Woodall¹⁸⁰ in 1941
Dewitt Creech "Woody" Woodall Jr.¹⁸¹ in 1943
Frank Alley "Al" Woodall¹⁸³ in 1945
251. JOHN ELMOND DUPREE SR. (Davis' second cousin, twice removed) was born on 19 November 1893 to William "Anguish" Dupree²⁹⁸ and Lugenia Elizabeth "Bettie" Dupree [Smith]²⁹⁹. He died on 30 September 1970, aged 76. He was buried in Lakeside Memorial Gardens, Harnett County, North Carolina.
252. MATTIE DUPREE [BRICKHOUSE] (Davis' second cousin's wife, twice removed) was born on 10 October 1900. She died on 25 May 1988, aged 87.
John Elmond Dupree Sr.²⁵¹ married Mattie Dupree [Brickhouse]. They had one son:
John Elmond "J.E." Dupree Jr.¹⁸⁵ in 1928
253. WILLIAM ANGUISH DUPREE SR. (Davis' second cousin, twice removed) was born on 18 September 1897 to William "Anguish" Dupree²⁹⁸ and Lugenia Elizabeth "Bettie" Dupree [Smith]²⁹⁹. He died on 17 February 1968, aged 70. He was buried in Montlawn Memorial Park, Raleigh, Wake Co, NC.

254. RUTH NAOLA DUPREE (Davis' second cousin's wife, twice removed) was born on 28 June 1905. She died on 2 March 2006, aged 100.
William Anguish Dupree Sr.²⁵³ married Ruth Naola Dupree. They had one son:
William Anguish "W.A." Dupree Jr.¹⁸⁷ in 1928
255. ALVIS HOLTON DUPREE (Davis' third cousin, twice removed) was born in 1911 to Henry Quinton Dupree³⁰⁰ and Lalah Florence Dupree [Gardner]³⁰¹. He died in 1967, aged about 56.
256. CLYDA DUPREE [YOUNG] (Davis' third cousin's wife, twice removed) was born in 1911. She died in 1985, aged about 74.
Alvis Holton Dupree²⁵⁵ married Clyda Dupree [Young]. They had four children:
Donna Kay Gaskin [Dupree]¹⁸⁹ in 1944
Ronald Holton Dupree¹⁹⁰ in 1945
Johnny Lee Dupree¹⁹¹ in 1947
Janet Doane Adams [Dupree]¹⁹² in 1951
257. FRANKLIN TAYLOR DUPREE JR. (Davis' third cousin, twice removed) was born on 8 October 1913 to Franklin Tell Dupree³⁰² and Elizabeth "Lizzie" Dupree [Wells]³⁰³. Franklin was a Federal Judge. He died on 17 December 1995, aged 82.
258. HERMAN KECK DUPREE (Davis' third cousin, twice removed) was born on 4 February 1919 to Franklin Tell Dupree³⁰² and Elizabeth "Lizzie" Dupree [Wells]³⁰³. Herman was a Geologist. He died in 1991, aged about 72, in Yellowstone Co, Montana.
259. HARRY CLAY DUPREE (Davis' third cousin, twice removed) was born on 4 November 1924 to Franklin Tell Dupree³⁰² and Elizabeth "Lizzie" Dupree [Wells]³⁰³. Harry was a Golf Pro. He died on 18 June 2004, aged 79, in Besty Johnson Memorial Hospital, Dunn, North Carolina. He was buried in Cremated.
260. BLANCHE WILLIAM DUPREE [OGBURN] (Davis' third cousin's wife, twice removed) was born on 30 November 1925. She died on 24 March 2012, aged 86.
Harry Clay Dupree²⁵⁹, aged 23, married Blanche William Dupree [Ogburn], aged 22, on 11 September 1948. They had three daughters:
Janet Lynn White [Dupree]¹⁹³ in 1949
Joan Elizabeth Blalock [Dupree]¹⁹⁴ in 1951
Beverly Clay Davis [Dupree]¹⁹⁵ in 1955

Generation of Great-Grandparents

261. EDWARD HALE WOODALL (Davis' great-grandfather) was born on 26 May 1861, in Johnston County, North Carolina, to Burt A Woodall³⁰⁴ and Eliza Woodall [Wellons]³⁰⁵, as shown in family tree 11. Edward was a Laborer. He died on 11 November 1937, aged 76. He was buried in Harnett Memorial Park, Lillington, North Carolina.
262. SARAH WOODALL [LEE] (Davis' great-grandmother) was born on 13 December 1871, in Johnston County, North Carolina, to Ransom Lee³⁰⁶ and Lucy E Lee [Rose]³⁰⁷, as shown in family tree 12. She died in 1945, aged about 73.
Edward Hale Woodall²⁶¹, aged 31, married Sarah Woodall [Lee], aged 20, on 3 October 1892. They had eight children:
Gilbert Chesley Woodall¹⁹⁶ in 1893
Hunter McGuire Woodall²⁰⁰ in 1896
Bettie Vandon Dean [Woodall]²⁰² in 1898
Clida Lee Woodall²⁰⁴ in 1901
Leigh Edward Woodall²⁰⁵ in 1903
Bert Albert Woodall²⁰⁷ in 1906
Willis Lester Woodall²⁰⁹ in 1910
Sallie Muriel Bradley [Woodall]²¹⁰ in 1913
This family is shown as family tree 7.
263. LEONARD LETHCO BRITT (Davis' great-grandfather) was born on 29 April 1865 to Joseph Leonard Britt³⁰⁸ and Edith Rebecca Britt [Young]³⁰⁹, as shown in family tree 13. He died on 6 August 1959, aged 94.
264. MARY FRANCIS BRITT [GUY] (Davis' great-grandmother) was born on 2 July 1866. She died on 3 November 1927, aged 61.
Leonard Lethco Britt²⁶³ married Mary Francis Britt [Guy]. They had six children:
Annie Sexton [Britt]²¹² in 1893
Ila Britt²¹³ in 1896
Alda Leland Woodall [Britt]¹⁹⁷ in 1898
Rado Utah Ennis [Britt]²¹⁴ in 1899
Broughton C Britt²¹⁵ in 1902
Ira Britt²¹⁶
This family is shown as family tree 8.

265. CHARLIE BENTON DUPREE (Davis' great-grandfather) was born on 26 December 1869 to James G Dupree³¹⁰ and Julia Ann Dupree [Adams]³¹¹, as shown in family tree 14. He died on 28 August 1930, aged 60. He was buried in Young Family Cemetery on County Line Rd, Harnett County, North Carolina.
266. MARTHA CAROLINE DUPREE [YOUNG] (Davis' great-grandmother) was born on 2 February 1868. She died (Cardiac Arrest) on 29 August 1945, aged 77. She was buried in Young Family Cemetery on County Line Rd, Harnett County, North Carolina.
- Charlie Benton Dupree²⁶⁵, aged about 22, married Martha Caroline Dupree [Young], aged about 24, about 1892. They had seven children:
- Ottis Alden Dupree²¹⁷ in 1892
 - Dorsey Benard Dupree²¹⁹ in 1894
 - Ila Ann Adams [Dupree]²²¹ in 1896
 - Cary Melvin Dupree²²³ in 1899
 - John Stuart Dupree¹⁹⁸ in 1902
 - Lois Creech [Dupree]²²⁵ about 1906
 - Charles Glenn Dupree²²⁷ in 1911
- This family is shown as family tree 9.*
267. ROBERT LARRY FRANKS (Davis' great-grandfather) was born on 28 February 1886, in McCullers, Wake County, North Carolina, to William Nathaniel "Nat" Franks³¹² and Lorenda Arinda "Lora" Franks [Perry]³¹³, as shown in family tree 15. He died on 29 July 1913, aged 27, in Wake County, Wendell, North Carolina. He was buried in Wentworth Bible Church Cemetery, Raleigh, North Carolina.
268. VIENNA JANNETTA FRANKS [MARSHBURN] (Davis' great-grandmother) was born on 27 January 1886 to Dr Berry Daniel Marshburn³¹⁵ and Susan Alice Marshburn [Parker]³¹⁶, as shown in family tree 16. She died on 20 December 1964, aged 78. She was buried in Young Family Cemetery on County Line Rd, Harnett County, North Carolina. Vienna married twice. She was married to Robert Larry Franks²⁶⁷ and William Adderson Watkins²⁶⁹.
- Robert Larry Franks²⁶⁷ married Vienna Jannetta Franks [Marshburn]. They had one daughter:
- Ruby Larry Dupree [Franks]¹⁹⁹ in 1913
- The following information is also recorded for this family. Widowed.
- This family is shown as family tree 10.*
269. WILLIAM ADDERSON WATKINS (Davis' great-grandmother's husband) was born on 6 April 1870. He died on 5 February 1939, aged 68. He was buried in Young Family Cemetery on County Line Rd, Harnett County, North Carolina. William Adderson Watkins married Vienna Jannetta Franks [Marshburn]²⁶⁸. They had four children:
- CPL Kenneth Lee Watkins²²⁹ in 1926
 - Daniel Parker "Danny" Watkins²³² in 1928
 - William Marshburn "Bill" Watkins²³⁵ in 1929
 - Ida Jones [Watkins]²³⁷
270. WILLIS L. WOODALL (Davis' great-great-uncle) was born in 1859 to Burt A Woodall³⁰⁴ and Eliza Woodall [Wellons]³⁰⁵, as shown in family tree 11. Willis was a Merchant, Banker. He resided (ADDR) at Smithfield, NC. He died on 25 July 1915, aged about 56.
271. CORNELIA WOODALL (Davis' great-great-aunt by marriage).
- Willis L. Woodall²⁷⁰ married Cornelia Woodall. They had two children:
- Kate Woodall²³⁹
 - Hubert C Woodall²⁴⁰
272. KATIE WOODALL (Davis' great-great-aunt) was born to Burt A Woodall³⁰⁴ and Eliza Woodall [Wellons]³⁰⁵, as shown in family tree 11.
273. EMMA WOODALL (Davis' great-great-aunt) was born to Burt A Woodall³⁰⁴ and Eliza Woodall [Wellons]³⁰⁵, as shown in family tree 11.
274. DAVID O. WOODALL (Davis' great-great-uncle) was born to Burt A Woodall³⁰⁴ and Eliza Woodall [Wellons]³⁰⁵, as shown in family tree 11.
275. TROY RANDOLPH BRITT (Davis' great-great-uncle) was born on 2 June 1855 to Joseph Leonard Britt³⁰⁸ and Edith Rebecca Britt [Young]³⁰⁹, as shown in family tree 13. He died on 28 January 1880, aged 24. He was buried in Britt Family Cemetery, Ten Ten Rd, Garner, North Carolina.
276. SUSANNA KINCAID BRITT (Davis' great-great-aunt) was born on 28 April 1859 to Joseph Leonard Britt³⁰⁸ and Edith Rebecca Britt [Young]³⁰⁹, as shown in family tree 13. She is no longer living.

277. ZEBBA BUNYAN BRITT (Davis' great-great-uncle) was born on 21 February 1861 to Joseph Leonard Britt³⁰⁸ and Edith Rebecca Britt [Young]³⁰⁹, as shown in family tree 13. He died in 1940, aged about 79.
278. MARTHA CHARLOTTE BRITT (Davis' great-great-aunt) was born on 14 November 1863 to Joseph Leonard Britt³⁰⁸ and Edith Rebecca Britt [Young]³⁰⁹, as shown in family tree 13. She is no longer living.
279. LUELLA ETTA BRITT (Davis' great-great-aunt) was born on 7 November 1869 to Joseph Leonard Britt³⁰⁸ and Edith Rebecca Britt [Young]³⁰⁹, as shown in family tree 13. She died on 17 April 1904, aged 34.
280. JOSEPH BURKE BRITT (Davis' great-great-uncle) was born on 26 October 1872 to Joseph Leonard Britt³⁰⁸ and Edith Rebecca Britt [Young]³⁰⁹, as shown in family tree 13. He died on 2 March 1952, aged 79. He was buried in Britt Family Cemetary, Ten Ten Rd, Garner, North Carolina.
281. MARY BRITT (Davis' great-great-aunt) was born to Joseph Leonard Britt³⁰⁸ and Edith Rebecca Britt [Young]³⁰⁹, as shown in family tree 13. She is no longer living.
282. SAMUEL "LATTIE" FRANKS (Davis' great-great-uncle) was born on 3 March 1884, in McCullers, Wake County, North Carolina, to William Nathaniel "Nat" Franks³¹² and Lorenda Arinda "Lora" Franks [Perry]³¹³, as shown in family tree 15. Samuel became known as "Lattie". He died on 18 December 1958, aged 74, in Wake County, North Carolina. He was buried in City Cemetary, Raleigh, North Carolina.
283. BETTIE PERRY FRANKS [SPEARS] (Davis' great-great-aunt by marriage) was born on 12 September 1884. She died on 28 February 1965, aged 80.
 Samuel "Lattie" Franks²⁸² married Bettie Perry Franks [Spears]. They had one son:
 "Graham" Hubbard Franks²⁴¹ in 1906
284. LEDDIE BAIN FRANKS (Davis' great-great-uncle) was born on 28 July 1887 to William Nathaniel "Nat" Franks³¹² and Lorenda Arinda "Lora" Franks [Perry]³¹³, as shown in family tree 15. He died on 18 October 1969, aged 82. He was buried in Mount Zion United Methodist Church, Johnston County, North Carolina.
285. LILLIAN "LILLIE" MARY FRANKS [GODWIN] (Davis' great-great-aunt by marriage) was born on 6 April 1899. Lillian became known as "Lillie". She died on 21 October 1989, aged 90. She was buried in Mount Zion United Methodist Church, Johnston County, North Carolina.
 Leddie Bain Franks²⁸⁴ married Lillian "Lillie" Mary Franks [Godwin]. They had one son:
 Luther Warren Franks²⁴³ in 1921
286. EMMA FOY HAYES [FRANKS] (Davis' great-great-aunt) was born on 9 June 1889, in McCullers, Wake County, North Carolina, to William Nathaniel "Nat" Franks³¹² and Lorenda Arinda "Lora" Franks [Perry]³¹³, as shown in family tree 15. She died on 19 April 1929, aged 39, in Robeson County, Marietta, North Carolina.
287. GROVER CARR FRANKS (Davis' great-great-uncle) was born on 13 March 1892, in Wake County, North Carolina, to William Nathaniel "Nat" Franks³¹² and Lorenda Arinda "Lora" Franks [Perry]³¹³, as shown in family tree 15. He died on 3 February 1963, aged 70, in Wake County, North Carolina. He was buried in Wentworth Bible Church Cemetary, Raleigh, North Carolina.
288. RUBY MABLE BECK [FRANKS] (Davis' great-great-aunt) was born on 5 October 1893 to William Nathaniel "Nat" Franks³¹² and Lorenda Arinda "Lora" Franks [Perry]³¹³, as shown in family tree 15. She died on 7 December 1928, aged 35. She was buried in Holland's UMC, Ten-Ten Rd, Raleigh, North Carolina.
289. LEWIS NATHANIEL "SNOOKS" FRANKS (Davis' great-great-uncle) was born on 27 April 1895 to William Nathaniel "Nat" Franks³¹² and Lorenda Arinda "Lora" Franks [Perry]³¹³, as shown in family tree 15. Lewis became known as "Snooks". He died on 29 May 1967, aged 72. He was buried in Holland's UMC, Ten-Ten Rd, Raleigh, North Carolina.
290. LYDIA FRANKS [MASSEY] (Davis' great-great-aunt by marriage) was born in 1898. She died in 1999, aged about 101. She was buried in Holland's UMC, Ten-Ten Rd, Raleigh, North Carolina.
 Lewis Nathaniel "Snooks" Franks²⁸⁹ married Lydia Franks [Massey]. They had two daughters:
 Annie Lee Shepard [Franks]²⁴⁵ in 1921
 Ruth Emma Baker [Franks]²⁴⁷ in 1931
291. JAMES LESLIE FRANKS (Davis' great-great-uncle) was born on 28 April 1897, in McCullers, Wake County, North Carolina, to William Nathaniel "Nat" Franks³¹² and Lorenda Arinda "Lora" Franks [Perry]³¹³, as shown in family tree 15. He died in 1901, aged about 4, in McCullers, Wake County, North Carolina. He was buried in Franklin Family Cemetary, Cary, North Carolina.

Note: Note 1.

292. LEE PERRY FRANKS (Davis' great-great-uncle) was born on 14 January 1898, in McCullers, Wake County, North Carolina, to William Nathaniel "Nat" Franks³¹² and Lorenda Arinda "Lora" Franks [Perry]³¹³, as shown in family tree 15. He died on 31 August 1968, aged 70, in Raleigh, North Carolina. He was buried in Wentworth Bible Church Cemetary, Raleigh, North Carolina.
293. LANCE H. FRANKS (Davis' great-great-uncle) was born on 26 July 1900, in McCullers, Wake County, North Carolina, to William Nathaniel "Nat" Franks³¹² and Lorenda Arinda "Lora" Franks [Perry]³¹³, as shown in family tree 15. He died on 5 July 1972, aged 71, in Caldwell County, Lenoir, North Carolina. He was buried in Littlejohn Methodist Church Cemetery, Caldwell County, Gamewell, North Carolina.
294. CHRISTOPHER CLINTON FRANKS (Davis' great-great-uncle) was born on 15 July 1905, in McCullers, Wake County, North Carolina, to William Nathaniel "Nat" Franks³¹² and Lorenda Arinda "Lora" Franks [Perry]³¹³, as shown in family tree 15. He died on 19 August 1984, aged 79, in Raleigh, North Carolina. He was buried in Wentworth Bible Church Cemetary, Raleigh, North Carolina.
295. ALPHA BYON FRANKS (Davis' great-great-uncle) was born on 14 February 1909, in McCullers, Wake County, North Carolina, to William Nathaniel "Nat" Franks³¹² and Lorenda Arinda "Lora" Franks [Perry]³¹³, as shown in family tree 15. He died on 6 October 1993, aged 84, in Wake County, North Carolina. He was buried in Montlawn Memorial Park, Raleigh, North Carolina.
296. JOHN FRANKLIN WOODALL (Davis' cousin, three times removed) was born on 7 August 1878 to John G Woodall³¹⁷ and Emily Woodall [Eldridge]³¹⁸. He died on 2 September 1963, aged 85.
297. MATTIE WOODALL [CREECH] (Davis' cousin's wife, three times removed) was born in 1890. She is no longer living.
John Franklin Woodall²⁹⁶ married Mattie Woodall [Creech]. They had one son:
Dewitt Creech Woodall²⁴⁹ in 1911
298. WILLIAM "ANGUISH" DUPREE (Davis' cousin, three times removed) was born on 3 February 1860 to William H Dupree³¹⁹ and Eugenia "Jane" Dupree [Stancil]³²⁰. William became known as "Anguish". He died on 24 May 1921, aged 61. He was buried in W. A. Dupree Family Cemetery, Johnston County, North Carolina.
299. LUGENIA ELIZABETH "BETTIE" DUPREE [SMITH] (Davis' cousin's wife, three times removed) was born on 2 December 1863. Lugenia became known as "Bettie". She died on 8 June 1940, aged 76. She was buried in W. A. Dupree Family Cemetery, Johnston County, North Carolina.
William "Anguish" Dupree²⁹⁸ married Lugenia Elizabeth "Bettie" Dupree [Smith]. They had two sons:
John Elmond Dupree Sr.²⁵¹ in 1893
William Anguish Dupree Sr.²⁵³ in 1897
300. HENRY QUINTON DUPREE (Davis' second cousin, three times removed) was born in 1883 to Joseph Dupree³²⁴ and Eliza Jane Dupree [Adams]³²⁵. He died in 1966, aged about 83.
301. LALAH FLORENCE DUPREE [GARDNER] (Davis' second cousin's wife, three times removed) was born in 1880. She died in 1960, aged about 80.
Henry Quinton Dupree³⁰⁰ married Lalah Florence Dupree [Gardner]. They had one son:
Alvis Holton Dupree²⁵⁵ in 1911
302. FRANKLIN TELL DUPREE (Davis' second cousin, three times removed) was born on 4 April 1886 to Benjamine Franklin Dupree³²⁶ and Fannie Telfer Dupree [Love]³²⁷. He died on 15 November 1968, aged 82. He was buried in Montlawn Memorial Park, Raleigh, Wake Co, NC.
303. ELIZABETH "LIZZIE" DUPREE [WELLS] (Davis' second cousin's wife, three times removed) was born on 15 September 1889. Elizabeth became known as "Lizzie". She died on 17 August 1976, aged 86.
Franklin Tell Dupree³⁰² married Elizabeth "Lizzie" Dupree [Wells]. They had three sons:
Franklin Taylor Dupree Jr.²⁵⁷ in 1913
Herman Keck Dupree²⁵⁸ in 1919
Harry Clay Dupree²⁵⁹ in 1924

Generation of Great-Great-Grandparents

304. BURT A WOODALL (Davis' great-great-grandfather) was born in 1829, in Johnston County, North Carolina, to James Gower Woodall³²⁸ and Sarah "Sally" Woodall [Barber]³²⁹, as shown in family tree 17. Burt was a Farming. He died in 1894, aged about 65. He was buried in Riverside Cemetery Smithfield, North Carolina.
305. ELIZA WOODALL [WELLONS] (Davis' great-great-grandmother) was born in 1830, in Johnston County, North Carolina. She is no longer living.
Burt A Woodall³⁰⁴, aged about 25, married Eliza Woodall [Wellons], aged about 24, on 2 November 1854. They had five children:
Willis L. Woodall²⁷⁰ in 1859
Edward Hale Woodall²⁶¹ in 1861
Katie Woodall²⁷²
Emma Woodall²⁷³
David O. Woodall²⁷⁴
This family is shown as family tree 11.
306. RANSOM LEE (Davis' great-great-grandfather) was born on 29 August 1820, in Johnston County, North Carolina, to Henry "Harry" Lee³³⁰ and Sally Lee [Coats]³³¹, as shown in family tree 18. He died in July 1882, aged 61, in Johnston County, North Carolina.
307. LUCY E LEE [ROSE] (Davis' great-great-grandmother) was born on 22 February 1834. She died on 18 May 1908, aged 74.
Ransom Lee³⁰⁶ married Lucy E Lee [Rose]. They had one daughter:
Sarah Woodall [Lee]²⁶² in 1871
This family is shown as family tree 12.
308. JOSEPH LEONARD BRITT (Davis' great-great-grandfather) was born on 27 May 1837, in Wake County, North Carolina, to Hardy Britt³³² and Charlotte Britt [Penny]³³³, as shown in family tree 19. He died on 20 May 1874, aged 36.
309. EDITH REBECCA BRITT [YOUNG] (Davis' great-great-grandmother) was born on 12 May 1835 to Young Ezekiel Young Sr.³³⁴ and Patsy Young [Tomlinson]³³⁵, as shown within family tree 8. She died on 14 August 1910, aged 75.
Joseph Leonard Britt³⁰⁸, aged 17, married Edith Rebecca Britt [Young], aged 19, on 9 August 1854. They had eight children:
Troy Randolph Britt²⁷⁵ in 1855
Susanna Kincaid Britt²⁷⁶ in 1859
Zeba Bunyan Britt²⁷⁷ in 1861
Martha Charlotte Britt²⁷⁸ in 1863
Leonard Lethco Britt²⁶³ in 1865
Luella Etta Britt²⁷⁹ in 1869
Joseph Burke Britt²⁸⁰ in 1872
Mary Britt²⁸¹
This family is shown as family tree 13.
310. JAMES G DUPREE (Davis' great-great-grandfather) was born on 24 May 1839 to Thomas Jefferson Dupree³³⁶ and Allie Oliver Dupree [Gregory]³³⁷, as shown in family tree 20. He died on 20 January 1912, aged 72. He was buried in Family Cemetery, SR 1531 Pleasant Grove Township, Johnston County, North Carolina.
311. JULIA ANN DUPREE [ADAMS] (Davis' great-great-grandmother) was born on 22 October 1836 to Joseph Adams³³⁸ and Talitha Adams [Johnson]³³⁹, as shown within family tree 14. She died on 11 February 1890, aged 53. She was buried in Family Cemetery, SR 1531 Pleasant Grove Township, Johnston County, North Carolina.
James G Dupree³¹⁰ married Julia Ann Dupree [Adams]. They had one son:
Charlie Benton Dupree²⁶⁵ in 1869
This family is shown as family tree 14.
312. WILLIAM NATHANIEL "NAT" FRANKS (Davis' great-great-grandfather) was born on 25 December 1858, in Wake County, North Carolina, to James "Jim" David Franks³⁴⁰ and Emma Gasten Franks [Jones]³⁴¹, as shown in family tree 21. William became known as "Nat". He died on 1 July 1929, aged 70. He was buried in Franks Family Cemetery, McCullers, Wake County, North Carolina.
William married twice. He was married to Lorenda Arinda "Lora" Franks [Perry]³¹³ and Martha Franks [Mitchell]³¹⁴.
313. LORENDA ARINDA "LORA" FRANKS [PERRY] (Davis' great-great-grandmother) was born on 12 August 1864, in Wake County, North Carolina, to Robert Sidney Perry³⁴² and Julia A. Perry [Speight]³⁴³, as shown within family tree 15. Lorenda became known as "Lora". She died on 1 June 1912, aged 47, in McCullers, Wake County, North Carolina. She was buried in Franks Family Cemetery, McCullers, Wake County, North Carolina.

William Nathaniel "Nat" Franks³¹² married Lorenda Arinda "Lora" Franks [Perry]. They had twelve children:

- Samuel "Lattie" Franks²⁸² in 1884
- Robert Larry Franks²⁶⁷ in 1886
- Leddie Bain Franks²⁸⁴ in 1887
- Emma Foy Hayes [Franks]²⁸⁶ in 1889
- Grover Carr Franks²⁸⁷ in 1892
- Ruby Mable Beck [Franks]²⁸⁸ in 1893
- Lewis Nathaniel "Snooks" Franks²⁸⁹ in 1895
- James Leslie Franks²⁹¹ in 1897
- Lee Perry Franks²⁹² in 1898
- Lance H. Franks²⁹³ in 1900
- Christopher Clinton Franks²⁹⁴ in 1905
- Alpha Byon Franks²⁹⁵ in 1909

The following information is also recorded for this family. Separation; Widowed.

This family is shown as family tree 15.

314. MARTHA FRANKS [MITCHELL] (Davis' great-great-grandfather's wife). She is no longer living.
William Nathaniel "Nat" Franks³¹², aged about 55, married Martha Franks [Mitchell] in 1914.
315. DR BERRY DANIEL MARSHBURN (Davis' great-great-grandfather) was born on 16 August 1854 to William Marshburn³⁴⁶ and Susan Marshburn [Ellis]³⁴⁷, as shown in family tree 22. Dr was a Medical Doctor degree from Austria. He died on 30 March 1934, aged 79. He was buried in Johnston County, Selma, North Carolina.
316. SUSAN ALICE MARSHBURN [PARKER] (Davis' great-great-grandmother) was born on 3 November 1852, in North Carolina. She died on 6 January 1933, aged 80. She was buried in Johnston County, Selma, North Carolina.
Dr Berry Daniel Marshburn³¹⁵, aged about 18, married Susan Alice Marshburn [Parker], aged about 20, about 1873. They had one daughter:
Vienna Jannetta Franks [Marshburn]²⁶⁸ in 1886
This family is shown as family tree 16.
317. JOHN G WOODALL (Davis' great-great-great-uncle) was born in 1825 to James Gower Woodall³²⁸ and Sarah "Sally" Woodall [Barber]³²⁹, as shown in family tree 17. John was a Farmer. He died in 1895, aged about 70.
318. EMILY WOODALL [ELDRIDGE] (Davis' great-great-great-aunt by marriage) was born in 1836. She is no longer living.
John G Woodall³¹⁷ married Emily Woodall [Eldridge]. They had one son:
John Franklin Woodall²⁹⁶ in 1878
319. WILLIAM H DUPREE (Davis' great-great-great-uncle) was born in 1836 to Thomas Jefferson Dupree³³⁶ and Allie Oliver Dupree [Gregory]³³⁷, as shown in family tree 20. He died on 5 January 1863, aged about 26.
320. EUGENIA "JANE" DUPREE [STANCIL] (Davis' great-great-great-aunt by marriage) was born in 1837. Eugenia became known as "Jane". She died on 18 October 1917, aged about 80.
Note: *Jane was married to 2 different William H Duprees. Her first died during the Civil War and was the son of Thomas & Allie Dupree and her second was her first husband's first cousin, the son of James and Grace Dupree.*
William H Dupree³¹⁹ married Eugenia "Jane" Dupree [Stancil]. They had one son:
William "Anguish" Dupree²⁹⁸ in 1860
321. JOHN BENTON DUPREE (Davis' great-great-great-uncle) was born in 1854 to Thomas Jefferson Dupree³³⁶ and Allie Oliver Dupree [Gregory]³³⁷, as shown in family tree 20. He died in 1924, aged about 70.
322. MOSLEY R H FRANKS (Davis' great-great-great-uncle) was born on 26 June 1865 to James "Jim" David Franks³⁴⁰ and Emma Gasten Franks [Jones]³⁴¹, as shown in family tree 21. He died on 12 February 1870, aged 4.
323. MARY ELIZABETH FRANKS (Davis' great-great-great-aunt) was born on 14 May 1871 to James "Jim" David Franks³⁴⁰ and Emma Gasten Franks [Jones]³⁴¹, as shown in family tree 21. She died on 6 October 1892, aged 21.
324. JOSEPH DUPREE (Davis' cousin, four times removed) was born in 1838 to James Dupree³⁴⁸ and Grace Dupree [Blalock]³⁴⁹. He died in 1905, aged about 67.
325. ELIZA JANE DUPREE [ADAMS] (Davis' cousin's wife, four times removed) was born in 1839. She died in 1898, aged about 59.
Joseph Dupree³²⁴ married Eliza Jane Dupree [Adams]. They had one son:
Henry Quinton Dupree³⁰⁰ in 1883
326. BENJAMINE FRANKLIN DUPREE (Davis' cousin, four times removed) was born on 28 October 1861 to Nathaniel

Dupree³⁵⁰ and Elizabeth Dupree [Turlington]³⁵¹. He died on 2 May 1941, aged 79. He was buried in Angier Primitive Baptist Church Cemetery, Angier, Harnett Co, NC.

327. FANNIE TELFER DUPREE [LOVE] (Davis' cousin's wife, four times removed) was born on 27 March 1863. She died on 31 August 1956, aged 93. She was buried in Angier Primitive Baptist Church Cemetery, Angier, Harnett Co, NC.

Benjamin Franklin Dupree³²⁶ married Fannie Telfer Dupree [Love]. They had one son:

Franklin Tell Dupree³⁰² in 1886

Generation of Great-Great-Great-Grandparents

328. JAMES GOWER WOODALL (Davis' great-great-great-grandfather) was born on 29 May 1800 to Jacob B. Woodall³⁵² and Lucy Phereby Woodall [Gower]³⁵³, as shown in family tree 23. He died in 1865, aged about 65, in Johnston County, North Carolina.

329. SARAH "SALLY" WOODALL [BARBER] (Davis' great-great-great-grandmother) was born in 1802, in North Carolina. Sarah became known as "Sally". She is no longer living.

James Gower Woodall³²⁸, aged 21, married Sarah "Sally" Woodall [Barber], aged about 19, on 10 August 1821. They had two sons:

John G Woodall³¹⁷ in 1825

Burt A Woodall³⁰⁴ in 1829

This family is shown as family tree 17.

330. HENRY "HARRY" LEE (Davis' great-great-great-grandfather) was born in 1781, in Johnston County, North Carolina, to Lemuel Samuel "Lom" Lee³⁵⁴ and Ann Lee [Rains]³⁵⁵, as shown in family tree 24. Henry became known as "Harry". He died in 1860, aged about 79, in Arkansas.

331. SALLY LEE [COATS] (Davis' great-great-great-grandmother) was born about 1783. She is no longer living.

Henry "Harry" Lee³³⁰, aged about 29, married Sally Lee [Coats], aged about 27, about 1810. They had one son:

Ransom Lee³⁰⁶ in 1820

This family is shown as family tree 18.

332. HARDY BRITT (Davis' great-great-great-grandfather) was born in 1800, in Wake County, North Carolina, to Joseph Britt Jr.³⁵⁶ and Nancy Britt [Stephens]³⁵⁷, as shown in family tree 25. He died in 1878, aged about 78, in Wake County, North Carolina.

333. CHARLOTTE BRITT [PENNY] (Davis' great-great-great-grandmother) was born in 1800, in Wake County, North Carolina. She died in 1870, aged about 70.

Hardy Britt³³², aged about 22, married Charlotte Britt [Penny], aged about 22, on 21 January 1823 in Wake County, North Carolina. They had one son:

Joseph Leonard Britt³⁰⁸ in 1837

This family is shown as family tree 19.

334. YOUNG EZEKIEL YOUNG SR. (Davis' great-great-great-grandfather). He is no longer living.

335. PATSY YOUNG [TOMLINSON] (Davis' great-great-great-grandmother).

Young Ezekiel Young Sr.³³⁴ married Patsy Young [Tomlinson]. They had one daughter:

Edith Rebecca Britt [Young]³⁰⁹ in 1835

This family is shown within family tree 8.

336. THOMAS JEFFERSON DUPREE (Davis' great-great-great-grandfather) was born about 1809 to Henry Dupree³⁵⁸ and Kizzie Dupree [Young]³⁵⁹, as shown in family tree 26. Thomas was a Blacksmith. He died about 1876, aged about 67.

337. ALLIE OLIVER DUPREE [GREGORY] (Davis' great-great-great-grandmother) was born in February 1810. She is no longer living.

Thomas Jefferson Dupree³³⁶ married Allie Oliver Dupree [Gregory]. They had three sons:

William H Dupree³¹⁹ in 1836

James G Dupree³¹⁰ in 1839

John Benton Dupree³²¹ in 1854

This family is shown as family tree 20.

338. JOSEPH ADAMS (Davis' great-great-great-grandfather) was born on 8 May 1803 to John Adams³⁶⁰ and Delilah Adams [Green]³⁶¹, as shown within family tree 14. He died on 12 May 1877, aged 74.

339. TALITHA ADAMS [JOHNSON] (Davis' great-great-great-grandmother) was born on 3 March 1804. She died on 14 May 1876, aged 72.

Joseph Adams³³⁸ married Talitha Adams [Johnson]. They had one daughter:

Julia Ann Dupree [Adams]³¹¹ in 1836

This family is shown within family tree 14.

340. JAMES "JIM" DAVID FRANKS (Davis' great-great-great-grandfather) was born on 25 December 1834 to Anthony Franks³⁶² and Anna Franks [Hunter]³⁶³, as shown in family tree 27. James became known as "Jim". James was a Farmer. He died (Stroke of Paralysis) on 11 July 1904, aged 69. He was buried in Franklin Family Cemetary, Cary, North Carolina.
Note: *Note 1.*
341. EMMA GASTEN FRANKS [JONES] (Davis' great-great-great-grandmother) was born on 7 March 1838 to Austin Jones³⁶⁴ and Martha Ann Jones [Lane]³⁶⁵, as shown in family tree 28. She died on 9 August 1918, aged 80. She was buried in Catawba Springs Christian Church Cemetery, Ten-Ten Rd, Apex, North Carolina.
James "Jim" David Franks³⁴⁰ married Emma Gasten Franks [Jones]. They had three children:
William Nathaniel "Nat" Franks³¹² in 1858
Mosley R H Franks³²² in 1865
Mary Elizabeth Franks³²³ in 1871
This family is shown as family tree 21.
342. ROBERT SIDNEY PERRY (Davis' great-great-great-grandfather) was born on 27 August 1829, in Wake County, North Carolina, to John W Perry³⁶⁶ and Nancy Ann Perry [Baker]³⁶⁷, as shown within family tree 15. He died on 14 September 1913, aged 84, in Wake County, North Carolina. He was buried in Oakwood Cemetary, Raleigh, North Carolina.
Robert married three times. He was married to Julia A. Perry [Speight]³⁴³, Mitty Ann Perry [Horton]³⁴⁴ and Jane Ellen Perry [Watkins]³⁴⁵.
343. JULIA A. PERRY [SPEIGHT] (Davis' great-great-great-grandmother) was born on 15 July 1831, in Wake County, North Carolina. She died on 11 July 1868, aged 36, in Wake County, North Carolina. She was buried in Oakwood Cemetary, Raleigh, North Carolina.
Robert Sidney Perry³⁴², aged 25, married Julia A. Perry [Speight], aged 23, on 13 December 1854. They had one daughter:
Lorenda Arinda "Lora" Franks [Perry]³¹³ in 1864
The following information is also recorded for this family. Widowed.
This family is shown within family tree 15.
344. MITTY ANN PERRY [HORTON] (Davis' step-great-great-great-grandmother). She is no longer living.
Robert Sidney Perry³⁴², aged 39, married Mitty Ann Perry [Horton] on 30 December 1868.
345. JANE ELLEN PERRY [WATKINS] (Davis' great-great-great-grandfather's wife) was born on 17 July 1842, in Wake County, North Carolina. She died on 15 September 1912, aged 70, in Wake County, North Carolina. She was buried in Oakwood Cemetary, Raleigh, North Carolina.
Robert Sidney Perry³⁴² married Jane Ellen Perry [Watkins].
346. WILLIAM MARSHBURN (Davis' great-great-great-grandfather) was born about 1803 to Pvt Daniel Mashburn³⁶⁸ and Delphia Mashburn [Warren]³⁶⁹, as shown in family tree 29. He is no longer living.
347. SUSAN MARSHBURN [ELLIS] (Davis' great-great-great-grandmother) was born about 1814 to Berry Ellis³⁷⁰, as shown within family tree 16. She is no longer living.
William Marshburn³⁴⁶, aged about 32, married Susan Marshburn [Ellis], aged about 21, on 26 August 1835. They had one son:
Dr Berry Daniel Marshburn³¹⁵ in 1854
This family is shown as family tree 22.
348. JAMES DUPREE (Davis' great-great-great-great-uncle) was born in 1807 to Henry Dupree³⁵⁸ and Kizzie Dupree [Young]³⁵⁹, as shown in family tree 26. He is no longer living.
349. GRACE DUPREE [BLALOCK] (Davis' great-great-great-great-aunt by marriage) was born in 1816. She is no longer living.
James Dupree³⁴⁸ married Grace Dupree [Blalock]. They had one son:
Joseph Dupree³²⁴ in 1838
350. NATHANIEL DUPREE (Davis' great-great-great-great-uncle) was born in April 1816 to Henry Dupree³⁵⁸ and Kizzie Dupree [Young]³⁵⁹, as shown in family tree 26. He died in 1906, aged about 90. He was buried in Dupree Family Cemetery, McGee Crossroads, Johnston Co, NC.
351. ELIZABETH DUPREE [TURLINGTON] (Davis' great-great-great-great-aunt by marriage) was born on 2 May 1824. She died on 17 May 1908, aged 84. She was buried in Dupree Family Cemetery, McGee Crossroads, Johnston Co, NC.
Nathaniel Dupree³⁵⁰ married Elizabeth Dupree [Turlington]. They had one son:
Benjamine Franklin Dupree³²⁶ in 1861

Generation of Four-Times-Great-Grandparents

352. JACOB B. WOODALL (Davis' four-times-great-grandfather) was born in 1767, in Johnston County, North Carolina, to Jacob Woodall³⁷¹ and Agnes Woodall [Hicks]³⁷², as shown in family tree 30. He died in 1849, aged about 82, in Johnston County, North Carolina.
353. LUCY PHEREBY WOODALL [GOWER] (Davis' four-times-great-grandmother) was born in 1770, in North Carolina. She died in 1851, aged about 81, in Johnston County, North Carolina.
Jacob B. Woodall³⁵², aged about 22, married Lucy Phereby Woodall [Gower], aged about 19, on 16 December 1789. They had one son:
James Gower Woodall³²⁸ in 1800
This family is shown as family tree 23.
354. LEMUEL SAMUEL "LOM" LEE (Davis' four-times-great-grandfather) was born on 5 March 1753, in North Carolina, to Edward G Lee³⁷³ and Mary Lee [Allen]³⁷⁴, as shown in family tree 31. Lemuel became known as "Lom". He died on 15 September 1843, aged 90, in Johnston County, North Carolina.
355. ANN LEE [RAINS] (Davis' four-times-great-grandmother) was born in 1755, in Johnston County, North Carolina. She died in 1821, aged about 66, in Johnston County, North Carolina.
Lemuel Samuel "Lom" Lee³⁵⁴, aged about 22, married Ann Lee [Rains], aged about 20, in 1775. They had one son:
Henry "Harry" Lee³³⁰ in 1781
This family is shown as family tree 24.
356. JOSEPH BRITT JR. (Davis' four-times-great-grandfather) was born in 1774, in Wake County, North Carolina, to Joseph Britt³⁷⁵ and Ms. Britt³⁷⁶, as shown in family tree 32. He died in 1839, aged about 65, in Southampton County, Virginia.
357. NANCY BRITT [STEPHENS] (Davis' four-times-great-grandmother) was born in 1765, in Duplin County, North Carolina. She is no longer living.
Joseph Britt Jr.³⁵⁶, aged about 16, married Nancy Britt [Stephens], aged about 25, on 16 November 1790 in Wake County, North Carolina. They had one son:
Hardy Britt³³² in 1800
This family is shown as family tree 25.
358. HENRY DUPREE (Davis' four-times-great-grandfather) was born in 1784, in Greensville, Southampton County, Virginia, to Haley Dupree II³⁷⁸ and Elizabeth Bettie Dupree [Clark]³⁷⁹, as shown in family tree 33. He died about 1850, aged about 66.
359. KIZZIE DUPREE [YOUNG] (Davis' four-times-great-grandmother) was born about 1777, in Virginia. She is no longer living.
Henry Dupree³⁵⁸ married Kizzie Dupree [Young]. They had three sons:
James Dupree³⁴⁸ in 1807
Thomas Jefferson Dupree³³⁶ about 1809
Nathaniel Dupree³⁵⁰ in 1816
This family is shown as family tree 26.
360. JOHN ADAMS (Davis' four-times-great-grandfather) was born on 19 May 1767, in Cumberlin County, North Carolina. He died in 1848, aged about 81, in Cumberlin County, North Carolina.
361. DELILAH ADAMS [GREEN] (Davis' four-times-great-grandmother) was born about 1774. She died about 1850, aged about 76.
John Adams³⁶⁰ married Delilah Adams [Green]. They had one son:
Joseph Adams³³⁸ in 1803
This family is shown within family tree 14.
362. ANTHONY FRANKS (Davis' four-times-great-grandfather) was born in 1803 to Lewis Henry Franks³⁸⁰ and Sarah Franks [Freeman]³⁸¹, as shown in family tree 34. He died in 1871, aged about 68, in Wake County, North Carolina.
363. ANNA FRANKS [HUNTER] (Davis' four-times-great-grandmother) was born in 1805. She died in 1871, aged about 66.
Anthony Franks³⁶² married Anna Franks [Hunter]. They had one son:
James "Jim" David Franks³⁴⁰ in 1834
This family is shown as family tree 27.
364. AUSTIN JONES (Davis' four-times-great-grandfather) was born in 1797 to Robert Jones³⁸² and Peggy Jones³⁸³, as shown within family tree 21. He died in 1860, aged about 63.
365. MARTHA ANN JONES [LANE] (Davis' four-times-great-grandmother) was born in 1812 to Nathaniel M. Lane³⁸⁴ and Elizabeth Lane [Smith]³⁸⁵, as shown in family tree 35. She died in 1880, aged about 68.
Austin Jones³⁶⁴ married Martha Ann Jones [Lane]. They had one daughter:
Emma Gasten Franks [Jones]³⁴¹ in 1838
This family is shown as family tree 28.

366. JOHN W PERRY (Davis' four-times-great-grandfather) was born on 15 November 1780, in Chatham County, North Carolina. He died in 1853, aged about 72.
367. NANCY ANN PERRY [BAKER] (Davis' four-times-great-grandmother) was born in 1784, in Franklin County, North Carolina. She died in 1850, aged about 66, in Wake County, North Carolina.
John W Perry³⁶⁶ married Nancy Ann Perry [Baker]. They had one son:
Robert Sidney Perry³⁴² in 1829
This family is shown within family tree 15.
368. PVT DANIEL MASHBURN (Davis' four-times-great-grandfather) was born in 1757 to Matthew Mashburn³⁸⁶ and Sarah Mashburn³⁸⁷, as shown in family tree 36. He died on 31 January 1848, aged about 90, in Wake County, North Carolina.
369. DELPHIA MASHBURN [WARREN] (Davis' four-times-great-grandmother) was born about 1773, in Northampton County, North Carolina, to George Warren³⁸⁸, as shown within family tree 22. She died after 1861, when older than 88, in Probably Cumberland County, North Carolina.
Pvt Daniel Mashburn³⁶⁸ married Delphia Mashburn [Warren] '1792 or 1793'. They had one son:
William Marshburn³⁴⁶ about 1803
This family is shown as family tree 29.
370. BERRY ELLIS (Davis' four-times-great-grandfather). He is no longer living.
Berry fathered one daughter:
Susan Marshburn [Ellis]³⁴⁷ about 1814
This family is shown within family tree 16.

Generation of Five-Times-Great-Grandparents

371. JACOB WOODALL (Davis' five-times-great-grandfather) was born in 1740, in Goochland County, Virginia, to John Issac Woodall³⁹⁴ and Judith Woodall [Sampson]³⁹⁵, as shown in family tree 37. He died in 1808, aged about 68, in Johnston County, North Carolina.
Note: *Military Service: American Revolution*
<p>TRAVELS: Jacob and Agnes were living in Goochland County, Virginia when their first 2 children were born in 1763 and 1765. The St. James Northam Parish Register (The Douglas Register), Goochland County Virginia was a register kept by the ministers of the Angelican Church, the official church of the Colony of Virginia. The Reverend William Douglas kept records of all births, marriages, etc. This register has the earliest known information about Jacob Woodall. In 1770 they were living in Granville County, North Carolina where they were listed in the will of Samuel Hicks. They appear on the Granville County census between the years of 1784 to 1787. Records in Granville and Johnston County, North Carolina indicate that Jacob and Agnes had 3 more children. In 1790 the census of the United States shows Jacob had moved to the Johnston County, North Carolina Newbern District. The 1786 census shows 2 males between 21 and 60; 2 males under 21 and over 60; 3 females. In August of 1787 Jacob and his son James sold some of the land he and Agnes inherited from Samuel Hicks. Agnes relinquished her right of dower in the land and it was sold to Lewis Parham. The 1790 census of Newbern District, Johnston County, North Carolina shows 1 male over 16, 2 males under 16 and 2 females. Jacob purchased land in Johnston County, North Carolina from Matthew Mathis in November of 1790 and the purchase was proved in court by oath of Absolom Woodall.
372. AGNES WOODALL [HICKS] (Davis' five-times-great-grandmother) was born in 1750, in Goochland, Goochland County, Virginia. She died in 1773, aged about 23, in North Carolina.
Jacob Woodall³⁷¹, aged about 23, married Agnes Woodall [Hicks], aged about 13, in 1763. They had one son:
Jacob B. Woodall³⁵² in 1767
This family is shown as family tree 30.
373. EDWARD G LEE (Davis' five-times-great-grandfather) was born in 1725, in Virginia, to Capt. John Esquire Lee³⁹⁶ and Mary Lee [Bryan]³⁹⁷, as shown in family tree 38. He died in 1775, aged about 50, in North Carolina.
374. MARY LEE [ALLEN] (Davis' five-times-great-grandmother) was born in 1726, in Virginia. She died on 20 October 1800, aged about 74.
Edward G Lee³⁷³, aged about 20, married Mary Lee [Allen], aged about 19, in 1745. They had one son:
Lemuel Samuel "Lom" Lee³⁵⁴ in 1753
This family is shown as family tree 31.
375. JOSEPH BRITT (Davis' five-times-great-grandfather) was born on 16 June 1731, in Canterbury, Windham County, Connecticut, to John Britt Jr.³⁹⁸ and Freelove Britt [Fenno]³⁹⁹, as shown in family tree 39. He died in 1799, aged about 68, in Isle of Wight County, Virginia.
Joseph married twice. He was married to Ms. Britt³⁷⁶ and Olive Britt [Davis]³⁷⁷.

Note: *BIOGRAPHY: At a very young age Joseph is thought to have been given to his grandparents, John Brett and Susannah Brasey, to rear in their home in Bertie Co, NC. His presumed parents were married less than a year. Because they married 6 months after Joseph's birth, the young age of both John Jr and Freeloove, the fact the marriage only lasted a few months and they were both known to live in the area all point to the parents as being John Jr and Freeloove.*

The Family Search LDS site lists a birth for Joseph Britt b. 16 June 1731 in Canterbury, Windham Co, Ct. The only name listed other than Joseph Britt is a "Family Relative, Lottie, C.R. Carter".

The spelling for "Britt" was different than the surname spelling by the New England Brett families. John Britt Jr converted his surname to "Britt" at a very early age either to differentiate him from his father, John Brett or resentment because his father left the family when John Jr was only 4 years old. John Jr's father left him out of his WILL with the statement that he thought his son was deceased so he left 100. acre estate to his grandson, Joseph, whom he had reared in lieu of a portion to his son, John Jr. He did include his daughter, Hannah, from his Boston family in his WILL.

The location of Joseph's death has not been proved, although several facts point to his death in Isle of Wight Co, Va. The estate was closed out in Wake Co, NC in Feb 1801 court action, but the site of the WILL Probate has not been verified.

376. MS. BRITT (Davis' five-times-great-grandmother) was born about 1740, in Virginia or North Carolina. She is no longer living. Joseph Britt³⁷⁵ married Ms. Britt. They had one son:

Joseph Britt Jr.³⁵⁶ in 1774

This family is shown as family tree 32.

377. OLIVE BRITT [DAVIS] (Davis' five-times-great-grandfather's wife) was born about 1735, in Virginia or Massachusetts. She is no longer living.

Note: *Joseph Britt married Olive Swanson on 26 Jan 1788 in Wake Co, NC. Olive Swanson had previously been married to Joseph's neighbor, Richard Swanson. Richard Swanson served as Bondsman for Joseph's wedding according to the Wake Co, NC Genealogy Booklet: "Early Britts of Wake Co". Richard is believed to have gone to Lincoln Co, NC after Joseph and Olive married. Richard Swanson's name did not appear on the 1790 or 1800 Federal Census. Richard was born abt 1725 in Brunswick Co, Va and Olive (Davis?) was born abt 1735. They had 2 sons born in Edgecombe Co, NC: William b. 1754 and John b. 14 April 1761. Both sons married in Wake Co, NC and John later moved to Wilkes Co, NC.*

Joseph Britt³⁷⁵, aged 56, married Olive Britt [Davis], aged about 52, on 26 January 1788 in Wake County, North Carolina.

378. HALEY DUPREE II (Davis' five-times-great-grandfather) was born in 1759 to Haley Dupree⁴⁰² and Susannah Elizabeth Dupree [Garris]⁴⁰³, as shown in family tree 40. He died in Wake County, North Carolina.

379. ELIZABETH BETTIE DUPREE [CLARK] (Davis' five-times-great-grandmother). She is no longer living.

Haley Dupree II³⁷⁸ married Elizabeth Bettie Dupree [Clark]. They had one son:

Henry Dupree³⁵⁸ in 1784

This family is shown as family tree 33.

380. LEWIS HENRY FRANKS (Davis' five-times-great-grandfather) was born in 1777, in Wake County, North Carolina, to Anthony Franks⁴⁰⁴ and Martha Franks [Cook]⁴⁰⁵, as shown in family tree 41. He died in 1850, aged about 73, in Wake County, North Carolina.

381. SARAH FRANKS [FREEMAN] (Davis' five-times-great-grandmother) was born in 1780, in Wake County, North Carolina. She died in 1850, aged about 70.

Lewis Henry Franks³⁸⁰ married Sarah Franks [Freeman] in Wake County, North Carolina. They had one son:

Anthony Franks³⁶² in 1803

This family is shown as family tree 34.

382. ROBERT JONES (Davis' five-times-great-grandfather). He is no longer living.

383. PEGGY JONES (Davis' five-times-great-grandmother). She is no longer living.

Robert Jones³⁸² married Peggy Jones. They had one son:

Austin Jones³⁶⁴ in 1797

This family is shown within family tree 21.

384. NATHANIAL M. LANE (Davis' five-times-great-grandfather) was born on 11 November 1770, in Wake County, North Carolina, to James Lane⁴⁰⁶ and Lydia Lane [Speight]⁴⁰⁷, as shown in family tree 42. He died on 5 July 1852, aged 81, in Wake County, North Carolina.

385. ELIZABETH LANE [SMITH] (Davis' five-times-great-grandmother) was born on 31 January 1779, in Wake County, North Carolina. She died on 25 September 1815, aged 36.

Nathaniel M. Lane³⁸⁴ married Elizabeth Lane [Smith]. They had one daughter:
 Martha Ann Jones [Lane]³⁶⁵ in 1812
This family is shown as family tree 35.

386. MATTHEW MASHBURN (Davis' five-times-great-grandfather) was born in 1703, in Nansemond, Virginia, to Edward Mashborne Mashburn Jr.⁴⁰⁸ and Elizabeth Mashburn [Rhodes]⁴⁰⁹, as shown within family tree 29. He died on 1 July 1760, aged about 57, in Northampton County, North Carolina.
387. SARAH MASHBURN (Davis' five-times-great-grandmother) was born in 1703, in Northampton County, North Carolina. She died in Northampton County, North Carolina.
 Matthew Mashburn³⁸⁶, aged about 20, married Sarah Mashburn, aged about 20, in 1723. They had one son:
 Pvt Daniel Mashburn³⁶⁸ in 1757
This family is shown as family tree 36.
388. GEORGE WARREN (Davis' five-times-great-grandfather). He is no longer living.
 George fathered one daughter:
 Delphia Mashburn [Warren]³⁶⁹ about 1773
This family is shown within family tree 22.
389. JOHN BRITT (Davis' five-times-great-great-uncle) was born on 11 July 1756, in Newbury, Essex County, Massachusetts, to John Britt Jr.³⁹⁸ and Mary Britt [Moody]⁴⁰⁰. He died on 13 September 1830, aged 74, in Newburyport, Essex County, Massachusetts.
390. JAMES BRITT (Davis' five-times-great-great-uncle) was born on 9 July 1758, in Goochland County, Virginia, to John Britt Jr.³⁹⁸ and Winifred Britt [Connolly]⁴⁰¹. He died in Goochland County, Virginia.
391. DANIEL BRITT (Davis' five-times-great-great-uncle) was born on 28 September 1760, in Goochland County, Virginia, to John Britt Jr.³⁹⁸ and Winifred Britt [Connolly]⁴⁰¹. He died in 1840, aged about 79, in Marion, Marion County, South Carolina.
392. MILLY BRITT (Davis' five-times-great-great-aunt) was born on 19 July 1763, in Goochland County, Virginia, to John Britt Jr.³⁹⁸ and Winifred Britt [Connolly]⁴⁰¹. She is no longer living.
393. MOLLY BRITT (Davis' five-times-great-great-aunt) was born on 10 January 1766, in Goochland County, Virginia, to John Britt Jr.³⁹⁸ and Winifred Britt [Connolly]⁴⁰¹. She is no longer living.

Generation of Six-Times-Great-Grandparents

394. JOHN ISSAC WOODALL (Davis' six-times-great-grandfather) was born in 1710, in Goochland, Virginia, to John Woodall⁴²¹ and Sarah Woodall [Stanley]⁴²², as shown in family tree 43. He died in 1809, aged about 99, in Franklin, Virginia.
395. JUDITH WOODALL [SAMPSON] (Davis' six-times-great-grandmother). She is no longer living.
 John Issac Woodall³⁹⁴, aged about 21, married Judith Woodall [Sampson] in 1731 in Goochland County, Virginia. They had one son:
 Jacob Woodall³⁷¹ in 1740
This family is shown as family tree 37.
396. CAPT. JOHN ESQUIRE LEE (Davis' six-times-great-grandfather) was born in 1689, in New Kent, Virginia, to Richard Henry Lee⁴²³ and Mary Lee [Young]⁴²⁴, as shown in family tree 44. He died on 4 December 1766, aged about 77, in North Carolina.
397. MARY LEE [BRYAN] (Davis' six-times-great-grandmother) was born in 1690. She died in 1792, aged about 102.
 Capt. John Esquire Lee³⁹⁶ married Mary Lee [Bryan]. They had one son:
 Edward G Lee³⁷³ in 1725
This family is shown as family tree 38.
398. JOHN BRITT JR. (Davis' six-times-great-grandfather) was born on 22 July 1713, in Boston, Suffolk County, Massachusetts, to John Brett⁴²⁵ and Ann Brett [Barnsdale (Barnsdell)]⁴²⁶, as shown in family tree 45. He died on 12 December 1797, aged 84, in Newburyport, Essex County, Massachusetts.
 John married three times. He was married to Freelove Britt [Fenno]³⁹⁹, Mary Britt [Moody]⁴⁰⁰ and Winifred Britt [Connolly]⁴⁰¹.
399. FREELOVE BRITT [FENNO] (Davis' six-times-great-grandmother) was born on 1 February 1715, in Dorchester, Norfolk County, Massachusetts. She died in 1736, aged about 21.

John Britt Jr.³⁹⁸, aged 18, married Freelope Britt [Fenno], aged 16, on 20 January 1732. They had one son:

Joseph Britt³⁷⁵ in 1731

This family is shown as family tree 39.

400. MARY BRITT [MOODY] (Davis' step-six-times-great-grandmother) was born in 1728, in Newburyport, Essex County, Massachusetts. She is no longer living.

John Britt Jr.³⁹⁸, aged 34, married Mary Britt [Moody], aged about 19, on 10 September 1747. They had one son:

John Britt³⁸⁹ in 1756

401. WINIFRED BRITT [CONNOLLY] (Davis' step-six-times-great-grandmother) was born about 1735, in Prince William County, Virginia. She died in 1770, aged about 35, in Goochland County, Virginia.

John Britt Jr.³⁹⁸, aged 43, married Winifred Britt [Connolly], aged about 21, on 9 October 1756 in Goochland County, Virginia. They had four children:

James Britt³⁹⁰ in 1758

Daniel Britt³⁹¹ in 1760

Milly Britt³⁹² in 1763

Molly Britt³⁹³ in 1766

402. HALEY DUPREE (Davis' six-times-great-grandfather) was born in 1727, in Pitt County, North Carolina, to Loys "Louis" Dupree⁴²⁷ and Larance Lara Dupree [Ellerbee]⁴²⁸, as shown in family tree 46. He died in 1807, aged about 80.

403. SUSANNAH ELIZABETH DUPREE [GARRIS] (Davis' six-times-great-grandmother).

Haley Dupree⁴⁰² married Susannah Elizabeth Dupree [Garris] in Greenville, Virginia. They had one son:

Haley Dupree II³⁷⁸ in 1759

This family is shown as family tree 40.

404. ANTHONY FRANKS (Davis' six-times-great-grandfather) was born in 1750 to Jacob Miller Franks⁴²⁹ and Mary Ann Franks [Ashley]⁴³⁰, as shown in family tree 47. He died in 1820, aged about 70, in Wake County, North Carolina.

405. MARTHA FRANKS [COOK] (Davis' six-times-great-grandmother) was born in 1749, in Province of, North Carolina. She died in 1827, aged about 78, in Wake County, North Carolina.

Anthony Franks⁴⁰⁴ married Martha Franks [Cook]. They had one son:

Lewis Henry Franks³⁸⁰ in 1777

This family is shown as family tree 41.

406. JAMES LANE (Davis' six-times-great-grandfather) was born in 1739, in Halifax County, North Carolina. He died on 6 January 1805, aged about 65, in Wake County, North Carolina.

407. LYDIA LANE [SPEIGHT] (Davis' six-times-great-grandmother) was born on 24 April 1743, in Edgecomb County, North Carolina, to Captain William Spaight⁴³¹ and Abigail Spaight [Westropp]⁴³², as shown within family tree 42. She died in 1805, aged about 62, in Wake County, North Carolina.

James Lane⁴⁰⁶, aged about 21, married Lydia Lane [Speight], aged about 17, in 1760 in Halifax County, North Carolina.

They had one son:

Nathaniel M. Lane³⁸⁴ in 1770

This family is shown as family tree 42.

408. EDWARD MASHBORNE MASHBURN JR. (Davis' six-times-great-grandfather) was born on 27 May 1676, in St Giles Parrish, London, England, to Edward Mashborne Mashburn Sr.⁴³³ and Sarah Mashburn [Sindery]⁴³⁴, as shown in family tree 48. Edward was a School Master. He died on 22 April 1739, aged 62, in Onslow County, North Carolina.

The following information is also recorded for Edward. Religion: May 27 1676 St. Giles Parish, London, England.

Edward married twice. He was married to Elizabeth Mashburn [Rhodes]⁴⁰⁹ and Elizabeth Mashburn [Nash]⁴¹⁰.

409. ELIZABETH MASHBURN [RHODES] (Davis' six-times-great-grandmother) was born in 1675, in North Carolina. She is no longer living.

Edward Mashborne Mashburn Jr.⁴⁰⁸, aged about 26, married Elizabeth Mashburn [Rhodes], aged about 27, about 1702.

They had one son:

Matthew Mashburn³⁸⁶ in 1703

This family is shown within family tree 29.

410. ELIZABETH MASHBURN [NASH] (Davis' six-times-great-grandfather's wife). She died in 1712 in London, England.

Edward Mashborne Mashburn Jr.⁴⁰⁸ married Elizabeth Mashburn [Nash].

411. WILLIAM WOODALL SR. (Davis' six-times-great-great-uncle) was born in 1709 to John Woodall⁴²¹ and Sarah Woodall [Stanley]⁴²², as shown in family tree 43. He died in August 1797, aged about 88.

412. SARAH PRIOR [WOODALL] (Davis' six-times-great-great-aunt) was born in 1717 to John Woodall⁴²¹ and Sarah Woodall [Stanley]⁴²², as shown in family tree 43. She is no longer living.

413. HANNAH BRITT (Davis' six-times-great-great-aunt) was born on 9 May 1711, in Boston, Suffolk County, Massachusetts, to John Brett⁴²⁵ and Ann Brett [Barnsdale (Barnsdell)]⁴²⁶, as shown in family tree 45. She died in Newbury, Essex County, Massachusetts.
414. WILLIAM BRETT BRITT (Davis' six-times-great-great-uncle) was born on 20 January 1719, in Boston, Suffolk County, Massachusetts, to John Brett⁴²⁵ and Ann Brett [Barnsdale (Barnsdell)]⁴²⁶, as shown in family tree 45. He died on 4 January 1787, aged 67, in Goochland County, Virginia.
415. KIT CARSON MASHBURN (Davis' six-times-great-great-uncle) was born to Edward Mashborne Mashburn Sr.⁴³³. He is no longer living.
416. RUBY MASHBURN (Davis' six-times-great-great-aunt) was born to Edward Mashborne Mashburn Sr.⁴³³ and Allie Mashburn [Stephens]⁴³⁵. She is no longer living.
417. ETTA MASHBURN (Davis' six-times-great-great-aunt) was born to Edward Mashborne Mashburn Sr.⁴³³ and Allie Mashburn [Stephens]⁴³⁵.
418. SAMUEL MASHBURN (Davis' six-times-great-great-uncle) was born on 9 January 1675 to Edward Mashborne Mashburn Sr.⁴³³ and Sarah Mashburn [Sindery]⁴³⁴, as shown in family tree 48. He is no longer living.
419. SARAH MASHBURN (Davis' six-times-great-great-aunt) was born on 25 August 1680 to Edward Mashborne Mashburn Sr.⁴³³ and Sarah Mashburn [Sindery]⁴³⁴, as shown in family tree 48. She is no longer living.
420. MATTHEW MASHBURN (Davis' six-times-great-great-uncle) was born in 1683, in London, Middlesex, England, to Edward Mashborne Mashburn Sr.⁴³³ and Sarah Mashburn [Sindery]⁴³⁴, as shown in family tree 48. He is no longer living.

Generation of Seven-Times-Great-Grandparents

421. JOHN WOODALL (Davis' seven-times-great-grandfather) was born in 1678, in Henrico County, Virginia, to Dr. John William Woodall⁴³⁹ and Sarah Woodall [Henchpole]⁴⁴⁰, as shown in family tree 49. He died on 19 March 1750, aged about 71, in Goochland, Virginia.
422. SARAH WOODALL [STANLEY] (Davis' seven-times-great-grandmother) was born in 1680, in Virginia. She died in 1747, aged about 67, in Goochland, Goochland County, Virginia.
 John Woodall⁴²¹ married Sarah Woodall [Stanley] in Anderson, South Carolina. They had three children:
 William Woodall Sr.⁴¹¹ in 1709
 John Issac Woodall³⁹⁴ in 1710
 Sarah Prior [Woodall]⁴¹² in 1717
This family is shown as family tree 43.
423. RICHARD HENRY LEE (Davis' seven-times-great-grandfather) was born in 1670, in England, to William Lee⁴⁴¹ and Alice Lee [Felton]⁴⁴², as shown in family tree 50. He died in 1726, aged about 56, in King Queen (King and Queen), Virginia.
424. MARY LEE [YOUNG] (Davis' seven-times-great-grandmother) was born in 1670, in England. She died in Virginia.
 Richard Henry Lee⁴²³ married Mary Lee [Young]. They had one son:
 Capt. John Esquire Lee³⁹⁶ in 1689
This family is shown as family tree 44.
425. JOHN BRETT (Davis' seven-times-great-grandfather) was born on 26 February 1669, in Rattlesden, Suffolk County, England, to John Brett⁴⁴³ and Elizabeth Brett [Waters]⁴⁴⁴, as shown in family tree 51. He died on 23 May 1738, aged 69, in (will Filed) in Bertie Co, North Carolina.
 Note: *BIOGRAPHY: John Brett was born in Rattlesden, England in 1667. He was the first of 4 children born to John Brett and Elizabeth Waters. John and Elizabeth were married in Hurstmonceux, Sussex, England in 1778. It is thought that marriage was dissolved in 1685 as that was the last record of John Brett's annual trips from England to Va. The 1685 trip made by John Brett was on the Ship Stephen, which left London 20 August 1685. Another ship, the Globe left London port 12 August 1685 bound for Maryland. This ship also had a John Brett passenger. The John Brett passenger on the Globe is thought to be the son of John Brett who was a passenger on the ship Stephen which left London port 8 days later bound for Va. Young John Brett is presumed to move to Bridgewater, Ma to live with his "uncle" William Jr Brett who had lived in Rattlesden, England as a brother to young John's father until he was 10 years at which time he went back to his biological father, William Brett SR. William Jr Brett married Elizabeth Carey in 1781 and was living in Bridgewater at the time. John's father was living by himself in Isle of Wight, Va and was unable to take care care of the 16 year old son. He did not remarry until 1699.*
 <p>There is no record of young John's itinerary between his arrival in America and his marriage to Anne Barnsdale in

Boston, Ma in 1710, although it must be presumed he was an apprentice in the maritime industry.

<p>John Brett was a maritime captain sailing from USA to England. There are several references in Peter Coldham's book: Complete Book of Emigrants 1700-1750, describing the dates of his sailing starting 15-19 September 1711, ship: CATHERINE, Boston brigantine; sailing from Plymouth for Boston. 1-26 March 1713, ship: AURORA, sailing from Plymouth for New England; aboard a representative of John Brett & Co. (John may have owned the shipping line). 27-29 November 1727 John Brett captained the ship, PRINCESS AMELIA, bound from Weymouth, England for Virginia. 5 March 1737 John Brett captained the ship, ELIZABETH, bound from Weymouth, England to Virginia. This may have been John's last trip as he died in 1738 based on the date of his WILL.

<p>The ship destinations listed above support the assumption made that John Brett left Boston between 1713-1727 for Virginia where he married Susannah Bressey, his father's widow, abt 1718 and died abt 1738 in Bertie Co, NC.

426. ANN BRETT [BARNSDALE (BARNSDELL)] (Davis' seven-times-great-grandmother) was born on 1 February 1688, in Boston, Suffolk County, Massachusetts. She is no longer living.
John Brett⁴²⁵, aged 41, married Ann Brett [Barnsdale (Barnsdell)], aged 22, on 29 June 1710 in Boston, Suffolk County, Massachusetts. They had three children:
Hannah Britt⁴¹³ in 1711
John Britt Jr.³⁹⁸ in 1713
William Brett Britt⁴¹⁴ in 1719
This family is shown as family tree 45.
427. LOYS "LOUIS" DUPREE (Davis' seven-times-great-grandfather) was born in 1683, in La Rochelle, Manche, Brasse-Normandie, France, to Josias "Joseph" Crancie Dupree⁴⁴⁷ and Mynetta "Mary" Denizot Dupree [Lamoreaux]⁴⁴⁸, as shown in family tree 52. Loys became known as "Louis". He died on 12 July 1748, aged about 65, in Brunswick, Virginia.
428. LARANCE LARA DUPREE [ELLERBEE] (Davis' seven-times-great-grandmother) was born in 1686, in Lunenburg, Virginia. She died in 1734, aged about 48, in Brunswick, Virginia.
Loys "Louis" Dupree⁴²⁷ married Larance Lara Dupree [Ellerbee] in Lunenburg, Virginia. They had one son:
Haley Dupree⁴⁰² in 1727
This family is shown as family tree 46.
429. JACOB MILLER FRANKS (Davis' seven-times-great-grandfather) was born in 1721, in Craven County, North Carolina, to John Martin Franck⁴⁴⁹ and Sevil Civil Franck [Timmerman]⁴⁵⁰, as shown in family tree 53. He died in 1794, aged about 73, in Kentucky. He was buried in Mt. Zion, Grant, Kentucky.
430. MARY ANN FRANKS [ASHLEY] (Davis' seven-times-great-grandmother) was born in 1725, in Province of, North Carolina. She died in 1789, aged about 64, in Virginia.
Jacob Miller Franks⁴²⁹ married Mary Ann Franks [Ashley]. They had one son:
Anthony Franks⁴⁰⁴ in 1750
This family is shown as family tree 47.
431. CAPTAIN WILLIAM SPAIGHT (Davis' seven-times-great-grandfather) was born in 1714, in Isle of Wright, Nanesmond, Virginia, to John Thomas Speight⁴⁵¹ and Elizabeth Spaight [Powell]⁴⁵², as shown within family tree 42. He died in May 1774, aged about 59, in Halifax, Virginia.
432. ABIGAIL SPAIGHT [WESTROPP] (Davis' seven-times-great-grandmother) was born in 1724, in Johnston County, North Carolina. She died on 17 January 1781, aged about 56.
Captain William Spaight⁴³¹ married Abigail Spaight [Westropp]. They had one daughter:
Lydia Lane [Speight]⁴⁰⁷ in 1743
This family is shown within family tree 42.
433. EDWARD MASHBORNE MASHBURN SR. (Davis' seven-times-great-grandfather) was born about 1655, in St Giles Parrish, London, England. He died on 12 October 1712, aged about 57, in St. Giles Parrish, London, England.
Edward married three times; including Sarah Mashburn [Sindery]⁴³⁴ and Allie Mashburn [Stephens]⁴³⁵.
Edward fathered one son:
Kit Carson Mashburn⁴¹⁵
This family is shown as family tree 48.
434. SARAH MASHBURN [SINDERY] (Davis' seven-times-great-grandmother) was born in 1656, in St Giles Parrish, London, England. She died in 1685, aged about 29.
Edward Mashborne Mashburn Sr.⁴³³, aged about 21, married Sarah Mashburn [Sindery], aged about 20, on 16 August 1676 in St. Dunston, East London, England. They had four children:
Samuel Mashburn⁴¹⁸ in 1675
Edward Mashborne Mashburn Jr.⁴⁰⁸ in 1676
Sarah Mashburn⁴¹⁹ in 1680
Matthew Mashburn⁴²⁰ in 1683
This family is shown as family tree 48.

435. ALLIE MASHBURN [STEPHENS] (Davis' seven-times-great-grandfather's wife). She is no longer living.
Edward Mashborne Mashburn Sr.⁴³³ married Allie Mashburn [Stephens]. They had two daughters:
Ruby Mashburn⁴¹⁶
Etta Mashburn⁴¹⁷
436. NATHANIEL BRETT (Davis' seven-times-great-great-uncle) was born on 23 June 1672, in Rattlesden, Suffolk County, England, to John Brett⁴⁴³ and Elizabeth Brett [Waters]⁴⁴⁴, as shown in family tree 51. He is no longer living.
437. MARY BRETT (Davis' seven-times-great-great-aunt) was born on 25 March 1677, in Rattlesden, Suffolk County, England, to John Brett⁴⁴³ and Elizabeth Brett [Waters]⁴⁴⁴, as shown in family tree 51. She is no longer living.
438. JAMES BRETT (Davis' seven-times-great-great-uncle) was born on 5 October 1679, in Rattlesden, Suffolk County, England, to John Brett⁴⁴³ and Elizabeth Brett [Waters]⁴⁴⁴, as shown in family tree 51. He is no longer living.

Generation of Eight-Times-Great-Grandparents

439. DR. JOHN WILLIAM WOODALL (Davis' eight-times-great-grandfather) was born on 22 July 1627, in St Benet Fink, Hemingbrough Yorkshire, England, to Surgeon General John Woodall⁴⁵⁷ and Sara Woodall [Staelie]⁴⁵⁸, as shown in family tree 54. He died in 1680, aged about 52, in Westminster, London, England.
440. SARAH WOODALL [HENCHPOLE] (Davis' eight-times-great-grandmother) was born in 1630. She is no longer living.
Dr. John William Woodall⁴³⁹ married Sarah Woodall [Henchpole]. They had one son:
John Woodall⁴²¹ in 1678
This family is shown as family tree 49.
441. WILLIAM LEE (Davis' eight-times-great-grandfather) was born in 1651, in Northcumberland, Virginia, to Colonel Richard Henry Lee⁴⁵⁹ and Ann Lee [Constable]⁴⁶⁰, as shown in family tree 55. He died on 25 May 1709, aged about 57, in Suit, King Queen, Virginia.
442. ALICE LEE [FELTON] (Davis' eight-times-great-grandmother) was born in 1655, in Virginia. She died in 1703, aged about 48, in Virginia.
William Lee⁴⁴¹ married Alice Lee [Felton]. They had one son:
Richard Henry Lee⁴²³ in 1670
This family is shown as family tree 50.
443. JOHN BRETT (Davis' eight-times-great-grandfather) was born on 7 March 1635, in Rattlesden, Suffolk County, England, to Edmund Brett⁴⁶¹ and Elizabeth Susan Brett [Gosling]⁴⁶², as shown in family tree 56. He died about 1718, aged about 83, in Isle of Wight County, Virginia.
John married three times. He was married to Ann Brett [Woodward]⁴⁴⁵, Elizabeth Brett [Waters]⁴⁴⁴ and Susannah Brett [Bressie]⁴⁴⁶.
444. ELIZABETH BRETT [WATERS] (Davis' eight-times-great-grandmother) was born in 1657, in Boston, Suffolk County, Massachusetts. She is no longer living.
John Brett⁴⁴³, aged about 43, married Elizabeth Brett [Waters], aged about 21, in 1678 in Hurstmonceux, Sussex, England.
They had four children:
John Brett⁴²⁵ in 1669
Nathaniel Brett⁴³⁶ in 1672
Mary Brett⁴³⁷ in 1677
James Brett⁴³⁸ in 1679
This family is shown as family tree 51.
445. ANN BRETT [WOODWARD] (Davis' eight-times-great-grandfather's previous wife) was born about 1631, in Worcestershire, England. She is no longer living.
John Brett⁴⁴³, aged about 26, married Ann Brett [Woodward], aged about 30, in 1661 in Rattlesden, Suffolk County, England.
446. SUSANNAH BRETT [BRESSIE] (Davis' step-eight-times-great-grandmother) was born about 1680, in Isle of Wight County, Virginia. She died about 1740, aged about 60.
John Brett⁴⁴³, aged about 64, married Susannah Brett [Bressie], aged about 19, in 1699 in Isle of Wight County, Virginia.
447. JOSIAS "JOSEPH" CRANCIE DUPREE (Davis' eight-times-great-grandfather) was born in 1654, in Haute-Saone (Haute-Saône), France, to Barthelemy DuPre⁴⁶⁴ and Matilda DuPree [Robin]⁴⁶⁵, as shown in family tree 57. Josias became known as "Joseph". He is no longer living.

448. MYNETTA "MARY" DENIZOT DUPREE [LAMOREAUX] (Davis' eight-times-great-grandmother) was born in 1656, in Cannes, Gard, Languedoc-Roussillon, France. Mynetta became known as "Mary". She died in September 1690, aged about 34, in France.
 Josias "Joseph" Crancie Dupree⁴⁴⁷ married Mynetta "Mary" Denizot Dupree [Lamoreaux] in Languedoc-Roussillon, Gard, France. They had one son:
 Loys "Louis" Dupree⁴²⁷ in 1683
This family is shown as family tree 52.
449. JOHN MARTIN FRANCK (Davis' eight-times-great-grandfather) was born about 1 June 1675, in Salsburg, Bavarian, Palatinate Section, Germany, to August Hermann Francke⁴⁶⁶ and Anna Magdalena Francke [von Wurmb]⁴⁶⁷, as shown in family tree 58. He died on 3 November 1744, aged about 69, in Craven County, North Carolina.
450. SEVIL CIVIL FRANCK [TIMMERMAN] (Davis' eight-times-great-grandmother) was born in 1694, in Bayern, Germany. She died in 1752, aged about 58, in Jones County, North Carolina.
 John Martin Franck⁴⁴⁹ married Sevil Civil Franck [Timmerman]. They had one son:
 Jacob Miller Franks⁴²⁹ in 1721
This family is shown as family tree 53.
451. JOHN THOMAS SPEIGHT (Davis' eight-times-great-grandfather) was born in 1687, in Isle of Wright County, near South Quay, Virginia. He died in 1738, aged about 51, in Suffolk County, Virginia.
452. ELIZABETH SPAIGHT [POWELL] (Davis' eight-times-great-grandmother) was born in 1689, in Kingsland, Herefordshire, England. She died in 1739, aged about 50, in Isle of Wright, Virginia.
 The following information is also recorded for Elizabeth. Baptist on 30 August 1691, aged about 2, in Kingsland, Herefordshire, England.
 John Thomas Speight⁴⁵¹ married Elizabeth Spaight [Powell]. They had one son:
 Captain William Spaight⁴³¹ in 1714
This family is shown within family tree 42.
453. SUSAN BRETT BRITT (Davis' eight-times-great-great-aunt) was born on 24 November 1633, in Rattlesden, Suffolk County, England, to Edmund Brett⁴⁶¹ and Elizabeth Susan Brett [Gosling]⁴⁶², as shown in family tree 56. She is no longer living.
454. ELIZABETH BRETT BRITT (Davis' eight-times-great-great-aunt) was born on 7 March 1635, in Rattlesden, Suffolk County, England, to Edmund Brett⁴⁶¹ and Elizabeth Susan Brett [Gosling]⁴⁶², as shown in family tree 56. She is no longer living.
455. WILLIAM BRETT JR. (Davis' eight-times-great-great-uncle) was born in 1635, in Kent, Sussex County, England, to Edmund Brett⁴⁶¹ and Elizabeth Susan Brett [Gosling]⁴⁶², as shown in family tree 56. He died in 1713, aged about 78, in Bridgewater, Plymouth County, Massachusetts.
 Note: *William Jr Brett's father was William Brett Sr, b. 1618, Kent, England; mother was Lydia Margret Leonard, b. abt 1615, Kent, England. It is thought that he was given to Edmund and Susan Brett in Rattlesden, Suffolk Co, England to rear as they were apparently unprepared for a family. He was returned to William Brett Sr in Bridgewater, Plymouth Co, Ma. Abt 1645. This was about the time that Edmund Brett's son, John Brett, also left Rattlesden, England to move to Isle of Wight, Va. This data is based on Mormon LDS and other records. In 1645 a William Brett was documented in Philby's Ship Passenger Immigration Volume 1 as making the trip to New England from London. This trip was apparently made to reunite William Jr Brett with his biological father, William Brett Sr in Bridgewater, Ma.*
456. WILLIAM BRETT (Davis' eight-times-great-great-uncle) was born on 8 January 1637, in Rattlesden, Suffolk County, England, to Edmund Brett⁴⁶¹ and Elizabeth Susan Brett [Gosling]⁴⁶², as shown in family tree 56. He died in 1711, aged about 74, in Nansemond County, Virginia.

Generation of Nine-Times-Great-Grandparents

457. SURGEON GENERAL JOHN WOODALL (Davis' nine-times-great-grandfather) was born in 1569, in London, England, to Richard Woodall⁴⁷⁰ and Mary Woodall [Ithell]⁴⁷¹, as shown in family tree 59. He died on 28 August 1643, aged about 74, in London, England.

Note: *From Wikipedia, the free encyclopedia John Woodall, George Glover, published 1639*

John Woodall (1570–1643) was an English military surgeon, Paracelsian chemist, businessman, linguist and diplomat. He made a fortune through the stocking of medical chests for the East India Company and later the armed forces of England. He is remembered for his authorship of The Surgeon's Mate which was the standard text to advise ships surgeons on medical treatments while at sea and contains an advanced view on the treatment of scurvy.

Woodall was the son of Richard Woodall of Warwick, and was apprenticed around the age of 16 or 17 to a London barber

surgeon. He did not finish his apprenticeship but gained experience from the age of nineteen in 1589 as a surgeon with Lord Willoughby's regiment on its expedition to support the Protestant Henry IV of France and King of Navarre in his campaign against the Catholic League of Normandy. He returned in 1590.

Woodall is known to have then lived and worked as a surgeon in Polonia and Stade, a Hanseatic port near Hamburg, whilst there he was occasionally employed as a German interpreter by visiting English ambassadors.

In 1599 he was admitted to the Barber-Surgeons Company of London as a freeman but continued to live mainly on the continent in Holland, until 1603 when he took up residence in Wood Street, London. He was able to offer treatment to victims of the plague epidemic. At unspecified times in his life he contracted bubonic plague and survived, writing of this, "...for I had it twice, namely at two severall Plague times in my Groyne."

In 1604 James I of England sent an embassy, led by Sir Thomas Smith, Governor of the East India Company, to Poland and possibly to Russia. Woodall was included for his knowledge of the region and command of the languages. The association with Smith was a fruitful one for Woodall, for in 1612 Sir Thomas appointed Woodall to serve as Surgeon General to the East India Company. His duties were described as follows:

"The Said Chiurgion and the Deputy shall have a place of lodging in the Yard, where one of them shall give Attendance every working day from morning until night, to cure any person or persons who may be hurt in the Service of this Company and the like in all their Ships, riding at Anchor at Deptford and Blackwell, and at Erith, where he shall also keepe a Deputy with his chest furnished, to remaine there continually until all the said ships have sayled and appointing fit and able Surgeons and Surgeon's Mates for their ships and services, as also the fitting and furnishing of their Chests with medicines and other appurtenances thereto."

Woodall's career then progressed rapidly with election as a surgeon at St. Bartholomew's Hospital in 1616 where he was a colleague of Sir William Harvey. He was promoted to examiner in the Barber-Surgeons Company in 1626, to warden in 1627 and then master in 1633.

He suffered a setback, however, in 1625 when he served a writ on Sir Thomas Merry, a servant of the King who owed Woodall money. For his effrontery to royal privilege, the Lord Steward had Woodall imprisoned. He was briefly released to supervise surgeon's chests for the next fleet at the request of the East India Company, but was then jailed once more. He was only freed when he issued a contrite apology.

The following year of 1626 the Privy Council decided to pay the Barber-Surgeons Company fixed allowances to furnish medical chests for both the army and navy, and Woodall was appointed to supervise this scheme in addition to his long-standing similar commitment to the East India Company.

He was eventually dismissed by the East India Company in 1635 for financial reasons, but retained a monopoly on supplying the Company's medical chests until he died in 1643, aged 73.

458. SARA WOODALL [STAUELIE] (Davis' nine-times-great-grandmother) was born in 1570. She died in September 1641, aged about 71.

Surgeon General John Woodall⁴⁵⁷ married Sara Woodall [Staelie]. They had one son:

Dr. John William Woodall⁴³⁹ in 1627

This family is shown as family tree 54.

459. COLONEL RICHARD HENRY LEE (Davis' nine-times-great-grandfather) was born on 22 March 1618, in Coton Hall, Nordley Regis, Shropshire, England, to John Lee Sr.⁴⁷² and Jane Lee [Hancock]⁴⁷³, as shown in family tree 60. He died on 1 March 1664, aged 45, in Dividing Creek, Northumberland, Virginia.

460. ANN LEE [CONSTABLE] (Davis' nine-times-great-grandmother) was born in 1622, in London, Middlesex, England. She died on 6 October 1706, aged about 84, in Northumberland, Virginia.

Colonel Richard Henry Lee⁴⁵⁹ married Ann Lee [Constable]. They had one son:

William Lee⁴⁴¹ in 1651

This family is shown as family tree 55.

461. EDMUND BRETT (Davis' nine-times-great-grandfather) was born about 1603, in Bury St. Edmunds, Suffolk County, England, to Thomas Brett Britt⁴⁷⁴ and Ursula Britt [Coward]⁴⁷⁵, as shown in family tree 61. He died in 1674, aged about 71, in Suffolk County, England.

Edmund married twice. He was married to Elizabeth Susan Brett [Gosling]⁴⁶² and Elizabeth Brett [Lowe]⁴⁶³.

462. ELIZABETH SUSAN BRETT [GOSLING] (Davis' nine-times-great-grandmother) was born in 1603. She died on 16 September 1671, aged about 68.

Edmund Brett⁴⁶¹ married Elizabeth Susan Brett [Gosling]. They had five children:

Susan Brett Britt⁴⁵³ in 1633

Elizabeth Brett Britt⁴⁵⁴ in 1635

John Brett⁴⁴³ in 1635

William Brett Jr.⁴⁵⁵ in 1635

William Brett⁴⁵⁶ in 1637

This family is shown as family tree 56.

463. ELIZABETH BRETT [LOWE] (Davis' nine-times-great-grandfather's wife) was born about 1628, in Prince George County, Maryland, to John Lowe Jr.⁶⁷⁴. She is no longer living.
[See also: Indirectly Related via Elizabeth Brett [Lowe]]
 Edmund Brett⁴⁶¹, aged about 68, married Elizabeth Brett [Lowe], aged about 43, on 30 November 1671 in Rattlesden, Suffolk County, England.
464. BARTHELEMY DUPRE (Davis' nine-times-great-grandfather) was born in 1623, in Lot-et-Garonne, France, to Jean DuPre⁴⁷⁶ and Margeurite DuPre [Bessonnet]⁴⁷⁷, as shown in family tree 62. He died in 1701, aged about 78, in Virginia.
465. MATILDA DUPREE [ROBIN] (Davis' nine-times-great-grandmother) was born in 1630, in France. She died in 1654, aged about 24, in France.
 Barthelemy DuPre⁴⁶⁴ married Matilda DuPree [Robin]. They had one son:
 Josias "Joseph" Crancie Dupree⁴⁴⁷ in 1654
This family is shown as family tree 57.
466. AUGUST HERMANN FRANCKE (Davis' nine-times-great-grandfather) was born on 22 March 1663, in Lubeck, Germany, to Johannes Francke⁴⁷⁸ and Anna Francke [Gloxin]⁴⁷⁹, as shown in family tree 63. August was a Protestant religious leader, educator, and social reformer. He died on 8 June 1727, aged 64, in Halle, Germany.
467. ANNA MAGDALENA FRANCKE [VON WURMB] (Davis' nine-times-great-grandmother) was born on 19 November 1670, in Kleinfurra, Thuringia, Germany. She died on 19 March 1734, aged 63, in Halle, Saxony-Anhalt, Germany.
 August Hermann Francke⁴⁶⁶ married Anna Magdalena Francke [von Wurmb]. They had one son:
 John Martin Franck⁴⁴⁹ about 1675
This family is shown as family tree 58.
468. JOHN LEE II (Davis' nine-times-great-great-uncle) was born on 19 September 1616, in St. Martin's Parish, Worcetershire, England, to John Lee Sr.⁴⁷² and Jane Lee [Hancock]⁴⁷³, as shown in family tree 60. He died in 1633, aged about 16.
469. THOMAS LEE (Davis' nine-times-great-great-uncle) was born in 1622 to John Lee Sr.⁴⁷² and Jane Lee [Hancock]⁴⁷³, as shown in family tree 60. He died in 1636, aged about 14.

Generation of Ten-Times-Great-Grandparents

470. RICHARD WOODALL (Davis' ten-times-great-grandfather) was born in 1545, in Warwickshire, England, to Laurence Woodall⁴⁸⁰ and Agnes Woodall [Inu/Light] Light⁴⁸¹, as shown within family tree 59. He died on 20 June 1598, aged about 52, in Warwick, Warwickshire, England.
471. MARY WOODALL [ITHELL] (Davis' ten-times-great-grandmother) was born in 1553. She is no longer living.
 Richard Woodall⁴⁷⁰ married Mary Woodall [Ithell]. They had one son:
 Surgeon General John Woodall⁴⁵⁷ in 1569
This family is shown as family tree 59.
472. JOHN LEE SR. (Davis' ten-times-great-grandfather) was born in 1580, in Nordley Regis, Salop, England, to Richard Lee⁴⁸² and Elizabeth Lee [Bendey]⁴⁸³, as shown in family tree 64. He died on 23 February 1630, aged about 49, in Worcester, Worcestershire, England.
473. JANE LEE [HANCOCK] (Davis' ten-times-great-grandmother) was born in 1594, in Twing, England. She died in 1638, aged about 44, in England.
 John Lee Sr.⁴⁷² married Jane Lee [Hancock]. They had three sons:
 John Lee II⁴⁶⁸ in 1616
 Colonel Richard Henry Lee⁴⁵⁹ in 1618
 Thomas Lee⁴⁶⁹ in 1622
This family is shown as family tree 60.
474. THOMAS BRETT BRITT (Davis' ten-times-great-grandfather) was born about 1573, in Ingestre, Staffordshire, England, to Randle Brett Britt⁴⁸⁴ and Margaret Britt [Chetwynd]⁴⁸⁵, as shown in family tree 65. He is no longer living.
475. URSULA BRITT [COWARD] (Davis' ten-times-great-grandmother) was born in 1584. She died in 1604, aged about 20.
 Thomas Brett Britt⁴⁷⁴, aged about 31, married Ursula Britt [Coward], aged about 20, on 5 July 1604. They had one son:
 Edmund Brett⁴⁶¹ about 1603
This family is shown as family tree 61.
476. JEAN DUPRE (Davis' ten-times-great-grandfather) was born on 20 February 1597, in Ille-et-Vilaine, France, to Louis DuPre⁴⁸⁶ and Elizabeth DuPre [Gonzales]⁴⁸⁷, as shown in family tree 66. He died on 7 November 1674, aged 77, in Saone-et-Loire (Saône-et-Loire), Bourgogne, France.

477. MARGEURITE DUPRE [BESSONET] (Davis' ten-times-great-grandmother) was born in 1590, in Ille-et-Vilaine, France. She died in 1623, aged about 33, in Saone-et-Loire (Saône-et-Loire), Bourgogne, France.
Jean DuPre⁴⁷⁶ married Margeurite DuPre [Bessonnet]. They had one son:
Barthelemy DuPre⁴⁶⁴ in 1623
This family is shown as family tree 62.
478. JOHANNES FRANCKE (Davis' ten-times-great-grandfather) was born on 5 March 1621, in Langenhessen, Zwickau, Sachsen, Germany, to Hans Francke Francke⁴⁸⁸ and Ms. Francke⁴⁸⁹, as shown in family tree 67. Johannes was a Doctor of Laws. He died in 1663, aged about 42, in Lübeck, Schleswig-Holstein, Deutschland, Germany.
479. ANNA FRANCKE [GLOXIN] (Davis' ten-times-great-grandmother) was born on 25 July 1625, in Lubeck, Germany. She died in June 1709, aged 83, in Gotha, Thuringen, Germany.
Johannes Francke⁴⁷⁸ married Anna Francke [Gloxin]. They had one son:
August Hermann Francke⁴⁶⁶ in 1663
This family is shown as family tree 63.

Generation of Eleven-Times-Great-Grandparents

480. LAURENCE WOODALL (Davis' eleven-times-great-grandfather) was born in 1500, in Milton Keynes, Buckinghamshire, England, to Sir John Clois Clowes Clewlowe Clulow⁴⁹⁰ and Lady Isabell Clois Clowes Clewlowe Clulow⁴⁹¹, as shown within family tree 59. He died in 1556, aged about 56, in Buckinghamshire, England.
481. AGNES WOODALL [INU/LIGHT] LIGHT] (Davis' eleven-times-great-grandmother) was born in 1507, in Milton Keynes, Buckinghamshire, England. She died on 25 August 1557, aged about 50, in Sulton Benger, Wiltshire, England.
Laurence Woodall⁴⁸⁰ married Agnes Woodall [Inu/Light] Light]. They had one son:
Richard Woodall⁴⁷⁰ in 1545
This family is shown within family tree 59.
482. RICHARD LEE (Davis' eleven-times-great-grandfather) was born on 10 June 1563, in Coton Hall, Nordley Regis, Shropshire, England, to Sir John "John Lee Esquire" Lee⁴⁹² and Joyce Lee [Romney]⁴⁹³, as shown in family tree 68. He died in 1621, aged about 58, in Alveley Parish, Shropshire, England. He was buried in Chesham, Buckinghamshire, England.
483. ELIZABETH LEE [BENDEY] (Davis' eleven-times-great-grandmother) was born in 1567, in Shrophire, England. She died on 12 April 1630, aged about 62, in Alveley, Shropshire, England. She was buried in Alveley, Shropshire, England.
Richard Lee⁴⁸² married Elizabeth Lee [Bendey]. They had one son:
John Lee Sr.⁴⁷² in 1580
This family is shown as family tree 64.
484. RANDLE BRETT BRITT (Davis' eleven-times-great-grandfather) was born in 1544, in Keele, Staffordshire, England, to Edward Brett⁴⁹⁴ and Cissely Brett [Fitton]⁴⁹⁵, as shown in family tree 69. He died in 1583, aged about 39.
485. MARGARET BRITT [CHETWYND] (Davis' eleven-times-great-grandmother) was born in 1545, in Ingestre, Staffordshire, England. She died in 1656, aged about 111.
Randle Brett Britt⁴⁸⁴, aged about 22, married Margaret Britt [Chetwynd], aged about 21, about 1566 in Ingestre, Staffordshire, England. They had one son:
Thomas Brett Britt⁴⁷⁴ about 1573
This family is shown as family tree 65.
486. LOUIS DUPRE (Davis' eleven-times-great-grandfather) was born in 1561, in Paris, Ile-de-France, France, to Louis Claude DuPre II⁴⁹⁶ and Suzanne DuPre [Moeze]⁴⁹⁷, as shown in family tree 70. He died in 1622, aged about 61, in La Rochelle, Manche, Basse-Normandie, France.
487. ELIZABETH DUPRE [GONZALES] (Davis' eleven-times-great-grandmother) was born in 1570, in Spain. She died in 1630, aged about 60, in Spain.
Louis DuPre⁴⁸⁶ married Elizabeth DuPre [Gonzales]. They had one son:
Jean DuPre⁴⁷⁶ in 1597
This family is shown as family tree 66.
488. HANS FRANCKE FRANCKE (Davis' eleven-times-great-grandfather) was born in 1590, in Thüringen, Deutschland, Germany, to Hermann Francke⁴⁹⁸ and Catherina Francke [Leimbach]⁴⁹⁹, as shown within family tree 67. He died in 1646, aged about 56.
489. MS. FRANCKE (Davis' eleven-times-great-grandmother) was born in 1590. She is no longer living.
Hans Francke Francke⁴⁸⁸ married Ms. Francke. They had one son:
Johannes Francke⁴⁷⁸ in 1621
This family is shown as family tree 67.

Generation of Twelve-Times-Great-Grandparents

490. SIR JOHN CLOIS CLOWES CLEWLOWE CLULOW (Davis' twelve-times-great-grandfather) was born in 1470, in Rudyard, Staffordshire, England. He died about 1550, aged about 80, in Rudyard, Staffordshire, England.
Note: *Sir John Clois/Cloys/Clowes/Clulow/Clewlowe Woodhall/Wudehale/Woodall.*
491. LADY ISABELL CLOIS CLOWES CLEWLOWE CLULOW (Davis' twelve-times-great-grandmother) was born in 1473. She is no longer living.
Sir John Clois Clowes Clewlowe Clulow⁴⁹⁰ married Lady Isabell Clois Clowes Clewlowe Clulow in Middlehum, Staffordshire, England. They had one son:
Laurence Woodall⁴⁸⁰ in 1500
This family is shown within family tree 59.
492. SIR JOHN "JOHN LEE ESQUIRE" LEE (Davis' twelve-times-great-grandfather) was born about 1530, in Coton Hall, Nordley Regis, Shropshire, England, to Sir Humphrey "Humphrey De Lee" Lee⁵⁰⁰ and Katherine Lee [Blount]⁵⁰¹, as shown in family tree 71. Sir became known as "John Lee Esquire". He died in June 1605, aged about 74, in Regis Nordley, Shropshire, England. He was buried in Chesham, Buckinghamshire, England.
493. JOYCE LEE [ROMNEY] (Davis' twelve-times-great-grandmother) was born in 1542, in Lulsley, Worcester, England. She died on 4 December 1609, aged about 67, in Alveley, Coton Nordley Register, Shropshire, England. She was buried in Nordley Regis, Shropshire, England.
Sir John "John Lee Esquire" Lee⁴⁹² married Joyce Lee [Romney]. They had one son:
Richard Lee⁴⁸² in 1563
This family is shown as family tree 68.
494. EDWARD BRETT (Davis' twelve-times-great-grandfather) was born about 1518, in Keele, Staffordshire, England, to Randolphe Brett⁵⁰² and Ann Brett [Woode]⁵⁰³, as shown in family tree 72. He died in 1583, aged about 65, in Dimmesdale, Wolstanton, Staffordshire, England. He was buried in Staffordshire, England.
495. CISSELY BRETT [FITTON] (Davis' twelve-times-great-grandmother) was born about 1522, in Keele, Staffordshire, England. She is no longer living.
Edward Brett⁴⁹⁴ married Cissely Brett [Fitton]. They had one son:
Randle Brett Britt⁴⁸⁴ in 1544
This family is shown as family tree 69.
496. LOUIS CLAUDE DUPRE II (Davis' twelve-times-great-grandfather) was born in 1533, in Paris, Ile-de-France, France, to Louis Claude DuPre I⁵⁰⁴ and Alice DuPre [Jospin]⁵⁰⁵, as shown in family tree 73. He died in 1612, aged about 79, in Manche, Basse-Normandie, France.
497. SUZANNE DUPRE [MOEZE] (Davis' twelve-times-great-grandmother) was born in 1533. She is no longer living.
Louis Claude DuPre II⁴⁹⁶ married Suzanne DuPre [Moeze]. They had one son:
Louis DuPre⁴⁸⁶ in 1561
This family is shown as family tree 70.
498. HERMANN FRANCKE (Davis' twelve-times-great-grandfather) was born on 16 March 1566, in Heldra, Hessen-Nassau, Germany, to Hans Francke⁵⁰⁶ and Eva Francke⁵⁰⁷, as shown within family tree 67. He died in 1591, aged about 25.
499. CATHERINA FRANCKE [LEIMBACH] (Davis' twelve-times-great-grandmother) was born in 1559, in Heldra, Hessen-Nassau, Germany. She died in 1590, aged about 31.
Hermann Francke⁴⁹⁸ married Catherina Francke [Leimbach]. They had one son:
Hans Francke Francke⁴⁸⁸ in 1590
This family is shown within family tree 67.

Generation of Thirteen-Times-Great-Grandparents

500. SIR HUMPHREY "HUMPHREY DE LEE" LEE (Davis' thirteen-times-great-grandfather) was born about 1505, in Coton Hall, Alveley Parish, Nordley Regis, Shropshire, England, to Sir Thomas Lee⁵⁰⁸ and Johanna Lee [Morton]⁵⁰⁹, as shown in family tree 74. Sir became known as "Humphrey De Lee". He died on 12 March 1589, aged about 83, in Nordley Regis, Shropshire, England. He was buried in Shropshire, England.
501. KATHERINE LEE [BLOUNT] (Davis' thirteen-times-great-grandmother) was born about 1506, in Yeo, Hereford, England. She died on 20 August 1591, aged about 85, in Nordley Regis, Shropshire, England. She was buried in Shropshire, England.
Sir Humphrey "Humphrey De Lee" Lee⁵⁰⁰ married Katherine Lee [Blount]. They had one son:
Sir John "John Lee Esquire" Lee⁴⁹² about 1530
This family is shown as family tree 71.

502. RANDOLPHE BRETT (Davis' thirteen-times-great-grandfather) was born in 1492, in Dimmesdale, Wolstanton, Staffordshire, England, to Thomas Brett⁵¹⁰ and Mrs Brett [Baginholde]⁵¹¹, as shown within family tree 72. He is no longer living.
503. ANN BRETT [WOODE] (Davis' thirteen-times-great-grandmother) was born about 1487, in Keele, Staffordshire, England. She died in 1568, aged about 81, in St. Olave, Hart Street, London, England. She was buried in St. Olave, Hart Street, London, England.
 Randolphe Brett⁵⁰², aged about 26, married Ann Brett [Woode], aged about 31, about 1518 in Keele, Staffordshire, England. They had one son:
 Edward Brett⁴⁹⁴ about 1518
This family is shown as family tree 72.
504. LOUIS CLAUDE DUPRE I (Davis' thirteen-times-great-grandfather) was born in 1517, in Paris, France, to Jaques "James" Henre DuPre⁵¹² and Anonette DuPre [Gaillard]⁵¹³, as shown in family tree 75. He died in 1572, aged about 55, in Manche, Basse-Normandie, France.
505. ALICE DUPRE [JOSPIN] (Davis' thirteen-times-great-grandmother) was born in 1517, in France. She is no longer living.
 Louis Claude DuPre I⁵⁰⁴ married Alice DuPre [Jospin]. They had one son:
 Louis Claude DuPre II⁴⁹⁶ in 1533
This family is shown as family tree 73.
506. HANS FRANCKE (Davis' thirteen-times-great-grandfather) was born in 1534, in Alfoldern, Wldck., Germany. He died on 3 January 1575, aged about 40, in Alfoldern, Wldck., Germany.
507. EVA FRANCKE (Davis' thirteen-times-great-grandmother) was born in 1538, in Alfoldern, Wldck., Germany. She died on 20 May 1579, aged about 40, in Alfoldern, Wldck., Germany.
 Hans Francke⁵⁰⁶ married Eva Francke. They had one son:
 Hermann Francke⁴⁹⁸ in 1566
This family is shown within family tree 67.

Generation of Fourteen-Times-Great-Grandparents

508. SIR THOMAS LEE (Davis' fourteen-times-great-grandfather) was born about 1494, in Langley, Acton Burnell, Shropshire, England, to Sir Richard "Recardus /De Lee/Lee" Lee Lee⁵¹⁴ and Margery Sprencheaux Lee [Sprencheaux]⁵¹⁵, as shown in family tree 76. Sir was a Knight. He died on 16 March 1526, aged about 31, in Nordley Regis, Shropshire, England.
509. JOHANNA LEE [MORTON] (Davis' fourteen-times-great-grandmother) was born in 1484, in Haughton, Shropshire, England. She died in 1526, aged about 42, in Nordley Regis, Shropshire, England.
 Sir Thomas Lee⁵⁰⁸ married Johanna Lee [Morton]. They had one son:
 Sir Humphrey "Humphrey De Lee" Lee⁵⁰⁰ about 1505
This family is shown as family tree 74.
510. THOMAS BRETT (Davis' fourteen-times-great-grandfather) was born in 1460, in Dimmesdale, Wolstanton, Staffordshire, England, to Nicolas Brett⁵¹⁶, as shown within family tree 72. He is no longer living.
511. MRS BRETT [BAGINHOLDE] (Davis' fourteen-times-great-grandmother) was born in 1464. She is no longer living.
 Thomas Brett⁵¹⁰ married Mrs Brett [Baginholde]. They had one son:
 Randolphe Brett⁵⁰² in 1492
This family is shown within family tree 72.
512. JAQUES "JAMES" HENRE DUPRE (Davis' fourteen-times-great-grandfather) was born in 1490, in Paris, France, to Jaques Henre DuPre II⁵¹⁷ and Agnes DuPre [Villiers]⁵¹⁸, as shown in family tree 77. Jaques became known as "James". He died in 1567, aged about 77, in Paris, Ile-de-France (Île-de-France), France.
513. ANONETTE DUPRE [GAILLARD] (Davis' fourteen-times-great-grandmother) was born in 1496, in Paris, Ile-de-France (Île-de-France), France. She died in 1543, aged about 47, in France.
 Jaques "James" Henre DuPre⁵¹² married Anonette DuPre [Gaillard]. They had one son:
 Louis Claude DuPre I⁵⁰⁴ in 1517
This family is shown as family tree 75.

Generation of Fifteen-Times-Great-Grandparents

514. SIR RICHARD "RECARDUS /DE LEE/LEE" LEE LEE" (Davis' fifteen-times-great-grandfather) was born in 1432, in Langley, Shropshire, England, to Radolphus "Ralph de Lee" Lee⁵¹⁹ and Isabella Lee [Ridley]⁵²⁰, as shown in family tree 78. He died in 1508, aged about 76, in England.
515. MARGERY SPRENCHÉAUX LEE [SPRENCHÉAUX] (Davis' fifteen-times-great-grandmother) was born in 1441, in Donnington, Shropshire, England. She died in 1512, aged about 71, in Willington, Durham, England.
Sir Richard "Recardus /De Lee/Lee" Lee Lee⁵¹⁴ married Margery Sprencheaux Lee [Sprencheaux]. They had one son:
Sir Thomas Lee⁵⁰⁸ about 1494
This family is shown as family tree 76.
516. NICOLAS BRETT (Davis' fifteen-times-great-grandfather) was born in 1430, in Kelle, Staffordshire, England. He is no longer living.
Nicolas fathered one son:
Thomas Brett⁵¹⁰ in 1460
This family is shown within family tree 72.
517. JAQUES HENRE DUPRE II (Davis' fifteen-times-great-grandfather) was born in 1463, in France, to Sir Josias DuPre⁵²¹ and Lady Maria DuPre [Esteves]⁵²², as shown in family tree 79. He died in 1507, aged about 44, in Nievre (Nièvre), Bourgogne, France.
518. AGNES DUPRE [VILLIERS] (Davis' fifteen-times-great-grandmother) was born in 1435, in France. She died in France.
Jaques Henre DuPre II⁵¹⁷ married Agnes DuPre [Villiers]. They had one son:
Jaques "James" Henre DuPre⁵¹² in 1490
This family is shown as family tree 77.

Generation of Sixteen-Times-Great-Grandparents

519. RADOLPHUS "RALPH DE LEE" LEE (Davis' sixteen-times-great-grandfather) was born between 1438 and 1447, in Langley, Shropshire, England, to Robert "Robert /De Lee/" Lee⁵²⁴ and Petronella "Petronilla Of Lampley /De Lee/" Lee [Pimhall]⁵²⁵, as shown in family tree 80. Radolphus became known as "Ralph de Lee". He died on 14 December 1479, aged about 37, in Langley, Shropshire, England.
520. ISABELLA LEE [RIDLEY] (Davis' sixteen-times-great-grandmother) was born in 1425, in Alkington, Shropshire, England. She died in England.
Radolphus "Ralph de Lee" Lee⁵¹⁹ married Isabella Lee [Ridley]. They had one son:
Sir Richard "Recardus /De Lee/Lee" Lee Lee⁵¹⁴ in 1432
This family is shown as family tree 78.
521. SIR JOSIAS DUPRE (Davis' sixteen-times-great-grandfather) was born in 1433, in Paris, Ile-de-France (Île-de-France), France, to Sir Richard DuPre⁵²⁶ and Paschale DuPre [DeVermondois]⁵²⁷, as shown in family tree 81. He died in 1507, aged about 74, in Paris, Ile-de-France (Île-de-France), France.
522. LADY MARIA DUPRE [ESTEVEVES] (Davis' sixteen-times-great-grandmother) was born in 1435, in Bourgogne, France. She died in 1475, aged about 40, in Bourgogne, France.
Sir Josias DuPre⁵²¹ married Lady Maria DuPre [Esteves]. They had one son:
Jaques Henre DuPre II⁵¹⁷ in 1463
This family is shown as family tree 79.
523. RICHARD DE VERMONDOIS DUPRE II (Davis' sixteen-times-great-great-uncle) was born to Sir Richard DuPre⁵²⁶ and Paschale DuPre [DeVermondois]⁵²⁷, as shown in family tree 81. He is no longer living.

Generation of Seventeen-Times-Great-Grandparents

524. ROBERT "ROBERT /DE LEE/" LEE " (Davis' seventeen-times-great-grandfather) was born about 1392, in Coton, Nordley Regis, Shropshire, England, to Roger "Robert" de Lee⁵²⁸ and Margaret "Margaret de Astley" de Lee [Astley]⁵²⁹, as shown in family tree 82. He died in 1429, aged about 37, in Langley, Shropshire, England.
525. PETRONELLA "PETRONILLA OF LAMPLEY /DE LEE/" LEE [PIMHALL] " (Davis' seventeen-times-great-grandmother) was born in 1374, in Langley, Cheshire, England. She died in 1442, aged about 68, in England.
Robert "Robert /De Lee/" Lee⁵²⁴ married Petronella "Petronilla Of Lampley /De Lee/" Lee [Pimhall] ". They had one son:
Radolphus "Ralph de Lee" Lee⁵¹⁹ about 1442
This family is shown as family tree 80.

526. SIR RICHARD DUPRE (Davis' seventeen-times-great-grandfather) was born in 1400, in France, to Gillies Lord of Pereins Du Puy II⁵³⁰ and Lady Marie Florence Du Puy [de Hauteville]⁵³¹, as shown in family tree 83. He died in 1471, aged about 71, in Bourgogne, France.
 Note: *After the Battle of Agincourt (1415), the French aristocracy fell into some disarray. Many French landowners who did not bear coat armour found themselves raised to the level of seigneur because they began to fulfill legal and judicial duties to fill the power vacuum. Richard DuPREE was granted a coat of arms in 1437. He may well have married into the aristocratic Vermondois family. His son Richard (II) styled himself Richard de Vermondois du Pre.*
527. PASCHALE DUPRE [DEVERMONDOIS] (Davis' seventeen-times-great-grandmother) was born in 1405, in Vermondois, France. She died in France.
 Sir Richard DuPre⁵²⁶ married Paschale DuPre [DeVermondois] in Poland. They had two sons:
 Sir Josias DuPre⁵²¹ in 1433
 Richard de Vermondois DuPre II⁵²³
This family is shown as family tree 81.

Generation of Eighteen-Times-Great-Grandparents

528. ROGER "ROBERT" DE LEE (Davis' eighteen-times-great-grandfather) was born about 1376, in Roden, Stanton, Shropshire, England, to John de la Lee II⁵³² and Margaret de la Lee⁵³³, as shown in family tree 84. Roger became known as "Robert". Roger was a High Sheriff of Shropshire. He died in 1420, aged about 44, in Nordley Regis, Shropshire, England.
529. MARGARET "MARGARET DE ASTLEY" DE LEE [ASTLEY] (Davis' eighteen-times-great-grandmother) was born about 1354, in Coton Hall, Nordley Regis, Shropshire, England. Margaret became known as "Margaret de Astley". She died in 1423, aged about 69, in Nordley Regis, Shropshire, England.
 Roger "Robert" de Lee⁵²⁸ married Margaret "Margaret de Astley" de Lee [Astley]. They had one son:
 Robert "Robert /De Lee/" Lee "⁵²⁴ about 1392
This family is shown as family tree 82.
530. GILLIES LORD OF PEREINS DU PUY II (Davis' eighteen-times-great-grandfather) was born in 1366, in Pereins, Drome (Drôme), France, to Gilles Lord of Rochefort Du Puy I, Knight⁵³⁴ and Alix Du Puy [de Bellecombe]⁵³⁵, as shown in family tree 85. He died on 13 May 1420, aged about 53, in France.
531. LADY MARIE FLORENCE DU PUY [DE HAUTEVILLE] (Davis' eighteen-times-great-grandmother) was born in 1378, in Peyrins, (Drôme), Rhone-Alps, France. She died in 1477, aged about 99, in Pereins, (Drôme), Rhone-Alps, France.
 Gillies Lord of Pereins Du Puy II⁵³⁰ married Lady Marie Florence Du Puy [de Hauteville]. They had one son:
 Sir Richard DuPre⁵²⁶ in 1400
This family is shown as family tree 83.

Generation of Nineteen-Times-Great-Grandparents

532. JOHN DE LA LEE II (Davis' nineteen-times-great-grandfather) was born between 1326 and 1366 to Sir Thomas de la Lee⁵³⁶ and Petronilla de la Lee [Corbet]⁵³⁷, as shown in family tree 86. He died in 1424, aged about 77.
533. MARGARET DE LA LEE (Davis' nineteen-times-great-grandmother) was born between 1311 and 1371. She is no longer living.
 John de la Lee II⁵³² married Margaret de la Lee. They had one son:
 Roger "Robert" de Lee⁵²⁸ about 1376
This family is shown as family tree 84.
534. GILLES LORD OF ROCHEFORT DU PUY I, KNIGHT (Davis' nineteen-times-great-grandfather) was born in 1330, in Rochefort, Allier, Auvergne, France, to Lord Alleman Du Puy V⁵³⁸ and Ainarde Du Puy [De Roland]⁵³⁹, as shown in family tree 87. He died in 1397, aged about 67, in Pereins, Drôme, Ardèche, Rhône-Alpes (Région), France.
535. ALIX DU PUY [DE BELLECOMBE] (Davis' nineteen-times-great-grandmother) was born in 1335, in Pereins, France. She died in 1390, aged about 55, in France.
 Gilles Lord of Rochefort Du Puy I, Knight⁵³⁴, aged about 30, married Alix Du Puy [de Bellecombe], aged about 25, in 1360. They had one son:
 Gillies Lord of Pereins Du Puy II⁵³⁰ in 1366
This family is shown as family tree 85.

Generation of Twenty-Times-Great-Grandparents

536. SIR THOMAS DE LA LEE (Davis' twenty-times-great-grandfather) was born in 1224, in Alderton Hall, Lea Hall, Pimhill, Salop, England, to Sir John "John Lee Esquire" de la Lee⁵⁴⁰ and Rei Mnu de la Lee⁵⁴¹, as shown in family tree 88. Sir was a Sheriff. He died in 1258, aged about 34, in Salop, Shropshire, England.
537. PETRONILLA DE LA LEE [CORBET] (Davis' twenty-times-great-grandmother) was born about 1238, in Moreton Corbet, Shropshire, England. She died in 1319, aged about 81, in Alderton, Gloucestershire, England.
Sir Thomas de la Lee⁵³⁶ married Petronilla de la Lee [Corbet]. They had one son:
John de la Lee II⁵³² about 1346
This family is shown as family tree 86.
538. LORD ALLEMAN DU PUY V (Davis' twenty-times-great-grandfather) was born in 1290, in Pereins, Drôme, Rhone-Alpes, France, to Chevalier Alleman Du Puy IV⁵⁴² and Eleanore Alleman Du Puy [de Lancoil]⁵⁴³, as shown in family tree 89. He died in 1362, aged about 72, in Rochefort, Allier, Auvergne, France.
539. AINARDE DU PUY [DE ROLAND] (Davis' twenty-times-great-grandmother) was born in 1310, in Pereins, France. She died in 1362, aged about 52, in France.
Lord Alleman Du Puy V⁵³⁸, aged about 35, married Ainarde Du Puy [De Roland], aged about 15, in 1325. They had one son:
Gilles Lord of Rochefort Du Puy I, Knight⁵³⁴ in 1330
This family is shown as family tree 87.

Generation of Twenty-one-Times-Great-Grandparents

540. SIR JOHN "JOHN LEE ESQUIRE" DE LA LEE (Davis' twenty-one-times-great-grandfather) was born in 1195, in Lea Hall, Shropshire, England, to Reginald "Reginald Reynor de la Lea" de Laga⁵⁴⁴ and Rei Lega de Laga⁵⁴⁵, as shown in family tree 90. Sir became known as "John Lee Esquire". He died in 1301, aged about 106, in Cheshire, England.
541. REI MNU DE LA LEE (Davis' twenty-one-times-great-grandmother) was born about 1162, in England. She died in 1203, aged about 41, in England.
Sir John "John Lee Esquire" de la Lee⁵⁴⁰ married Rei Mnu de la Lee. They had one son:
Sir Thomas de la Lee⁵³⁶ in 1224
This family is shown as family tree 88.
542. CHEVALIER ALLEMAN DU PUY IV (Davis' twenty-one-times-great-grandfather) was born in 1250, in Drome, Rhone-Alpes, France, to Alleman Sgr. of Bordeau Du Puy III⁵⁴⁶ and Beatrix Tournon Du Puy [Artod]⁵⁴⁷, as shown in family tree 91. He died in 1329, aged about 79.
Note: *Alleman IV, Knight, Lord of Pereins, Rochefort, Apifer, Ansenis=x and Consrien. He was with the Count of Valentinois under King Phillippe V, who marched against the people of Flamaus in 1316. He was routed in 1329 on the journey to Cassel.*
543. ELEANORE ALLEMAN DU PUY [DE LANCOIL] (Davis' twenty-one-times-great-grandmother) was born in 1275. She died in 1321, aged about 46.
Chevalier Alleman Du Puy IV⁵⁴², aged about 35, married Eleanore Alleman Du Puy [de Lancoil], aged about 10, in 1285. They had one son:
Lord Alleman Du Puy V⁵³⁸ in 1290
This family is shown as family tree 89.

Generation of Twenty-two-Times-Great-Grandparents

544. REGINALD "REGINALD REYNOR DE LA LEA" DE LAGA (Davis' twenty-two-times-great-grandfather) was born about 1160, in Lea Hall, Shropshire, England, to Hugo "Hugo de La Lea /de Lee/" de Laga⁵⁴⁸ and Christian De Stainton de Laga⁵⁴⁹, as shown in family tree 92. Reginald became known as "Reginald Reynor de la Lea". Reginald was a Sheriff of Shropshire in 1201. He died in 1203, aged about 43, in Shrewsbury, Shropshire, England.
545. REI LEGA DE LAGA (Davis' twenty-two-times-great-grandmother) was born in 1162, in Lea Hall, Shropshire, England. She died in 1203, aged about 41, in Shrewsbury, Shropshire, England.
Reginald "Reginald Reynor de la Lea" de Laga⁵⁴⁴ married Rei Lega de Laga. They had one son:
Sir John "John Lee Esquire" de la Lee⁵⁴⁰ in 1195
This family is shown as family tree 90.
546. ALLEMAN SGR. OF BORDEAU DU PUY III (Davis' twenty-two-times-great-grandfather) was born in 1210, in Pereins,

Drome, Rhone-Alpes, France, to Chevalier Alleman de Montbrun Seigneur de Pereins Du Puy II⁵⁵⁰ and Alix Princess of Dauphine Du Puy⁵⁵¹, as shown in family tree 93. He died on 23 September 1304, aged about 94, in France.

Note: *Alleman II du Puy, chevalier, seigneur de Pereins, Rochefort, Apifer, Montbrun, Rhelianete, Baux, Solignac, Bruis, Bordeaux, Ansenix, et Conifrieu, used the name Humbert. Dauphin, his cousin, made a treaty with the count of Savoy. Dauphin lent Humbert money so he could have his sister marry the count de Forez. Per his will of 1304, he shared with his brother Ainier, the inheritance they received from their father, Alleman, and those which they had acquired from their cousin, Guillaume, who had established himself at Berri. He married Beatrix Artod, daught of Pierre-Yfoard Artod, seigneur of Glandage and Alix of Tournon.*

547. BEATRIX TOURNON DU PUY [ARTOD] (Davis' twenty-two-times-great-grandmother) was born in 1210, in Glandage, Drome, Rhone-Alpes, France. She died in 1293, aged about 83, in France.
Alleman Sgr. of Bordeau Du Puy III⁵⁴⁶, aged about 35, married Beatrix Tournon Du Puy [Artod], aged about 35, in 1245. They had one son:
Chevalier Alleman Du Puy IV⁵⁴² in 1250
This family is shown as family tree 91.

Generation of Twenty-three-Times-Great-Grandparents

548. HUGO "HUGO DE LA LEA /DE LEE/" DE LEGA " (Davis' twenty-three-times-great-grandfather) was born in 1140, in Stanton, Roden, Shropshire, England, to Sir Fulk Marcher Lord of Whittington and Alveston FitzWarin III⁵⁵² and Eva FitzWarin [de Blancminister Warrine]⁵⁵³, as shown in family tree 94. Hugo was a Knight. He died in 1182, aged about 42, in England.
549. CHRISTIAN DE STAINTON DE LEGA (Davis' twenty-three-times-great-grandmother) was born about 1142, in Lorraine, France. She died in 1203, aged about 61.
Hugo "Hugo de La Lea /de Lee/" de Lega "⁵⁴⁸ married Christian De Stainton de Lega. They had one son:
Reginald "Reginald Reynor de la Lea" de Laga⁵⁴⁴ about 1160
This family is shown as family tree 92.
550. CHEVALIER ALLEMAN DE MONTBRUN SEIGNEUR DE PEREINS DU PUY II (Davis' twenty-three-times-great-grandfather) was born in 1170 to Chevalier Hugues Apifer & Montbrun Du Puy II , Seigneur de Pereins, Rochefort⁵⁵⁴ and Floride Du Puy [De Morian]⁵⁵⁵, as shown in family tree 95. He died in 1229, aged about 59.
Note: *He was also known as Montbrun. Alleman II du Puy, knight, Lord of Pereins, Rochefort, Apifer and Montbrun, was known as Montbrun. He rendered homage, in 1229, to Aimar de Poitiers, count of Balentinois and Diois. He acquired fiefs and other grants near Pereins, from his uncle Guillaume Du Puy. In the contracts of acquissition, he was identified as son of Hughes du Puy and grandson of Alleman du Puy and the said Guillaume was said to be the son of Alleman the first.*
551. ALIX PRINCESS OF DAUPHINE DU PUY (Davis' twenty-three-times-great-grandmother) was born in 1180. She is no longer living.
Chevalier Alleman de Montbrun Seigneur de Pereins Du Puy II⁵⁵⁰, aged about 35, married Alix Princess of Dauphine Du Puy, aged about 25, in 1205. They had one son:
Alleman Sgr. of Bordeau Du Puy III⁵⁴⁶ in 1210
This family is shown as family tree 93.

Generation of Twenty-four-Times-Great-Grandparents

552. SIR FULK MARCHER LORD OF WHITTINGTON AND ALVESTON FITZWARIN III (Davis' twenty-four-times-great-grandfather) was born between 1160 and 1165, in Whittington Castle, Shropshire, England, to Fulk II "Brunin" Lord of Whittington and Alveston FitzWarin II⁵⁵⁶ and Hawise FitzWarin [de Dinan]⁵⁵⁷, as shown in family tree 96. Sir was a Marcher lord, seated at Whittington Castle, Shropshire, England, Knight. He died (Blindness) in 1258, aged about 95, in Whittington, Shropshire, England.
Note: *"Robin Hood / Fulke", "Fouke", "FitzWaryn", "FitzWarren", "Fitz Warine", "Fouke le Fitz Waryn", "alias Fulke", "Fulke", "FitzWarren and Fitz Warine", "Legend of Robin Hood is based on his life".*
553. EVA FITZWARIN [DE BLANCMINISTER WARRINE] (Davis' twenty-four-times-great-grandmother) was born between 1102 and 1140. She is no longer living.
Sir Fulk Marcher Lord of Whittington and Alveston FitzWarin III⁵⁵² married Eva FitzWarin [de Blancminister Warrine]. They had one son:
Hugo "Hugo de La Lea /de Lee/" de Lega "⁵⁴⁸ in 1140
This family is shown as family tree 94.
554. CHEVALIER HUGUES APIFER & MONTBRUN DU PUY II , SEIGNEUR DE PEREINS, ROCHEFORT (Davis'

twenty-four-times-great-grandfather) was born in 1130 to Chevalier Alleman Du Puy I⁵⁵⁸ and Lady Veronique Ademar Du Puy⁵⁵⁹, as shown in family tree 97. He died in 1180, aged about 50.

Note: *Hughes II, chevalier, seigneur de Pereins, Rochefort, Apifer and Montbrun, went on the crusades in 1140 with Ame III, Count of Savoy, and acquired great glory in 1147, in the army of emperor Conrad III. He allied himself, both defensively and offensively, with the house of Clermont-Tennere. He married Floride Moiran, daughter of Berlion de Moiran.*

555. FLORIDE DU PUY [DE MORIAN] (Davis' twenty-four-times-great-grandmother).

Chevalier Hugues Apifer & Montbrun Du Puy II, Seigneur de Pereins, Rochefort⁵⁵⁴, aged about 35, married Floride Du Puy [De Morian] in 1165. They had one son:

Chevalier Alleman de Montbrun Seigneur de Pereins Du Puy II⁵⁵⁰ in 1170

This family is shown as family tree 95.

Generation of Twenty-five-Times-Great-Grandparents

556. FULK II "BRUNIN" LORD OF WHITTINGTON AND ALVESTON FITZWARIN II (Davis'

twenty-five-times-great-grandfather) was born about 1138, in Whittington Castle, Whittington, Shropshire, England, to Fulk "Fulko" FitzWarin I, Lord of Whittington and Alderbury, "Guarine de Meer"⁵⁶⁰ and Miletta de Whittington FitzWarin [de Whittington]⁵⁶¹, as shown in family tree 98. Fulk became known as "Brunin". Fulk was a Knight. He died on 6 November 1197, aged about 59, in Thornbury, Gloucestershire, England.

557. HAWISE FITZWARIN [DE DINAN] (Davis' twenty-five-times-great-grandmother) was born in 1147, in Dinan, Ille Et Vilaine, Bretagne, France. She died in 1226, aged about 79, in Whittington, Shropshire, England.

Fulk II "Brunin" Lord of Whittington and Alveston FitzWarin II⁵⁵⁶ married Hawise FitzWarin [de Dinan]. They had one son:

Sir Fulk Marcher Lord of Whittington and Alveston FitzWarin III⁵⁵² about 1162

This family is shown as family tree 96.

558. CHEVALIER ALLEMAN DU PUY I (Davis' twenty-five-times-great-grandfather) was born in 1077 to Hugues Lord of Rochefort Du Puy I⁵⁶² and Deurard DE POISIEU Du Puy⁵⁶³, as shown in family tree 99. He died in 1150, aged about 73.

Note: *Alleman I, clevalier, seigneur de pereins, d'Apifer et de Rochefort, was no less avlorous than his brothers. He went to the aid of his wife's relatives, Giraud Adhemar and Biraudet, who were being besieged by Guillaume, count de Forcalquier. He fought in many battles on many occasions in 1115. He married Veronique Adhemar, sister of Giraud. She received as her dowry, Montbrun and many other lands, which were separated from the estates of Adhemar.*

He was married to Veronique ADEMAR (daughter of Gerard ADEMAR) in 1125. Veronique ADEMAR was born about 1095. Veronique as the niece of Bishop Ademar le Puy, the spiritual leader of the first Crusade.

559. LADY VERONIQUE ADEMAR DU PUY (Davis' twenty-five-times-great-grandmother). She is no longer living.

Chevalier Alleman Du Puy I⁵⁵⁸, aged about 48, married Lady Veronique Ademar Du Puy in 1125. They had one son:

Chevalier Hugues Apifer & Montbrun Du Puy II, Seigneur de Pereins, Rochefort⁵⁵⁴ in 1130

This family is shown as family tree 97.

Generation of Twenty-six-Times-Great-Grandparents

560. FULK "FULKO" FITZWARIN I, LORD OF WHITTINGTON AND ALDERBURY, "GUARINE DE MEER" (Davis' twenty-six-times-great-grandfather) was born about 1110, in Bramley, Shropshire, England, to Sir Guy Warin "the Bold" de Metz⁵⁶⁴ and Baroness Melette Maud, Heiress of Whittington, "Maud de Ingelrica" de Metz [Peverell]⁵⁶⁵, as shown in family tree 100. He died in 1170, aged about 60, in Alveston, Gloucestershire, England.

561. MILETTA DE WHITTINGTON FITZWARIN [DE WHITTINGTON] (Davis' twenty-six-times-great-grandmother) was born in 1116, in Whittington, Shropshire, England. She is no longer living.

Fulk "Fulko" FitzWarin I, Lord of Whittington and Alderbury, "Guarine de Meer"⁵⁶⁰ married Miletta de Whittington FitzWarin [de Whittington]. They had one son:

Fulk II "Brunin" Lord of Whittington and Alveston FitzWarin II⁵⁵⁶ about 1138

This family is shown as family tree 98.

562. HUGUES LORD OF ROCHEFORT DU PUY I (Davis' twenty-six-times-great-grandfather) was born in 1055, in Pereins, France, to Grand Chamberlain Conrad II Raphael (del Poggio) Du Puy⁵⁶⁶ and Pétronille de Archaic] Du Puy, Countess of Conteville [de Bérengs⁵⁶⁷, as shown in family tree 101. He died in 1110, aged about 55.

Note: *Hughes founded the Abbey d'Aiguebelle, Order of Saint Bernard. He went to the Crusades with three of his children and his wife. He was one of the Generals of "Godofroi de Bouillon, and for bravery was granted the Souverainete la ville d'Acres.*

From a guide in Israel it was told that there were three Souverainetes in Acre or Akko as it is known today. He was the "Mayor" of the city.

Other histories state he was killed in battle in Palestine in 1097.

563. DEURARD DE POISIEU DU PUY (Davis' twenty-six-times-great-grandmother). She is no longer living. Hugues Lord of Rochefort Du Puy I⁵⁶², aged about 20, married Deurard DE POISIEU Du Puy in 1075. They had one son: Chevalier Alleman Du Puy I⁵⁵⁸ in 1077
This family is shown as family tree 99.

Generation of Twenty-seven-Times-Great-Grandparents

564. SIR GUY WARIN "THE BOLD" DE METZ (Davis' twenty-seven-times-great-grandfather) was born about 1079, in Metz, France, to Warine "The Sherriff" de Metz⁵⁶⁸ and Aimeria Emma de Montgomery de Metz [de Montgomery]⁵⁶⁹, as shown in family tree 102. Sir became known as "the Bold". He died in 1115, aged about 36, in Bramly, Shropshire, England.
565. BARONESS MELETTE MAUD ,HEIRESS OF WHITTINGTON, "MAUD DE INGELRICA" DE METZ [PEVERELL] (Davis' twenty-seven-times-great-grandmother) was born in 1075, in Brunne, Cambridgeshire, England. Baroness became known as "Maud de Ingelrica". She died in 1178, aged about 103, in Albeny, France.
Sir Guy Warin "the Bold" de Metz⁵⁶⁴ married Baroness Melette Maud,Heiress of Whittington, "Maud de Ingelrica" de Metz [Peverell]. They had one son:
Fulk "Fulko" FitzWarin I, Lord of Whittington and Alderbury, "Guarine de Meer"⁵⁶⁰ about 1110
This family is shown as family tree 100.
566. GRAND CHAMBERLAIN CONRAD II RAPHAEL (DEL POGGIO) DU PUY (Davis' twenty-seven-times-great-grandfather) was born in 1011 to Raymond Guillaume de podio⁵⁷⁰ and Amelie de podio [de Heitz]⁵⁷¹, as shown in family tree 103. He died in 1062, aged about 51.
Note: *Du Puy was Commander of Roman Cavalry.*

The Tomb of Raphael du Puy was opened in 1610 by order of M. Le Compte de la roche, "Goureneur de Romans en Dauphine". The corpse was found extended pon a marble table, his spurs upon one side, his sword upon the other, and upon his head a helmet of lead containing the following inscription upon a copper place. It is said the "House of DuPuy en Dauphine" posses a gold medal granted to this Raphael DuPuy upon one side of which is written: "Raphael de Podio, grand Chambellan de l'Empire Romaine Sons l'Empereur, Auguste, Christ regnant en chair".

567. PÉTRONILLE DE ARCHAIC] DU PUY, COUNTESS OF CONTEVILLE [DE BÉRENGS (Davis' twenty-seven-times-great-grandmother) was born in 994, in Conteville, Eure, Upper Normandy, France. She died in 1048, aged about 54.
Grand Chamberlain Conrad II Raphael (del Poggio) Du Puy⁵⁶⁶ married Pétronille de Archaic] Du Puy, Countess of Conteville [de Bérengs. They had one son:
Hugues Lord of Rochefort Du Puy I⁵⁶² in 1055
This family is shown as family tree 101.

Generation of Twenty-eight-Times-Great-Grandparents

568. WARINE "THE SHERRIFF" DE METZ (Davis' twenty-eight-times-great-grandfather) was born in 1050, in Metz, Moselle, Alsace-Champagne-Ardenne-Lorraine, France. Warine became known as "The Sherriff". He died in 1115, aged about 65, in Bramley, Hampshire, England.
569. AIMERIA EMMA DE MONTGOMERY DE METZ [DE MONTGOMERY] (Davis' twenty-eight-times-great-grandmother) was born about 1035, in Saint-Germain-de-Montgommery, Calvados, Normandy, France, to Gilbert de Montgomery⁵⁷² and Joseline de Montgomery [de Vetulis]⁵⁷³, as shown in family tree 104. She died in 1084, aged about 49, in England.
Warine "The Sherriff" de Metz⁵⁶⁸ married Aimeria Emma de Montgomery de Metz [de Montgomery]. They had one son:
Sir Guy Warin "the Bold" de Metz⁵⁶⁴ about 1079
This family is shown as family tree 102.
570. RAYMOND GUILLAUME DE PODIO (Davis' twenty-eight-times-great-grandfather) was born in 980 to Guillaume de podio del puech⁵⁷⁴ and Berchta de podio del puech [d'Opfikon]⁵⁷⁵, as shown in family tree 105. He died in 1050, aged about 70.
571. AMELIE DE PODIO [DE HEITZ] (Davis' twenty-eight-times-great-grandmother) was born between 941 and 995. She is no longer living.
Raymond Guillaume de podio⁵⁷⁰ married Amelie de podio [de Heitz]. They had one son:
Grand Chamberlain Conrad II Raphael (del Poggio) Du Puy⁵⁶⁶ in 1011
This family is shown as family tree 103.

Generation of Twenty-nine-Times-Great-Grandparents

572. GILBERT DE MONTGOMERY (Davis' twenty-nine-times-great-grandfather) was born between 985 and 1035 to Hugh I de Montgomery⁵⁷⁶ and Joscelina de Montgomery [de Normandie]⁵⁷⁷, as shown in family tree 106. He died in 1064, aged about 53, in Normandy, France.
573. JOSELINE DE MONTGOMERY [DE VETULIS] (Davis' twenty-nine-times-great-grandmother) was born in 1016, in France. She died in 1100, aged about 84, in France.
 Gilbert de Montgomery⁵⁷² married Joseline de Montgomery [de Vetulis]. They had one daughter:
 Aimeria Emma de Montgomery de Metz [de Montgomery]⁵⁶⁹ about 1035
This family is shown as family tree 104.
574. GUILLAUME DE PODIO DEL PUECH (Davis' twenty-nine-times-great-grandfather) was born between 915 and 975 to Amelius Simplious (de Pugio) de podio del puech⁵⁷⁸ and Jeanne de podio del puech [d'Archingaux]⁵⁷⁹, as shown in family tree 107. He is no longer living.
575. BERCHTA DE PODIO DEL PUECH [D'OPFIKON] (Davis' twenty-nine-times-great-grandmother) was born between 915 and 975. She is no longer living.
 Guillaume de podio del puech⁵⁷⁴ married Berchta de podio del puech [d'Opfikon]. They had one son:
 Raymond Guillaume de podio⁵⁷⁰ in 980
This family is shown as family tree 105.

Generation of Thirty-Times-Great-Grandparents

576. HUGH I DE MONTGOMERY (Davis' thirty-times-great-grandfather) was born in 980, in Saint-Germain, Yvelines, Île-de-France, France, to William de Montgomery⁵⁸⁰ and Elizabeth de Montgomery [de Tripon]⁵⁸¹, as shown in family tree 108. He is no longer living.
577. JOSCELINA DE MONTGOMERY [DE NORMANDIE] (Davis' thirty-times-great-grandmother) was born between 943 and 1003, in Normandy, France. She is no longer living.
 Hugh I de Montgomery⁵⁷⁶ married Joscelina de Montgomery [de Normandie]. They had one son:
 Gilbert de Montgomery⁵⁷² about 1010
This family is shown as family tree 106.
578. AMELIUS SIMPLIOUS (DE PUGIO) DE PODIO DEL PUECH (Davis' thirty-times-great-grandfather) was born before 975 to Norman Anglo saxony (de Pugio) de podio del puech⁵⁸², as shown in family tree 109. He is no longer living.
579. JEANNE DE PODIO DEL PUECH [D'ARCHINGAUX] (Davis' thirty-times-great-grandmother) was born before 975. She is no longer living.
 Amelius Simplious (de Pugio) de podio del puech⁵⁷⁸ married Jeanne de podio del puech [d'Archingaux]. They had one son:
 Guillaume de podio del puech⁵⁷⁴ about 945
This family is shown as family tree 107.

Generation of Thirty-one-Times-Great-Grandparents

580. WILLIAM DE MONTGOMERY (Davis' thirty-one-times-great-grandfather) was born in 955 to Roger III de Montgomery⁵⁸³, as shown in family tree 110. He is no longer living.
581. ELIZABETH DE MONTGOMERY [DE TRIPON] (Davis' thirty-one-times-great-grandmother) was born between 920 and 980. She is no longer living.
 William de Montgomery⁵⁸⁰ married Elizabeth de Montgomery [de Tripon]. They had one son:
 Hugh I de Montgomery⁵⁷⁶ in 980
This family is shown as family tree 108.
582. NORMAN ANGLO SAXONY (DE PUGIO) DE PODIO DEL PUECH (Davis' thirty-one-times-great-grandfather) was born before 975 to Adminius Amminius de podio del puech⁵⁸⁴, as shown within family tree 109. He is no longer living.
 Norman fathered one son:
 Amelius Simplious (de Pugio) de podio del puech⁵⁷⁸ before 975
This family is shown as family tree 109.

Generation of Thirty-two-Times-Great-Grandparents

583. ROGER III DE MONTGOMERY (Davis' thirty-two-times-great-grandfather) was born in 930 to Roger II de Montgomery⁵⁸⁵, as shown within family tree 110. He is no longer living.

Roger fathered one son:

William de Montgomery⁵⁸⁰ in 955

This family is shown as family tree 110.

584. ADMINIUS AMMINIUS DE PODIO DEL PUECH (Davis' thirty-two-times-great-grandfather) was born before 975 to Gaius Suetonius Paulinus de Pugio⁵⁸⁶, as shown within family tree 109. He is no longer living.

Adminius fathered one son:

Norman Anglo saxony (de Pugio) de podio del puech⁵⁸² before 975

This family is shown within family tree 109.

Generation of Thirty-three-Times-Great-Grandparents

585. ROGER II DE MONTGOMERY (Davis' thirty-three-times-great-grandfather) was born in 900 to Roger I de Montgomery⁵⁸⁷, as shown within family tree 110. He is no longer living.

Roger fathered one son:

Roger III de Montgomery⁵⁸³ in 930

This family is shown within family tree 110.

586. GAIUS SUETONIUS PAULINUS DE PUGIO (Davis' thirty-three-times-great-grandfather) was born before 975. He is no longer living.

Gaius fathered one son:

Adminius Amminius de podio del puech⁵⁸⁴ before 975

This family is shown within family tree 109.

Generation of Thirty-four-Times-Great-Grandparents

587. ROGER I DE MONTGOMERY (Davis' thirty-four-times-great-grandfather) was born in 870. He is no longer living.

Roger fathered one son:

Roger II de Montgomery⁵⁸⁵ in 900

This family is shown within family tree 110.

5. INDIRECTLY RELATED via KAREN DENISE WOODALL [MOORE] ⁵²
(Davis' wife)

Generation of Davis' Grandchildren

588. EASTON NEAL MOORE (Karen's great-nephew) was born on 21 July 2021 to Ryan Neal Moore⁵⁹⁰ and Heather Moore [Millsaps]⁵⁹¹.

Generation of Davis' Children

589. BRODY MATTHEW MOORE (Karen's nephew) was born on 30 January 2011 to Steven Neal Moore⁵⁹⁷ and Kristen Moore⁵⁹⁸.

590. RYAN NEAL MOORE (Karen's nephew) was born on 23 February 1990 to Roy Neal Moore III⁵⁹⁹ and Deborah Joanne Moore [Cratch]⁶⁰⁰.

591. HEATHER MOORE [MILLSAPS] (Karen's nephew's wife).
Ryan Neal Moore⁵⁹⁰ married Heather Moore [Millsaps]. They had one son:
Easton Neal Moore⁵⁸⁸ in 2021

592. SHANNEN JEAN MOORE (Karen's niece) was born on 13 May 1994 to Roy Neal Moore III⁵⁹⁹ and Deborah Joanne Moore [Cratch]⁶⁰⁰.

593. TAYLOR FRANCESCANGELI (Karen's cousin, once removed) was born in 1995 to Barry R Francescangeli⁶⁰⁹ and Angela Goffredo [Pumroy]⁶⁰⁷.

594. RACHEL TIFFANY MELLOR (Karen's cousin, once removed) was born in 1980 to Richard A Mellor⁶¹⁰ and Angela Goffredo [Pumroy]⁶⁰⁷.

595. WILLIAM EDWARD "WILL" WILSON III (Karen's cousin, once removed) was born on 18 December 1995 to William Edward "Billy" Wilson Jr.⁶¹¹ and Frances Wilson [Hawes]⁶¹². William became known as "Will".

596. RIPLEY WILSON (Karen's cousin, once removed) was born to Patrick "Brian" Wilson⁶¹³ and Amber Wilson [Powell]⁶¹⁴.

Generation of Davis's Peers

597. STEVEN NEAL MOORE (Karen's half-brother) was born to Roy Neal Moore Jr.⁶¹⁵ and Lora Ann Moore [Gray]⁶¹⁷.

598. KRISTEN MOORE (Karen's sister-in-law).
Steven Neal Moore⁵⁹⁷ married Kristen Moore. They had one son:
Brody Matthew Moore⁵⁸⁹ in 2011

599. ROY NEAL MOORE III (Karen's brother) was born on 21 May 1959 to Roy Neal Moore Jr.⁶¹⁵ and Betty Jean "BJ" Moore [Wilson]⁶¹⁶.

Roy married twice. He was married to Deborah Joanne Moore [Cratch]⁶⁰⁰ and Sharon Moore [Mitchell]⁶⁰¹.

600. DEBORAH JOANNE MOORE [CRATCH] (Karen's sister-in-law) was born on 31 July 1960. She died (Breast Cancer) on 19 February 2003, aged 42. She was buried in Kennebec Baptist Church Cemetary, Angier, North Carolina.
Roy Neal Moore III⁵⁹⁹, aged 30, married Deborah Joanne Moore [Cratch], aged 29, on 19 August 1989 in Pleasant Grove Baptist Church, Fuquay Varina, North Carolina, and they were divorced. They had two children:

Ryan Neal Moore⁵⁹⁰ in 1990

Shannen Jean Moore⁵⁹² in 1994

601. SHARON MOORE [MITCHELL] (Karen's sister-in-law) was born on 18 September 1960.

Sharon married twice. She was married to Roy Neal Moore III⁵⁹⁹ and Steve H Fowler⁶⁵⁵.

[See also: *Indirectly Related via Sharon Moore [Mitchell]*]

Roy Neal Moore III⁵⁹⁹, aged 43, married Sharon Moore [Mitchell], aged 42, on 5 April 2003.

602. MICHAEL ALLEN MOORE (Karen's cousin) was born on 9 May 1962 to Charles Allen Moore⁶¹⁸ and Nancy Carol Moore [Washington]⁶¹⁹.

603. WILLIAM MARTIN "MARTY" MOORE (Karen's cousin) was born on 30 May 1965 to Charles Allen Moore⁶¹⁸ and Nancy Carol Moore [Washington]⁶¹⁹. William became known as "Marty".

604. SHARON ROGERS [PUMROY] (Karen's cousin) was born in January 5 A.D. to Charles R "Chuck" Pumroy⁶²¹ and Edna Pumroy [Wilson]⁶²⁰.
605. BOB ROGERS (Karen's cousin's husband).
Bob Rogers married Sharon Rogers [Pumroy]⁶⁰⁴.
606. GREGORY WAYNE PUMROY (Karen's cousin) was born on 30 April 1955 to Charles R "Chuck" Pumroy⁶²¹ and Edna Pumroy [Wilson]⁶²⁰. He died on 23 June 2008, aged 53. He was buried in Cremated.
607. ANGELA GOFFREDO [PUMROY] (Karen's cousin) was born in 1958 to Charles R "Chuck" Pumroy⁶²¹ and Edna Pumroy [Wilson]⁶²⁰.
Angela married three times. She was married to Victor D Goffredo⁶⁰⁸, Barry R Francescangeli⁶⁰⁹ and Richard A Mellor⁶¹⁰.
608. VICTOR D GOFFREDO (Karen's cousin's husband) was born in 1958.
Victor D Goffredo married Angela Goffredo [Pumroy]⁶⁰⁷.
609. BARRY R FRANCESCANGELI (Karen's cousin's husband) was born in 1960.
Barry R Francescangeli married Angela Goffredo [Pumroy]⁶⁰⁷. They had one daughter:
Taylor Francescangeli⁵⁹³ in 1995
610. RICHARD A MELLOR (Karen's cousin's husband) was born in 1959.
Richard A Mellor married Angela Goffredo [Pumroy]⁶⁰⁷. They had one daughter:
Rachel Tiffany Mellor⁵⁹⁴ in 1980
611. WILLIAM EDWARD "BILLY" WILSON JR. (Karen's cousin) was born in 1961 to William Edward "Billy" Wilson Sr.⁶²² and Joan Wilson [Brown]⁶²³. William became known as "Billy".
612. FRANCES WILSON [HAWES] (Karen's cousin's wife) was born on 22 October 1968.
William Edward "Billy" Wilson Jr.⁶¹¹ married Frances Wilson [Hawes]. They had one son:
William Edward "Will" Wilson III⁵⁹⁵ in 1995
613. PATRICK "BRIAN" WILSON (Karen's cousin) was born on 29 March 1970 to William Edward "Billy" Wilson Sr.⁶²² and Joan Wilson [Brown]⁶²³. Patrick became known as "Brian".
614. AMBER WILSON [POWELL] (Karen's cousin's wife) was born on 10 June 1977.
Amber married twice. She was married to Patrick "Brian" Wilson⁶¹³ and Joseph Francis "Joey" Brennan Jr.⁶⁵⁷.
[See also: *Indirectly Related via Amber Wilson [Powell]*]
Patrick "Brian" Wilson⁶¹³, aged 33, married Amber Wilson [Powell], aged 26, on 4 July 2003. They had one daughter:
Ripley Wilson⁵⁹⁶

Generation of Davis' Parents

615. ROY NEAL MOORE JR. (Karen's father) was born on 1 March 1932 to Roy Neal Moore⁶²⁵ and Mamie Ethel Moore [Durham]⁶²⁶. He died (Congested heart failure) on 11 March 2023, aged 91, in Roy Neal Moore III home in Wake County NC. He was buried in Cremated.
Roy married twice. He was married to Betty Jean "BJ" Moore [Wilson]⁶¹⁶ and Lora Ann Moore [Gray]⁶¹⁷.
616. BETTY JEAN "BJ" MOORE [WILSON] (Karen's mother) was born on 15 April 1935, in At home in Magnolia, NC, to William Wells Wilson⁶²⁷ and Effie Ray Wilson [Quinn]⁶²⁸. Betty became known as "BJ". She died (Lung Cancer) on 24 February 2019, aged 83, in At home in Raleigh, NC. She was buried in Cremated.
Roy Neal Moore Jr.⁶¹⁵, aged 26, married Betty Jean "BJ" Moore [Wilson], aged 23, on 6 June 1958 in Ernest Myatt Presbyterian Church, Raleigh, North Carolina, and they were divorced. They had two children:
Roy Neal Moore III⁵⁹⁹ in 1959
Karen Denise Woodall [Moore]⁵² in 1963
617. LORA ANN MOORE [GRAY] (Karen's father's wife) was born on 19 May 1939, in Littleton, North Carolina. She died (Kidney Failure) on 10 May 2016, aged 76. She was buried in Oakwood Cementary, Raleigh, North Carolina.
Roy Neal Moore Jr.⁶¹⁵ married Lora Ann Moore [Gray]. They had one son:
Steven Neal Moore⁵⁹⁷
618. CHARLES ALLEN MOORE (Karen's uncle) was born on 9 July 1936, in Raleigh, North Carolina, to Roy Neal Moore⁶²⁵ and Mamie Ethel Moore [Durham]⁶²⁶. He died on 15 March 2017, aged 80, in Carteret Health Care Morehead City, North Carolina.
619. NANCY CAROL MOORE [WASHINGTON] (Karen's aunt by marriage) was born on 26 May 1936. She died (Congested Heart Failure) on 8 October 2021, aged 85, in Carteret Health Care, Morehead City, NC. She was buried in Cremated.
Charles Allen Moore⁶¹⁸, aged 24, married Nancy Carol Moore [Washington], aged 24, on 4 September 1960. They had two sons:
Michael Allen Moore⁶⁰² in 1962
William Martin "Marty" Moore⁶⁰³ in 1965

620. EDNA PUMROY [WILSON] (Karen's aunt) was born on 25 October 1932 to William Wells Wilson⁶²⁷ and Effie Ray Wilson [Quinn]⁶²⁸.
621. CHARLES R "CHUCK" PUMROY (Karen's uncle by marriage) was born on 6 May 1931. Charles became known as "Chuck". He died on 24 April 2013, aged 81. He was buried in Washington Crossing National Cemetary Newtown, Bucks County, Pennsylvania.
Charles R "Chuck" Pumroy married Edna Pumroy [Wilson]⁶²⁰. They had three children:
Sharon Rogers [Pumroy]⁶⁰⁴ in 5 A.D.
Gregory Wayne Pumroy⁶⁰⁶ in 1955
Angela Goffredo [Pumroy]⁶⁰⁷ in 1958
622. WILLIAM EDWARD "BILLY" WILSON SR. (Karen's uncle) was born on 2 September 1939 to William Wells Wilson⁶²⁷ and Effie Ray Wilson [Quinn]⁶²⁸. William became known as "Billy". He died (Lung Cancer) on 6 December 2007, aged 68, in Kitty Askins Hospice Center in Goldsboro, NC. He was buried in Rose Hill Cemetery.
623. JOAN WILSON [BROWN] (Karen's aunt by marriage) was born on 24 June 1942. She died on 12 December 1997, aged 55. She was buried in Rose Hill Cemetery.
William Edward "Billy" Wilson Sr.⁶²² married Joan Wilson [Brown]. They had two sons:
William Edward "Billy" Wilson Jr.⁶¹¹ in 1961
Patrick "Brian" Wilson⁶¹³ in 1970
624. JOHNNY LOCKERMAN (Karen's uncle) was born to Mr. Lockerman⁶²⁹ and Effie Ray Wilson [Quinn]⁶²⁸.

Generation of Davis' Grandparents

625. ROY NEAL MOORE (Karen's grandfather) was born on 31 October 1897 to Neal Henry Moore⁶³⁰ and Sophony Emery Moore⁶³¹. He died on 24 December 1987, aged 90. He was buried in Montlawn Memorial Park, Raleigh, North Carolina.
626. MAMIE ETHEL MOORE [DURHAM] (Karen's grandmother) was born on 7 October 1899 to Issac R Durham⁶³² and Caroline F Durham⁶³³. She died on 7 July 1959, aged 59. She was buried in Montlawn Memorial Park, Raleigh, North Carolina.
Roy Neal Moore⁶²⁵ married Mamie Ethel Moore [Durham]. They had two sons:
Roy Neal Moore Jr.⁶¹⁵ in 1932
Charles Allen Moore⁶¹⁸ in 1936
627. WILLIAM WELLS WILSON (Karen's grandfather) was born on 30 June 1906 to Cecil Ripton Wilson⁶³⁴ and Rebecca Mathis Wilson⁶³⁵. He died on 26 May 1939, aged 32.
628. EFFIE RAY WILSON [QUINN] (Karen's grandmother) was born on 5 July 1911 to John Henry Quinn⁶³⁶ and Rachel Stroud Quinn⁶³⁷. She died on 30 August 1978, aged 67.
Effie married twice. She was married to William Wells Wilson⁶²⁷ and Mr. Lockerman⁶²⁹.
William Wells Wilson⁶²⁷ married Effie Ray Wilson [Quinn]. They had three children:
Edna Pumroy [Wilson]⁶²⁰ in 1932
Betty Jean "BJ" Moore [Wilson]⁶¹⁶ in 1935
William Edward "Billy" Wilson Sr.⁶²² in 1939
629. MR. LOCKERMAN (Karen's grandmother's husband). He is no longer living.
Mr. Lockerman married Effie Ray Wilson [Quinn]⁶²⁸. They had one son:
Johnny Lockerman⁶²⁴

Generation of Davis' Great-Grandparents

630. NEAL HENRY MOORE (Karen's great-grandfather) was born in 1872, in Rocky Mount, North Carolina, to William Moore⁶³⁸ and Mary Moore⁶³⁹. He died in Raleigh, North Carolina.
631. SOPHONY EMERY MOORE (Karen's great-grandmother) was born in 1876 to William Emory⁶⁴⁰ and Laura Emory⁶⁴¹. She is no longer living.
Neal Henry Moore⁶³⁰, aged about 19, married Sophony Emery Moore, aged about 15, in 1891. They had one son:
Roy Neal Moore⁶²⁵ in 1897
632. ISSAC R DURHAM (Karen's great-grandfather) was born on 7 March 1843. He died on 22 September 1911, aged 68, in Garner, North Carolina.
633. CAROLINE F DURHAM (Karen's great-grandmother) was born on 24 August 1854. She died on 18 November 1926, aged 72, in Garner, North Carolina.

Issac R Durham⁶³² married Caroline F Durham. They had one daughter:
Mamie Ethel Moore [Durham]⁶²⁶ in 1899

634. CECIL RIPTON WILSON (Karen's great-grandfather) was born on 16 October 1873 to William Wright Wilson⁶⁴² and Fannie Wilson [Fason]⁶⁴³. He died on 18 July 1957, aged 83.
635. REBECCA MATHIS WILSON (Karen's great-grandmother) was born on 26 October 1878 to Wells Mathis⁶⁴⁴ and Julia Mathis [Petterson]⁶⁴⁵. She died on 9 May 1959, aged 80.
Cecil Ripton Wilson⁶³⁴ married Rebecca Mathis Wilson. They had one son:
William Wells Wilson⁶²⁷ in 1906

636. JOHN HENRY QUINN (Karen's great-grandfather) was born on 26 January 1858. He died on 25 November 1919, aged 61.
637. RACHEL STROUD QUINN (Karen's great-grandmother) was born on 1 April 1877. She died on 18 October 1950, aged 73.
John Henry Quinn⁶³⁶ married Rachel Stroud Quinn. They had one daughter:
Effie Ray Wilson [Quinn]⁶²⁸ in 1911

Generation of Davis' Great-Great-Grandparents

638. WILLIAM MOORE (Karen's great-great-grandfather) was born in 1847. He is no longer living.
639. MARY MOORE (Karen's great-great-grandmother). She is no longer living.
William Moore⁶³⁸ married Mary Moore. They had one son:
Neal Henry Moore⁶³⁰ in 1872
640. WILLIAM EMORY (Karen's great-great-grandfather) was born on 23 March 1844, in Houses Creek, Wake County, North Carolina, to Ephraim Emery⁶⁴⁶ and Margaret Emery⁶⁴⁷. He is no longer living.
641. LAURA EMORY (Karen's great-great-grandmother) was born in 1847. She is no longer living.
William Emory⁶⁴⁰ married Laura Emory. They had one daughter:
Sophony Emery Moore⁶³¹ in 1876
642. WILLIAM WRIGHT WILSON (Karen's great-great-grandfather) was born in 1844. He is no longer living.
643. FANNIE WILSON [FASON] (Karen's great-great-grandmother).
William Wright Wilson⁶⁴² married Fannie Wilson [Fason]. They had one son:
Cecil Ripton Wilson⁶³⁴ in 1873
644. WELLS MATHIS (Karen's great-great-grandfather).
645. JULIA MATHIS [PETTERSON] (Karen's great-great-grandmother).
Wells Mathis⁶⁴⁴ married Julia Mathis [Petterson]. They had one daughter:
Rebecca Mathis Wilson⁶³⁵ in 1878

Generation of Davis' Great-Great-Great-Grandparents

646. EPHRAIM EMERY (Karen's great-great-great-grandfather) was born in 1807, in Wake County, North Carolina, to Lewis Emery⁶⁴⁸ and Elizabeth Emery⁶⁴⁹. He is no longer living.
647. MARGARET EMERY (Karen's great-great-great-grandmother) was born in 1817, in North Carolina. She is no longer living.
Ephraim Emery⁶⁴⁶ married Margaret Emery. They had one son:
William Emory⁶⁴⁰ in 1844

Generation of Davis' Four-Times-Great-Grandparents

648. LEWIS EMERY (Karen's four-times-great-grandfather) was born in 1765 to Edmund Emery⁶⁵⁰. He is no longer living.
649. ELIZABETH EMERY (Karen's four-times-great-grandmother) was born in 1785. She is no longer living.
Lewis Emery⁶⁴⁸ married Elizabeth Emery. They had one son:
Ephraim Emery⁶⁴⁶ in 1807

Generation of Davis' Five-Times-Great-Grandparents

650. EDMUND EMERY (Karen's five-times-great-grandfather). He is no longer living.
Edmund fathered one son:
Lewis Emery⁶⁴⁸ in 1765

6. INDIRECTLY RELATED via SHARON MOORE [MITCHELL] ⁶⁰¹
(Karen Denise Woodall [Moore]'s sister-in-law)

Generation of Davis' Grandchildren

651. COOPER STEVEN JOHNSON (Sharon's grandson) was born on 21 December 2013 to Michael Johnson⁶⁵⁴ and Nicole Johnson [Fowler]⁶⁵³.
652. CASSIDY NICOLE JOHNSON (Sharon's granddaughter) was born on 26 June 2016 to Michael Johnson⁶⁵⁴ and Nicole Johnson [Fowler]⁶⁵³.

Generation of Davis' Children

653. NICOLE JOHNSON [FOWLER] (Sharon's daughter) was born on 13 January 1988 to Steve H Fowler⁶⁵⁵ and Sharon Moore [Mitchell]⁶⁰¹.
654. MICHAEL JOHNSON (Sharon's son-in-law) was born on 15 June 1988.
Michael Johnson, aged 23, married Nicole Johnson [Fowler]⁶⁵³, aged 24, on 14 April 2012. They had two children:
Cooper Steven Johnson⁶⁵¹ in 2013
Cassidy Nicole Johnson⁶⁵² in 2016

Generation of Davis's Peers

655. STEVE H FOWLER (Sharon's husband) was born on 13 May 1960. He died on 6 March 2000, aged 39. He was buried in Montlawn Memorial Park, Raleigh, Wake Co, NC.
Steve H Fowler married Sharon Moore [Mitchell]⁶⁰¹. They had one daughter:
Nicole Johnson [Fowler]⁶⁵³ in 1988

7. INDIRECTLY RELATED via AMBER WILSON [POWELL] ⁶¹⁴
(Karen Denise Woodall [Moore]'s cousin's wife)

Generation of Davis' Children

656. CHRISTIAN "TANNER" BRENNAN (Amber's son) was born in 1995 to Joseph Francis "Joey" Brennan Jr. ⁶⁵⁷ and Amber Wilson [Powell] ⁶¹⁴. Christian became known as "Tanner".

Generation of Davis's Peers

657. JOSEPH FRANCIS "JOEY" BRENNAN JR. (Amber's husband) was born in 1972. Joseph became known as "Joey".
Joseph Francis "Joey" Brennan Jr. married Amber Wilson [Powell] ⁶¹⁴. They had one son:
Christian "Tanner" Brennan ⁶⁵⁶ in 1995

8. INDIRECTLY RELATED via BILL ULYSSES DAVIS¹¹⁴

(Davis' uncle by marriage)

Generation of Davis' Grandparents

658. GENERAL WILLIAM "WILL" DAVIS (Bill's father). General became known as "Will". He is no longer living.

659. ILA MAE DAVIS [TALTON] (Bill's mother). She is no longer living.

General William "Will" Davis⁶⁵⁸ married Ila Mae Davis [Talton]. They had one son:

Bill Ulysses Davis¹¹⁴ in 1922

9. INDIRECTLY RELATED via BILLIE JEAN DUPREE [STEPHENSON]¹¹⁶

(Davis' aunt by marriage)

Generation of Davis' Children

660. ANGELIQUE SHEETS (Billie's granddaughter) was born to Robert Lynn "Bobby" Sheets⁶⁶¹ and Jerri Sheets⁶⁶².

Generation of Davis's Peers

661. ROBERT LYNN "BOBBY" SHEETS (Billie's son) was born in 1953 to Mr. Sheets⁶⁶³ and Billie Jean Dupree [Stephenson]¹¹⁶. Robert became known as "Bobby". Robert became a Drywall.

Note: *Daddy was a Sheets; born out of wedlock.*

662. JERRI SHEETS (Billie's son's partner).

Robert Lynn "Bobby" Sheets⁶⁶¹ and Jerri Sheets had one daughter:

Angelique Sheets⁶⁶⁰

The following information is also recorded for this family. Friends.

Generation of Davis' Parents

663. MR. SHEETS (Billie's partner).

Mr. Sheets and Billie Jean Dupree [Stephenson]¹¹⁶ had one son:

Robert Lynn "Bobby" Sheets⁶⁶¹ in 1953

The following information is also recorded for this family. Unknown Relationship.

10. INDIRECTLY RELATED via RACHAEL JANE DUPREE [HONEYCUTT] ¹²⁰

(Davis' aunt by marriage)

Generation of Davis' Peers

664. SCOTT BARBOUR (Rachael's son) was born to George Halford Barbour⁶⁶⁸ and Rachael Jane Dupree [Honeycutt]¹²⁰.

665. SHEA BARBOUR (Rachael's daughter-in-law).

Scott Barbour⁶⁶⁴ married Shea Barbour.

666. KEVIN BARBOUR (Rachael's son) was born to George Halford Barbour⁶⁶⁸ and Rachael Jane Dupree [Honeycutt]¹²⁰.

667. TRACIE BARBOUR (Rachael's daughter-in-law).

Kevin Barbour⁶⁶⁶ married Tracie Barbour.

Generation of Davis' Parents

668. GEORGE HALFORD BARBOUR (Rachael's husband). He died on 2 January 1983.

George Halford Barbour married Rachael Jane Dupree [Honeycutt]¹²⁰. They had two sons:

Scott Barbour⁶⁶⁴

Kevin Barbour⁶⁶⁶

The following information is also recorded for this family. Widowed.

11. INDIRECTLY RELATED via SHOTZI BUTTS [BUIE] ⁵⁶
(Davis' cousin's wife)

Generation of Davis' Children

669. CANDIE BUIE (Shotzi's daughter) was born to Mr. Buie⁶⁷¹ and Shotzi Butts [Buie]⁵⁶.

670. CHRISSY BUIE (Shotzi's daughter) was born to Mr. Buie⁶⁷¹ and Shotzi Butts [Buie]⁵⁶.

Generation of Davis's Peers

671. MR. BUIE (Shotzi's husband).

Mr. Buie married Shotzi Butts [Buie]⁵⁶. They had two daughters:

Candie Buie⁶⁶⁹

Chrissy Buie⁶⁷⁰

12. INDIRECTLY RELATED via JANET LYNNE FRANKS [SWIGER] ¹⁷⁸

(Davis' second cousin's wife, once removed)

Generation of Davis's Peers

672. ASLEY SWIGER JARVIS [ROSE] (Janet's daughter) was born in 1984 to Jonathan Lemoyne Rose⁶⁷³ and Janet Lynne Franks [Swiger]¹⁷⁸.

Generation of Davis' Parents

673. JONATHAN LEMOYNE ROSE (Janet's husband) was born on 29 July 1954. He died on 19 October 2005, aged 51. Jonathan Lemoyne Rose married Janet Lynne Franks [Swiger]¹⁷⁸. They had one daughter:
Asley Swiger Jarvis [Rose]⁶⁷² in 1984

13. INDIRECTLY RELATED via ELIZABETH BRETT [LOWE] ⁴⁶³
(Davis' nine-times-great-grandfather's wife)

Generation of Davis' Ten-Times-Great-Grandparents

674. JOHN LOWE JR. (Elizabeth's father). He is no longer living.
John fathered one daughter:
Elizabeth Brett [Lowe] ⁴⁶³ about 1628

14. FAMILY TREES

Each family tree shows the reported children, parents, grandparents and great-grandparents of a family group. In order to reduce redundancy, any family group which is wholly included within another family tree may not be reported separately.

Above each of the great-grandparent boxes (top row), a continuation family tree reference number is shown if the great-grandparent is recorded as a child in the continuation tree. A continuation reference number is also shown to the left of a grandparent or parent box if that individual has siblings reported in the continuation tree; and beneath a child box (bottom row) if that individual has children reported in the continuation tree.

In cases of multiple marriages, a continuation reference number preceded by "=" is shown to the right of a parent box. This number references the previous and/or next tree in which that individual is shown with another partner.

In cases of adopted (or fostered) children, the parental connection is shown with a dashed line and a continuation reference number preceded by "-" is shown within the individual's box. This number references the tree in which that individual is shown with his or her natural parents.

1. WOODALL, Bryant Lee and WOODALL [MORGAN], Jesse Marie
2. WOODALL, Cody Davis and WOODALL [WILDER], Christine Denise
3. WOODALL, Davis Bryant "Dave", Jr. and WOODALL [MOORE], Karen Denise
4. WOODALL, Davis Bryant and WOODALL [DUPREE], Betty Sue
5. WOODALL, Gilbert Chesley and WOODALL [BRITT], Alda Leland
6. DUPREE, John Stuart and DUPREE [FRANKS], Ruby Larry
7. WOODALL, Edward Hale and WOODALL [LEE], Sarah
8. BRITT, Leonard Lethco and BRITT [GUY], Mary Francis
9. DUPREE, Charlie Benton and DUPREE [YOUNG], Martha Caroline
10. FRANKS, Robert Larry and FRANKS [MARSHBURN], Vienna Jannetta
11. WOODALL, Burt A and WOODALL [WELLONS], Eliza
12. LEE, Ransom and LEE [ROSE], Lucy E
13. BRITT, Joseph Leonard and BRITT [YOUNG], Edith Rebecca
14. DUPREE, James G and DUPREE [ADAMS], Julia Ann
15. FRANKS, William Nathaniel "Nat" and FRANKS [PERRY], Lorenda Arinda "Lora"
16. MARSHBURN, Dr Berry Daniel and MARSHBURN [PARKER], Susan Alice
17. WOODALL, James Gower and WOODALL [BARBER], Sarah "Sally"
18. LEE, Henry "Harry" and LEE [COATS], Sally
19. BRITT, Hardy and BRITT [PENNY], Charlotte
20. DUPREE, Thomas Jefferson and DUPREE [GREGORY], Allie Oliver
21. FRANKS, James "Jim" David and FRANKS [JONES], Emma Gasten
22. MARSHBURN, William and MARSHBURN [ELLIS], Susan
23. WOODALL, Jacob B. and WOODALL [GOWER], Lucy Phereby
24. LEE, Lemuel Samuel "Lom" and LEE [RAINS], Ann
25. BRITT, Joseph, Jr. and BRITT [STEPHENS], Nancy
26. DUPREE, Henry and DUPREE [YOUNG], Kizzie
27. FRANKS, Anthony and FRANKS [HUNTER], Anna
28. JONES, Austin and JONES [LANE], Martha Ann
29. MASHBURN, Pvt Daniel and MASHBURN [WARREN], Delphia
30. WOODALL, Jacob and WOODALL [HICKS], Agnes
31. LEE, Edward G and LEE [ALLEN], Mary
32. BRITT, Joseph and BRITT, Ms.
33. DUPREE, Haley, II and DUPREE [CLARK], Elizabeth Bettie
34. FRANKS, Lewis Henry and FRANKS [FREEMAN], Sarah
35. LANE, Nathaniel M. and LANE [SMITH], Elizabeth
36. MASHBURN, Matthew and MASHBURN, Sarah
37. WOODALL, John Issac and WOODALL [SAMPSON], Judith
38. LEE, Capt. John Esquire and LEE [BRYAN], Mary
39. BRITT, John, Jr. and BRITT [FENNO], Freeloove
40. DUPREE, Haley and DUPREE [GARRIS], Susannah Elizabeth
41. FRANKS, Anthony and FRANKS [COOK], Martha
42. LANE, James and LANE [SPEIGHT], Lydia
43. WOODALL, John and WOODALL [STANLEY], Sarah
44. LEE, Richard Henry and LEE [YOUNG], Mary
45. BRETT, John and BRETT [BARNSDALE (BARNSDELL)], Ann
46. DUPREE, Loys "Louis" and DUPREE [ELLERBEE], Larance Lara

47. FRANKS, Jacob Miller and FRANKS [ASHLEY], Mary Ann
48. MASHBURN, Edward Mashborne, Sr. and MASHBURN [SINDERY], Sarah
49. WOODALL, Dr. John William and WOODALL [HENCHPOLE], Sarah
50. LEE, William and LEE [FELTON], Alice
51. BRETT, John and BRETT [WATERS], Elizabeth
52. DUPREE, Josias "Joseph" Crancie and DUPREE [LAMOREAUX], Mynetta "Mary" Denizot
53. FRANCK, John Martin and FRANCK [TIMMERMAN], Sevil Civil
54. WOODALL, Surgeon General John and WOODALL [STAUELIE], Sara
55. LEE, Colonel Richard Henry and LEE [CONSTABLE], Ann
56. BRETT, Edmund and BRETT [GOSLING], Elizabeth Susan
57. DUPRE, Barthelemy and DUPRE [ROBIN], Matilda
58. FRANCKE, August Hermann and FRANCKE [VON WURMB], Anna Magdalena
59. WOODALL, Richard and WOODALL [ITHELL], Mary
60. LEE, John, Sr. and LEE [HANCOCK], Jane
61. BRITT, Thomas Brett and BRITT [COWARD], Ursula
62. DUPRE, Jean and DUPRE [BESSONET], Margeurite
63. FRANCKE, Johannes and FRANCKE [GLOXIN], Anna
64. LEE, Richard and LEE [BENDEY], Elizabeth
65. BRITT, Randle Brett and BRITT [CHETWYND], Margaret
66. DUPRE, Louis and DUPRE [GONZALES], Elizabeth
67. FRANCKE, Hans Francke and FRANCKE, Ms.
68. LEE, Sir John "John Lee Esquire" and LEE [ROMNEY], Joyce
69. BRETT, Edward and BRETT [FITTON], Cissely
70. DUPRE, Louis Claude, II and DUPRE [MOEZE], Suzanne
71. LEE, Sir Humphrey "Humphrey De Lee" and LEE [BLOUNT], Katherine
72. BRETT, Randolphe and BRETT [WOODE], Ann
73. DUPRE, Louis Claude, I and DUPRE [JOSPIN], Alice
74. LEE, Sir Thomas and LEE [MORTON], Johanna
75. DUPRE, Jaques "James" Henre and DUPRE [GAILLARD], Anonette
76. LEE, Sir Richard "Recardus /De Lee/Lee", Lee" and LEE [SPRENCHEAUX], Margery Sprencieux
77. DUPRE, Jaques Henre, II and DUPRE [VILLIERS], Agnes
78. LEE, Radolphus "Ralph de Lee" and LEE [RIDLEY], Isabella
79. DUPRE, Sir Josias and DUPRE [ESTEVEVES], Lady Maria
80. LEE, Robert "Robert /De Lee/", " and LEE [PIMHALL], Petronella "Petronilla Of Lampley /De Lee/", "
81. DUPRE, Sir Richard and DUPRE [DEVERMONDOIS], Paschale
82. DE LEE, Roger "Robert" and DE LEE [ASTLEY], Margaret "Margaret de Astley"
83. LORD OF PEREINS DU PUY II, Gillies and DU PUY [DE HAUTEVILLE], Lady Marie Florence
84. DE LA LEE, John, II and DE LA LEE, Margaret
85. LORD OF ROCHEFORT DU PUY I, KNIGHT, Gilles and DU PUY [DE BELLECOMBE], Alix
86. DE LA LEE, Sir Thomas and DE LA LEE [CORBET], Petronilla
87. DU PUY V, Lord Alleman and DU PUY [DE ROLAND], Ainarde
88. DE LA LEE, Sir John "John Lee Esquire" and DE LA LEE, Rei Mnu
89. DU PUY IV, Chevalier Alleman and DU PUY [DE LANCOIL], Eleanore Alleman
90. DE LAGA, Reginald "Reginald Reynor de la Lea" and DE LAGA, Rei Lega
91. SGR. OF BORDEAU DU PUY III, Alleman and DU PUY [ARTOD], Beatrix Tournon
92. DE LEGA, Hugo "Hugo de La Lea /de Lee/", " and DE LEGA, Christian De Stainton
93. SEIGNEUR DE PEREINS DU PUY II, Chevalier Alleman de Montbrun and DU PUY, Alix Princess of Dauphine
94. MARCHER LORD OF WHITTINGTON AND ALVESTON FITZWARIN III, Sir Fulk and FITZWARIN [DE BLANCMINISTER WARRINE], Eva
95. APIFER & MONTBRUN DU PUY II , SEIGNEUR DE PEREINS, ROCHEFORT, Chevalier Hugues and DU PUY [DE MORIAN], Floride
96. LORD OF WHITTINGTON AND ALVESTON FITZWARIN II, Fulk II "Brunin" and FITZWARIN [DE DINAN], Hawise
97. DU PUY I, Chevalier Alleman and DU PUY, Lady Veronique Ademar
98. "FULKO" FITZWARIN I, LORD OF WHITTINGTON AND ALDERBURY, "GUARINE DE MEER", Fulk and FITZWARIN [DE WHITTINGTON], Miletta de Whittington
99. LORD OF ROCHEFORT DU PUY I, Hugues and DU PUY, Deurard DE POISIEU
100. DE METZ, Sir Guy Warin "the Bold" and DE METZ [PEVERELL], Baroness Melette Maud ,Heiress of Whittington, "Maud de Ingelrica"
101. DU PUY, Grand Chamberlain Conrad II Raphael (del Poggio) and DE ARCHAIC] DU PUY, COUNTESS OF CONTEVILLE [DE BÉRENGS, Pétronille
102. DE METZ, Warine "The Sherriff" and DE METZ [DE MONTGOMERY], Aimeria Emma de Montgomery

103. DE PODIO, Raymond Guillaume and DE PODIO [DE HEITZ], Amelie
104. DE MONTGOMERY, Gilbert and DE MONTGOMERY [DE VETULIS], Joseline
105. DE PODIO DEL PUECH, Guillaume and DE PODIO DEL PUECH [D'OPFIKON], Berchta
106. I DE MONTGOMERY, Hugh and DE MONTGOMERY [DE NORMANDIE], Joscelina
107. DE PODIO DEL PUECH, Amelius Simplious (de Pugio) and DE PODIO DEL PUECH [D'ARCHINGAUX], Jeanne
108. DE MONTGOMERY, William and DE MONTGOMERY [DE TRIPON], Elizabeth
109. DE PODIO DEL PUECH, Norman Anglo saxony (de Pugio)
110. III DE MONTGOMERY, Roger

1. Bryant Lee Woodall and Jesse Marie Woodall [Morgan]

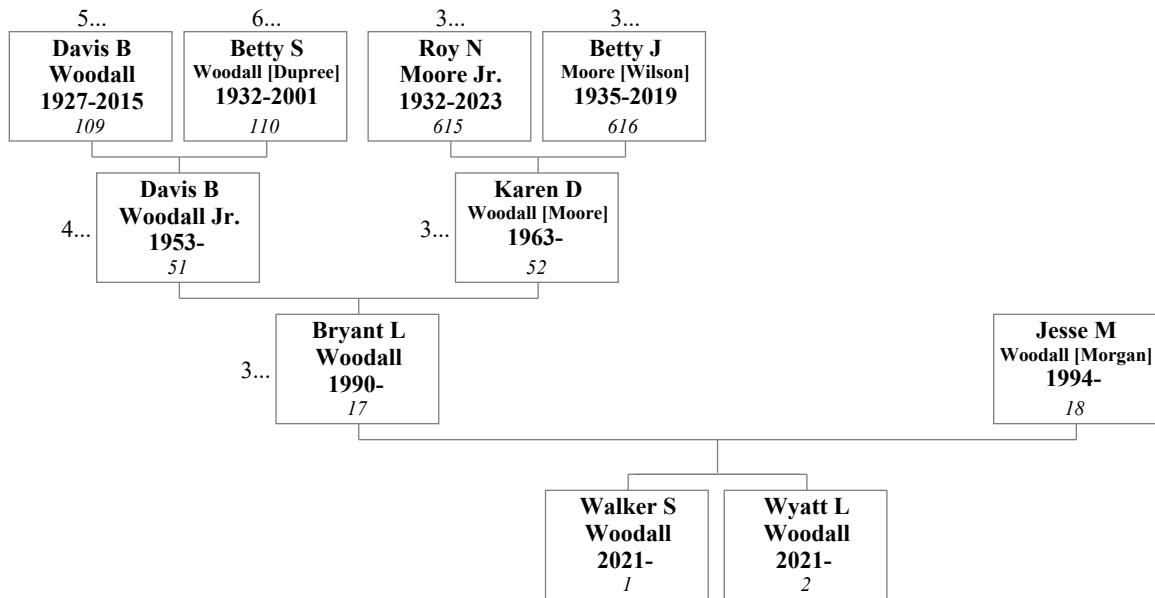

2. Cody Davis Woodall and Christine Denise Woodall [Wilder]

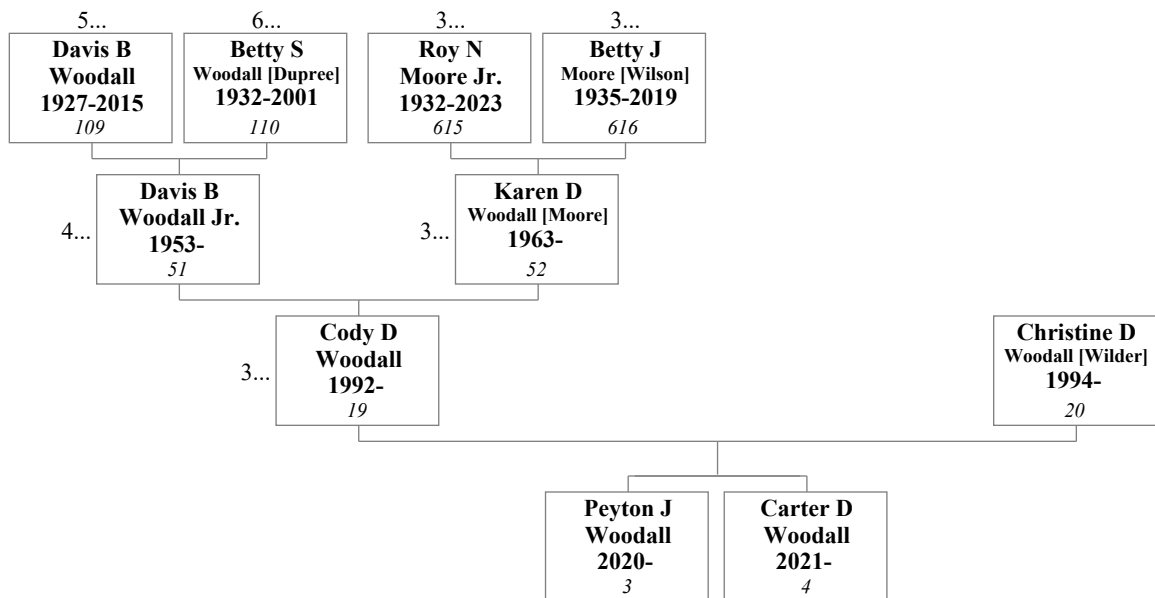

3. Davis Bryant "Dave" Woodall Jr. and Karen Denise Woodall [Moore]

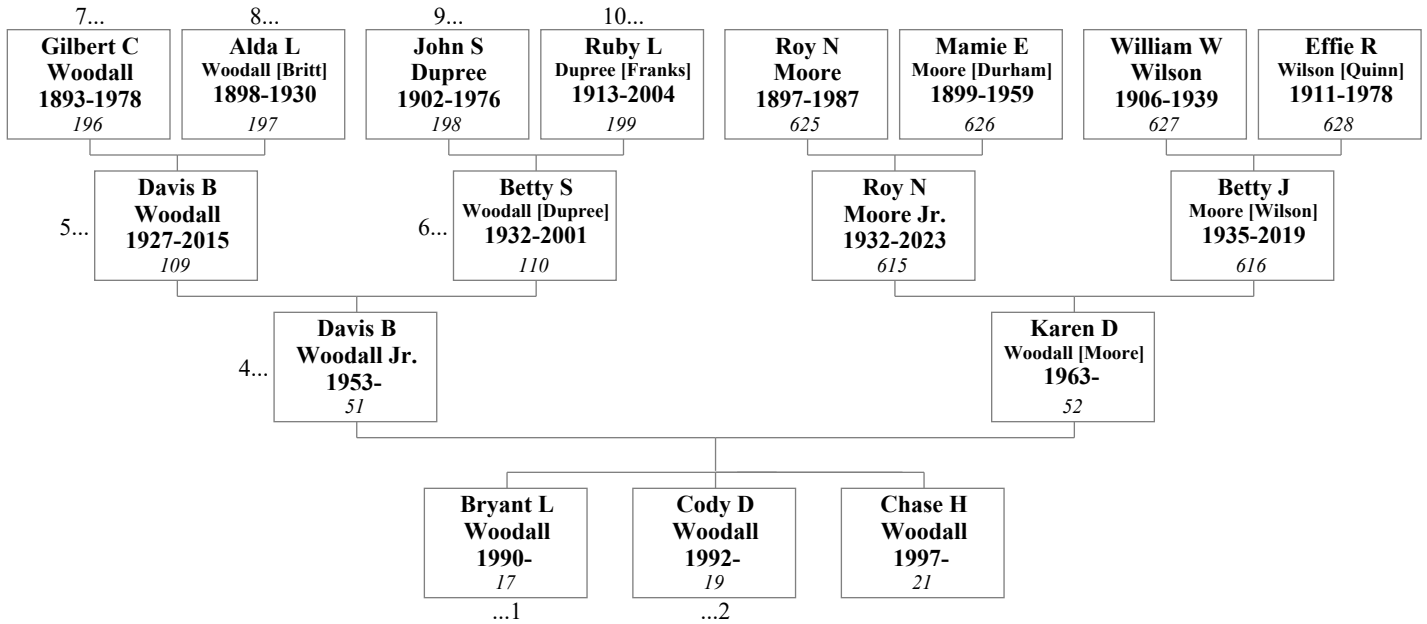

4. Davis Bryant Woodall and Betty Sue Woodall [Dupree]

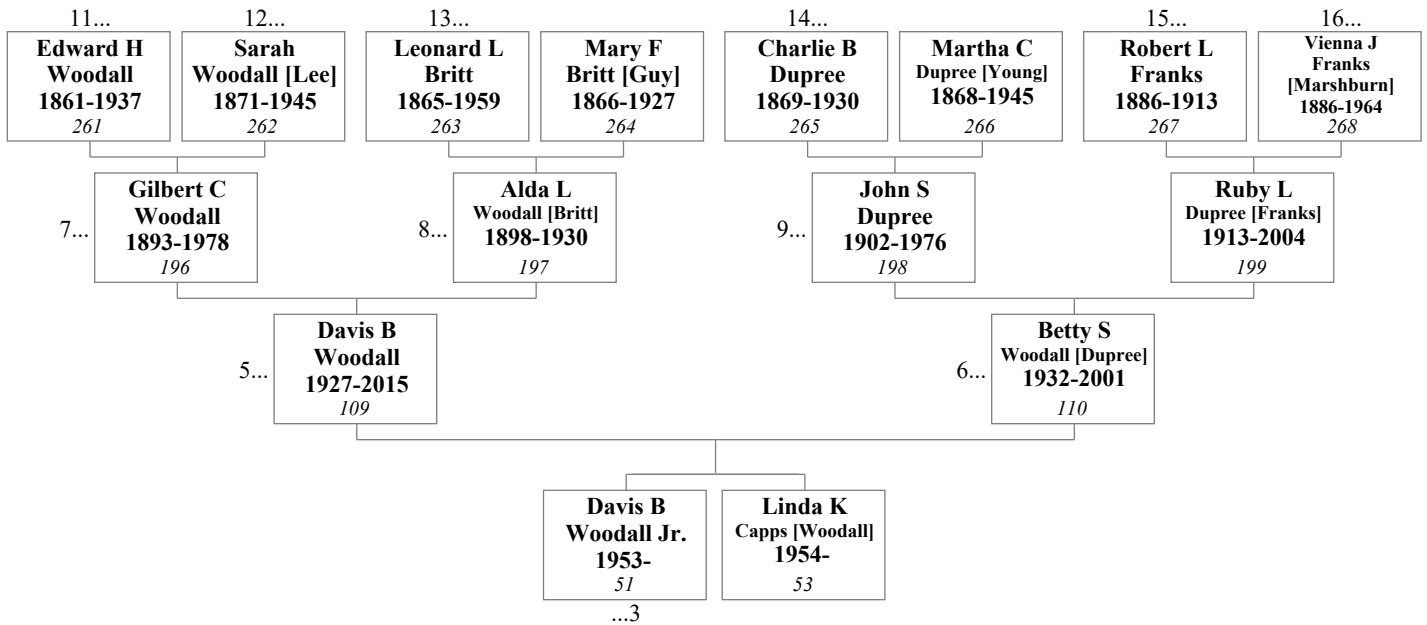

5. Gilbert Chesley Woodall and Alda Leland Woodall [Britt]

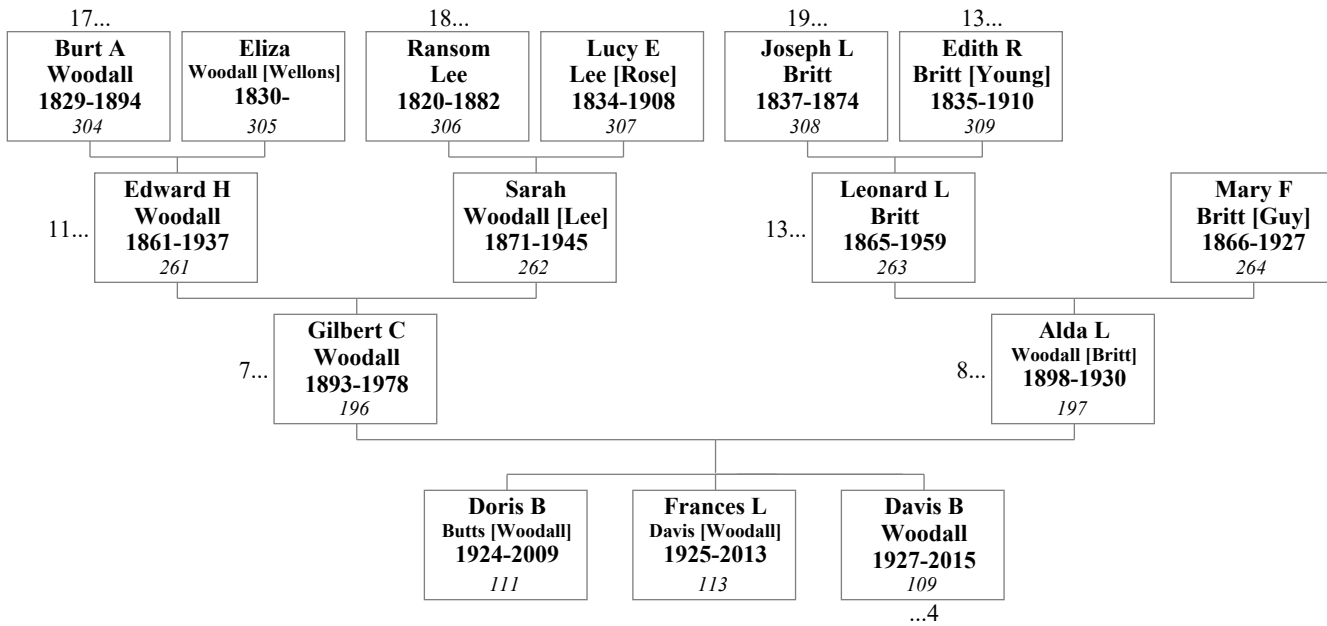

6. John Stuart Dupree and Ruby Larry Dupree [Franks]

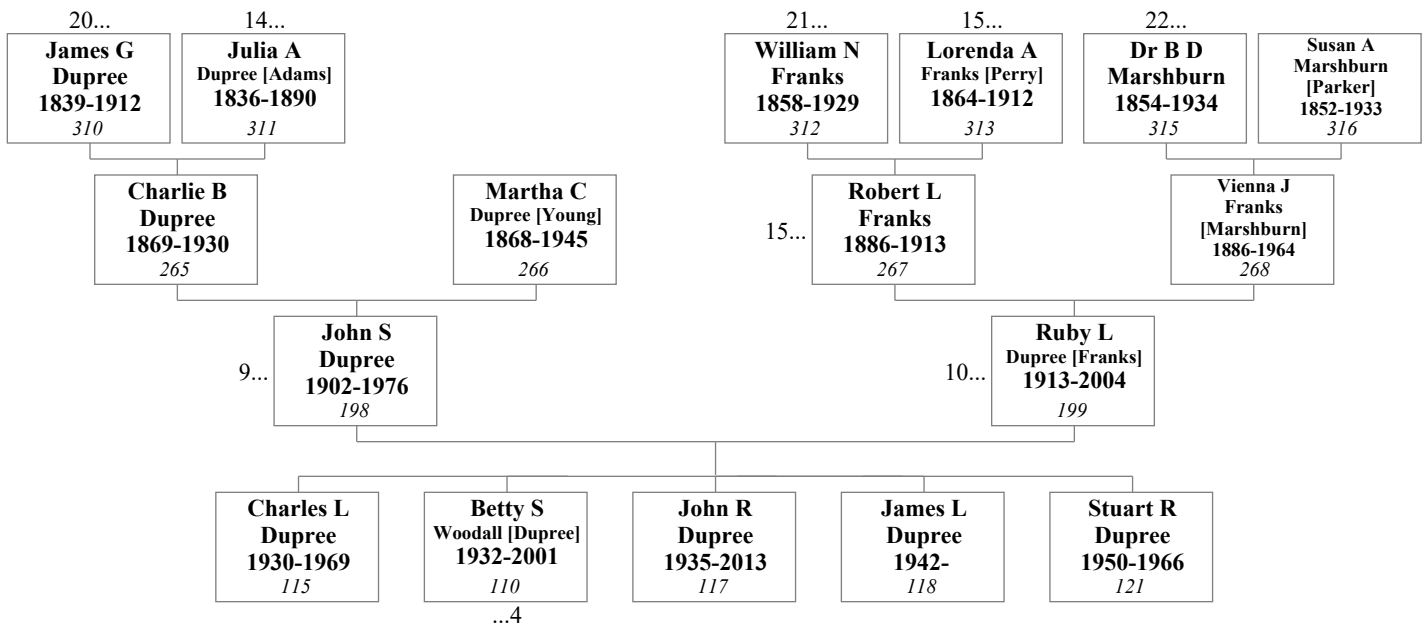

7. Edward Hale Woodall and Sarah Woodall [Lee]

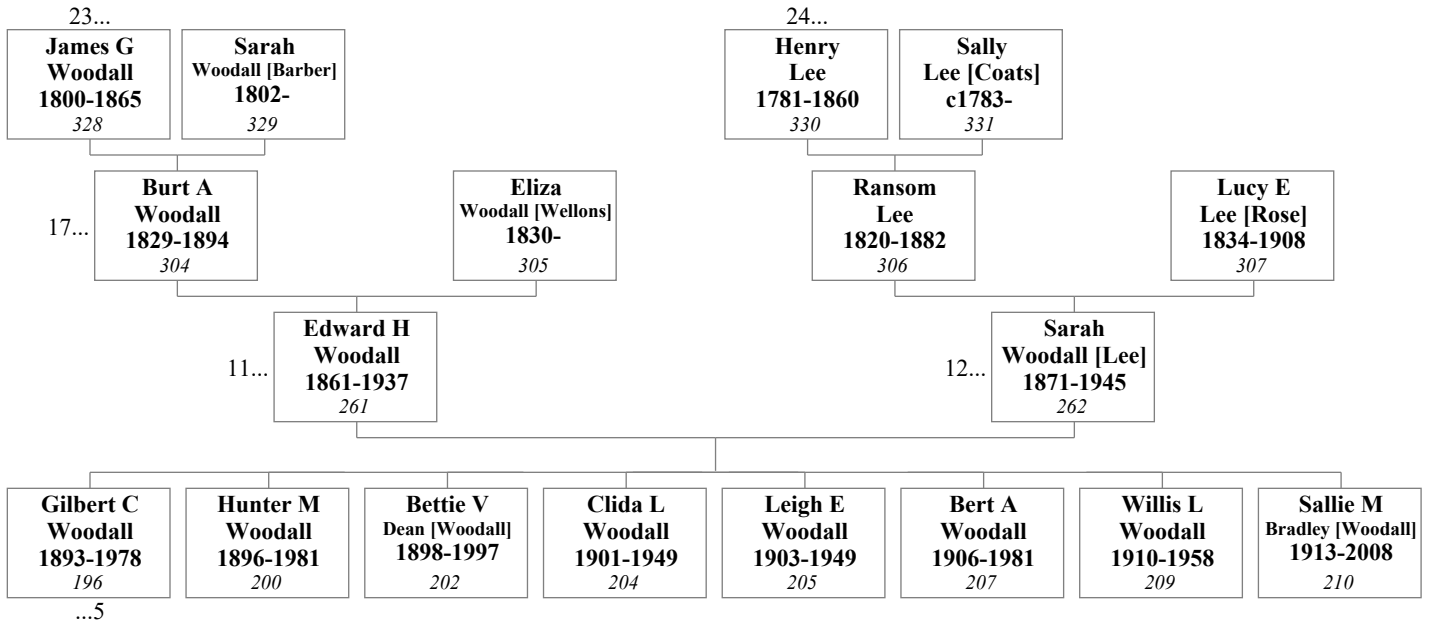

8. Leonard Lethco Britt and Mary Francis Britt [Guy]

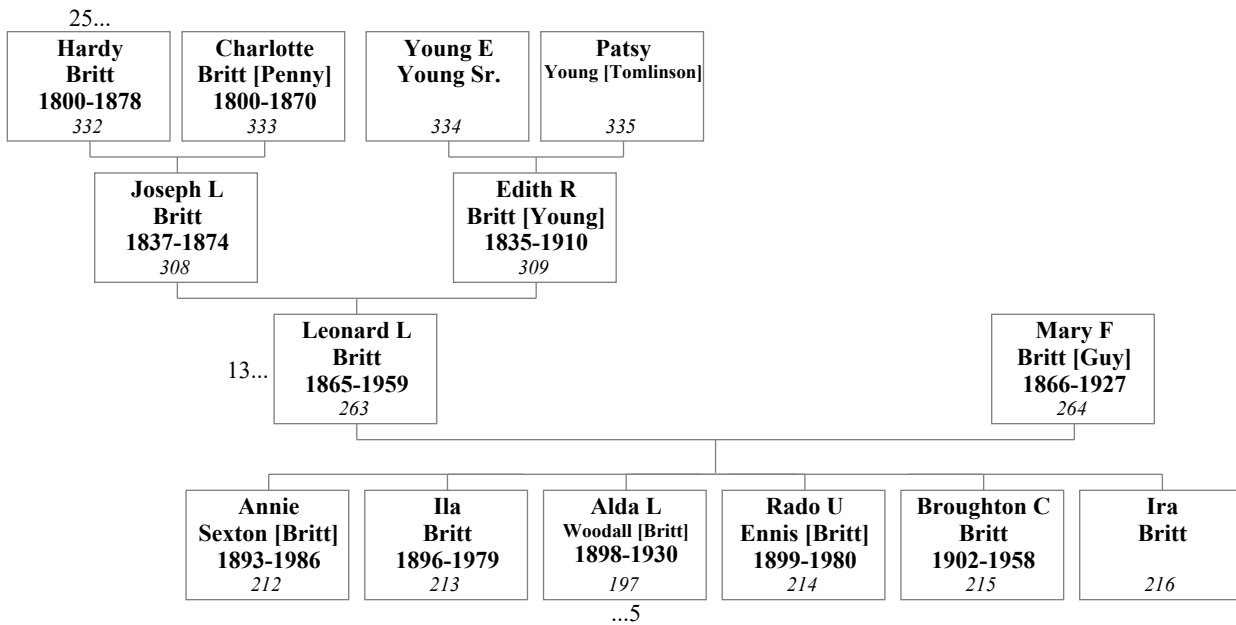

9. Charlie Benton Dupree and Martha Caroline Dupree [Young]

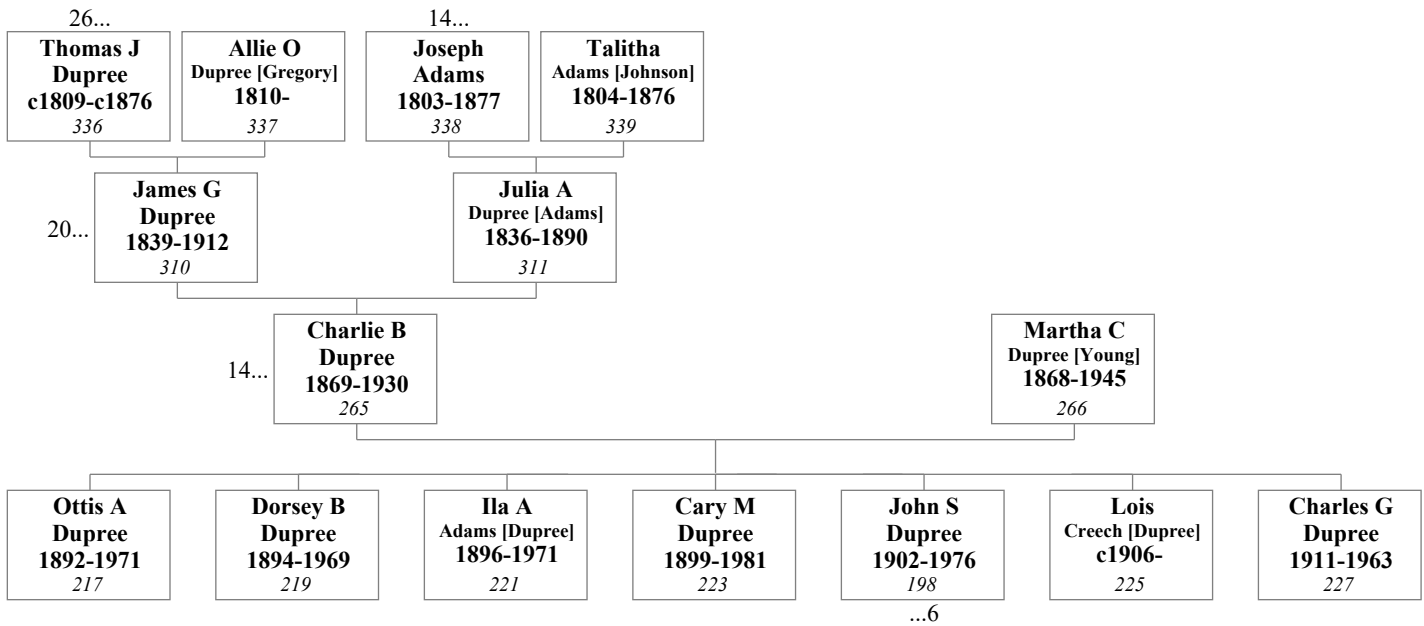

10. Robert Larry Franks and Vienna Jannetta Franks [Marshburn]

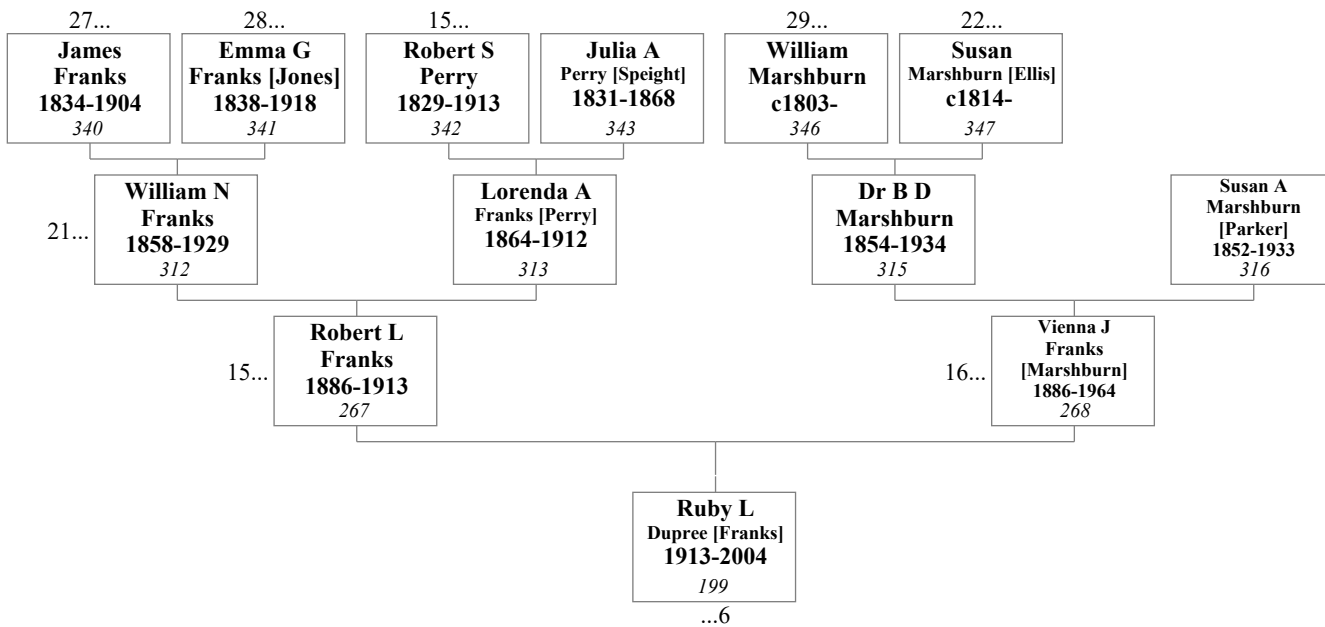

11. Burt A Woodall and Eliza Woodall [Wellons]

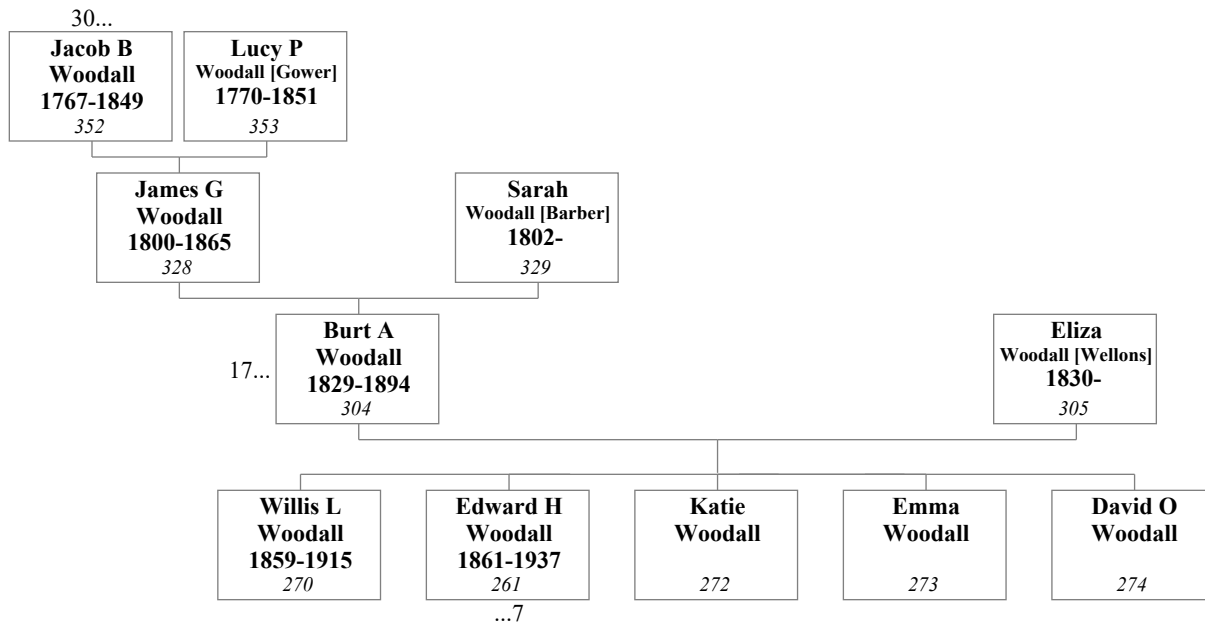

12. Ransom Lee and Lucy E Lee [Rose]

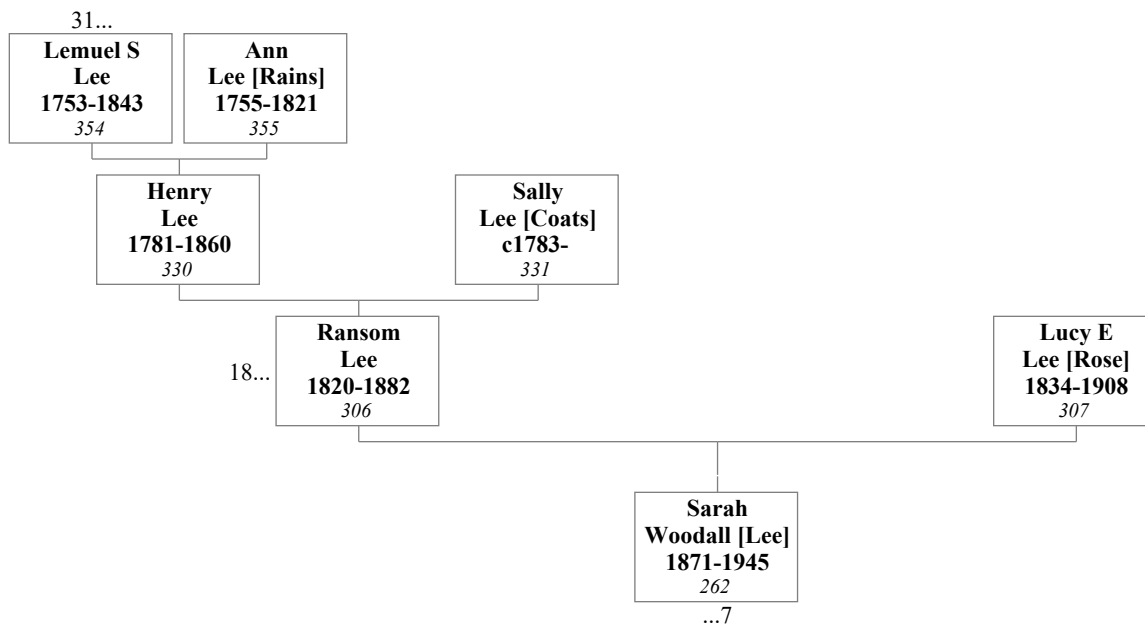

13. Joseph Leonard Britt and Edith Rebecca Britt [Young]

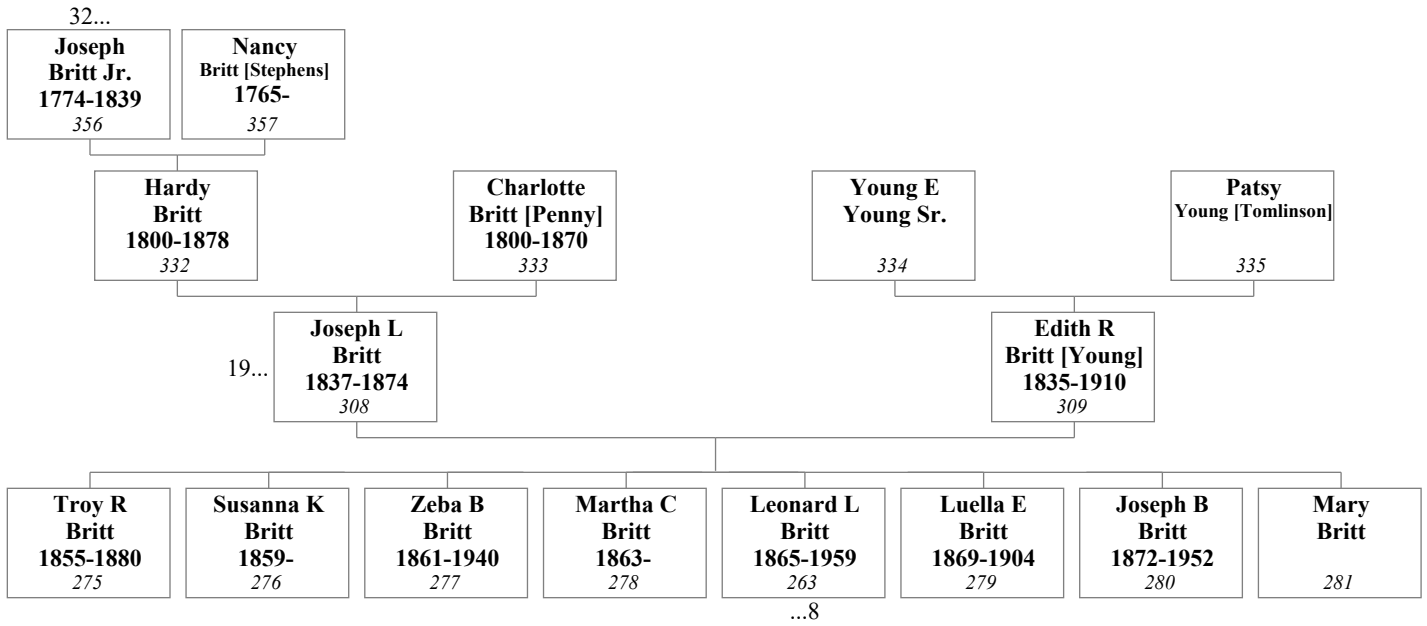

14. James G Dupree and Julia Ann Dupree [Adams]

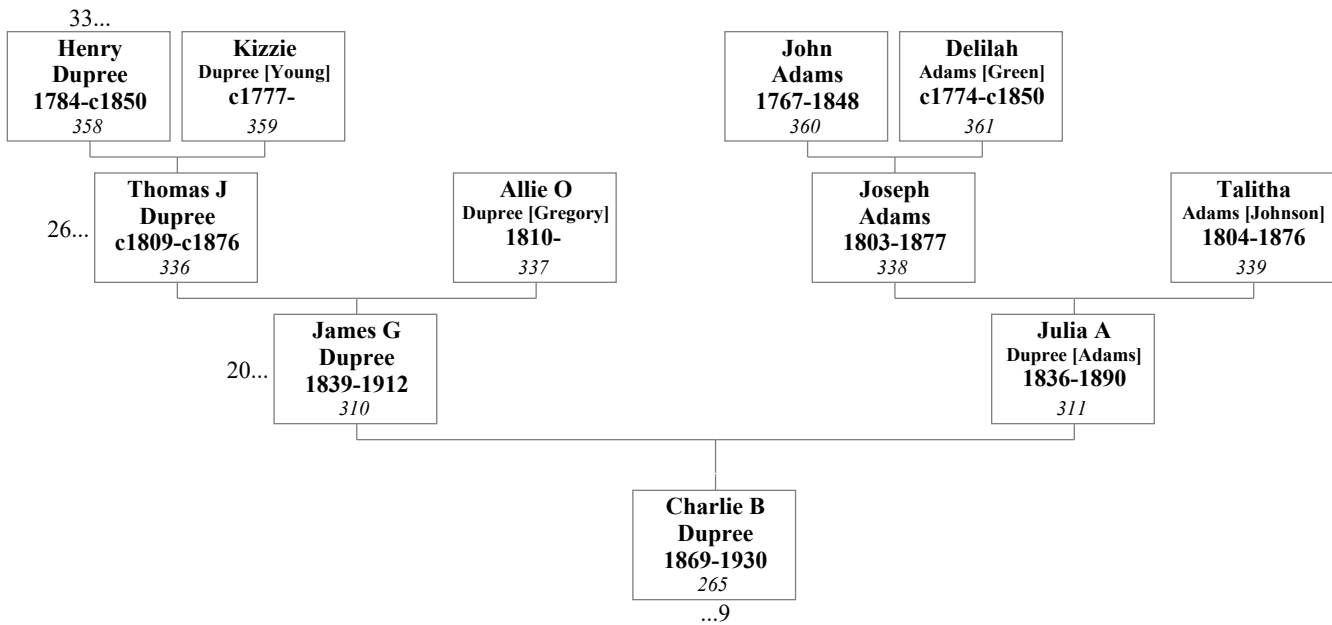

15. William Nathaniel "Nat" Franks and Lorenda Arinda "Lora" Franks [Perry]

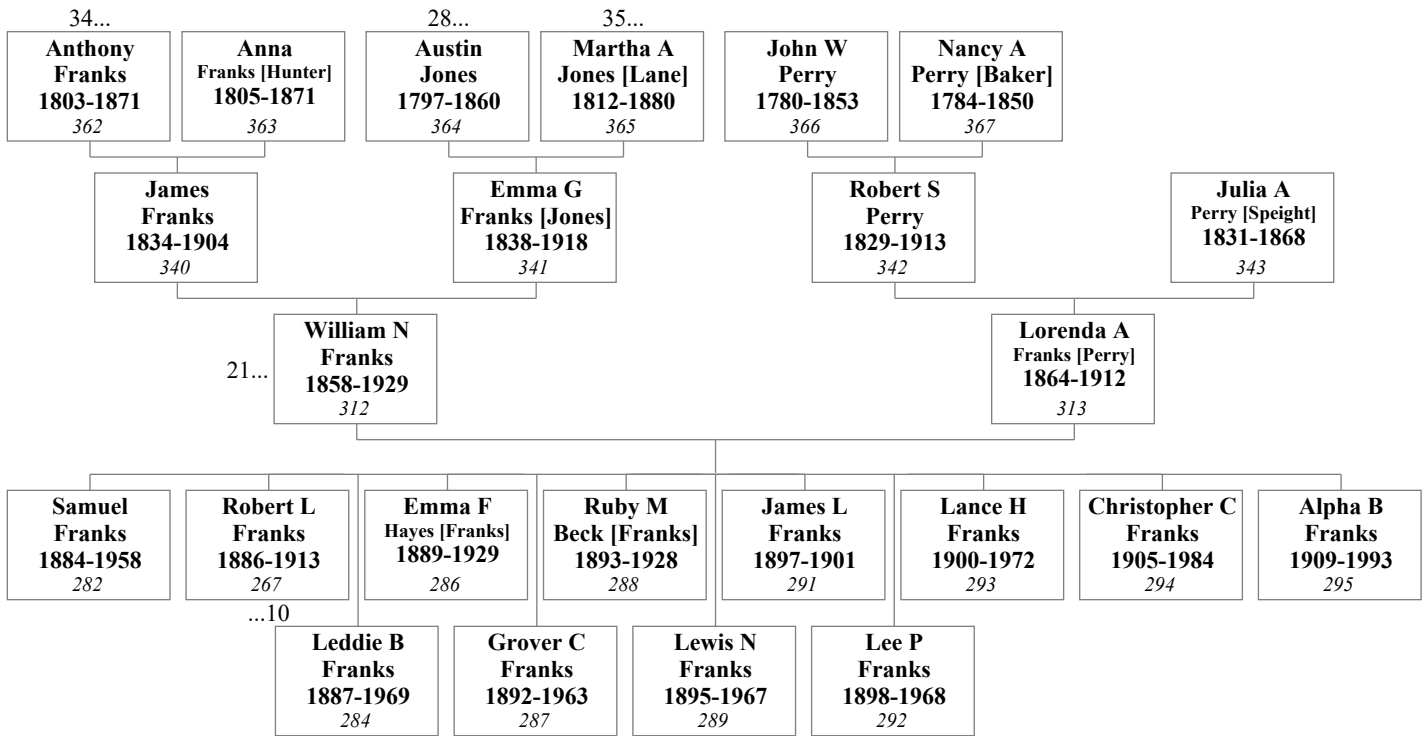

16. Dr Berry Daniel Marshburn and Susan Alice Marshburn [Parker]

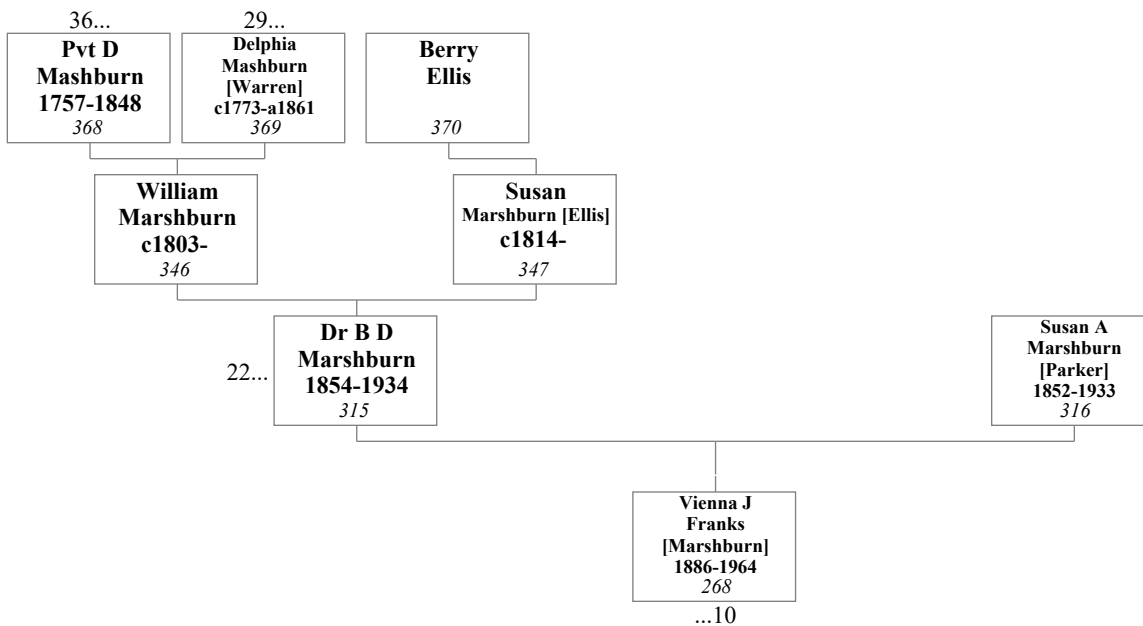

17. James Gower Woodall and Sarah "Sally" Woodall [Barber]

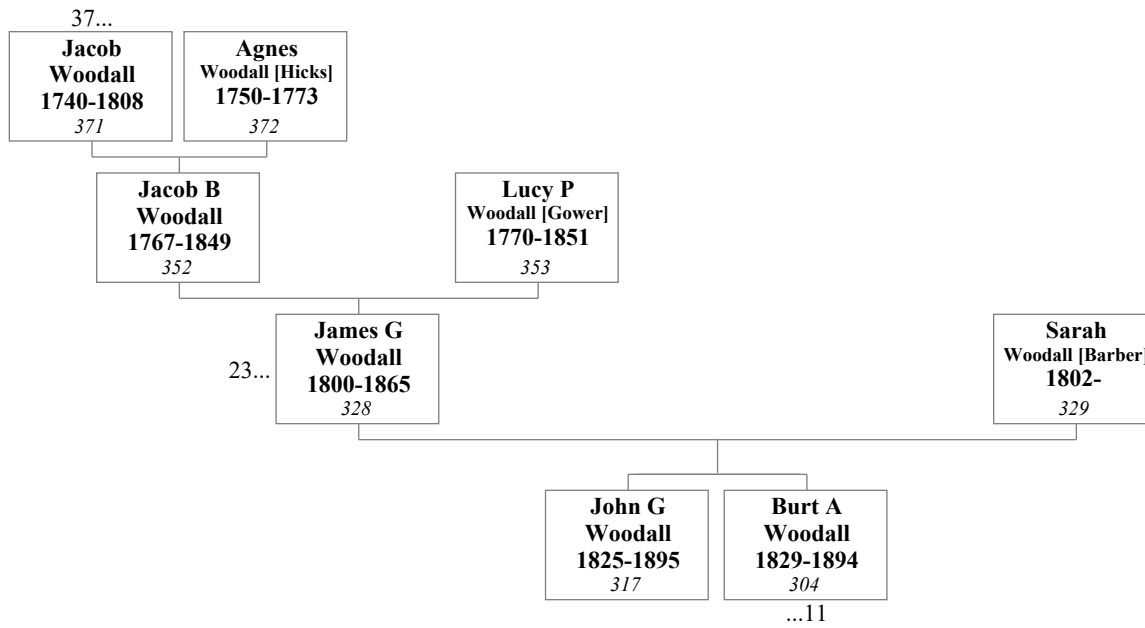

18. Henry "Harry" Lee and Sally Lee [Coats]

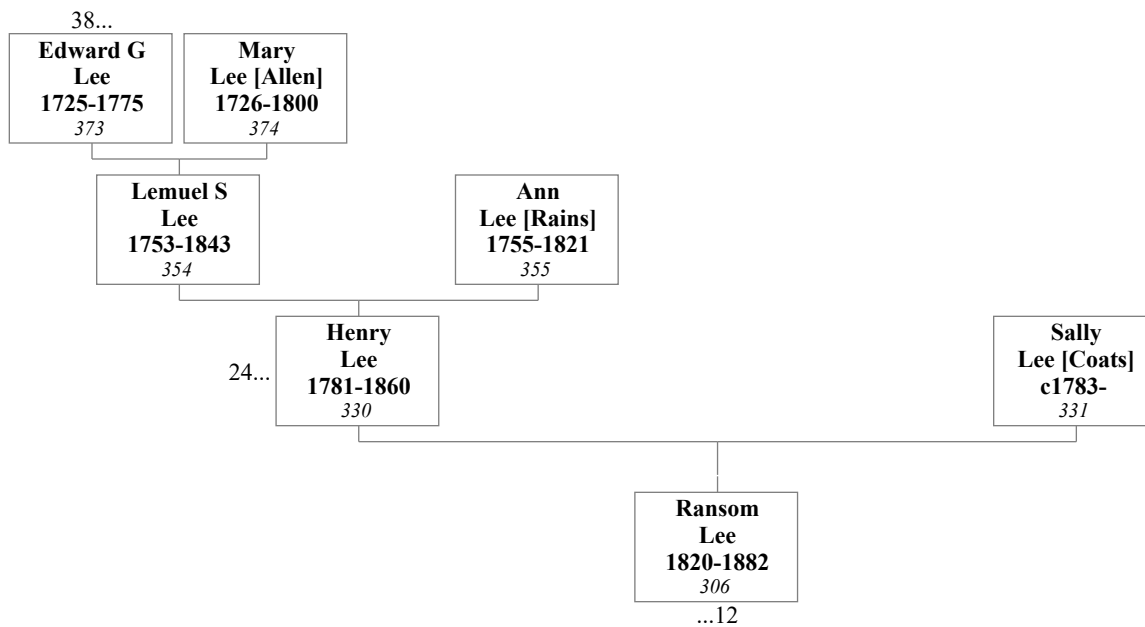

19. Hardy Britt and Charlotte Britt [Penny]

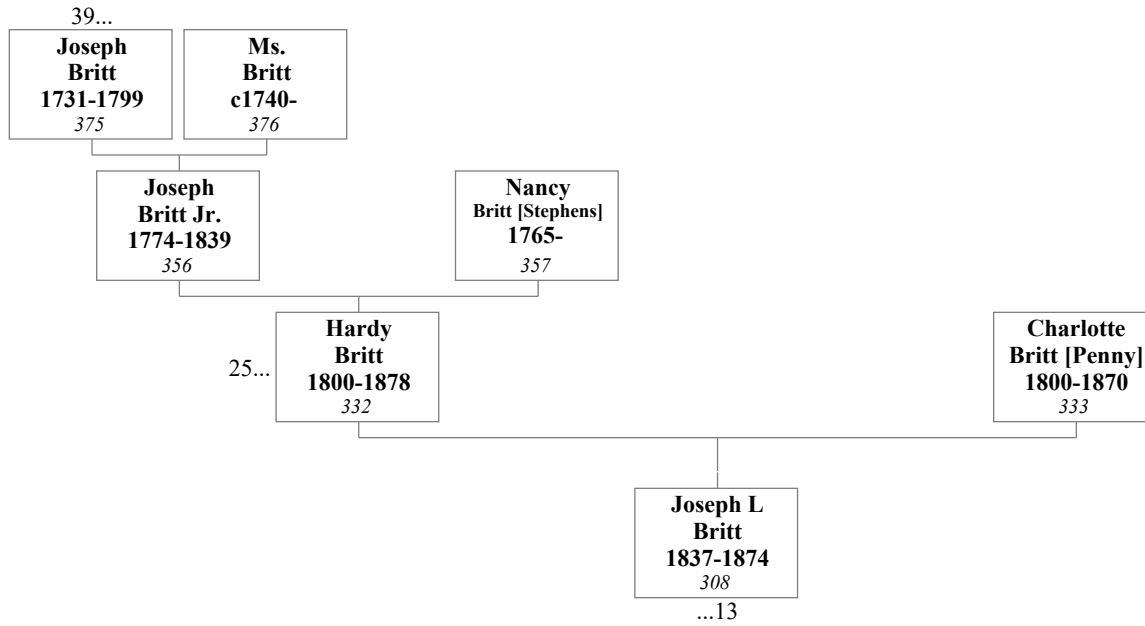

20. Thomas Jefferson Dupree and Allie Oliver Dupree [Gregory]

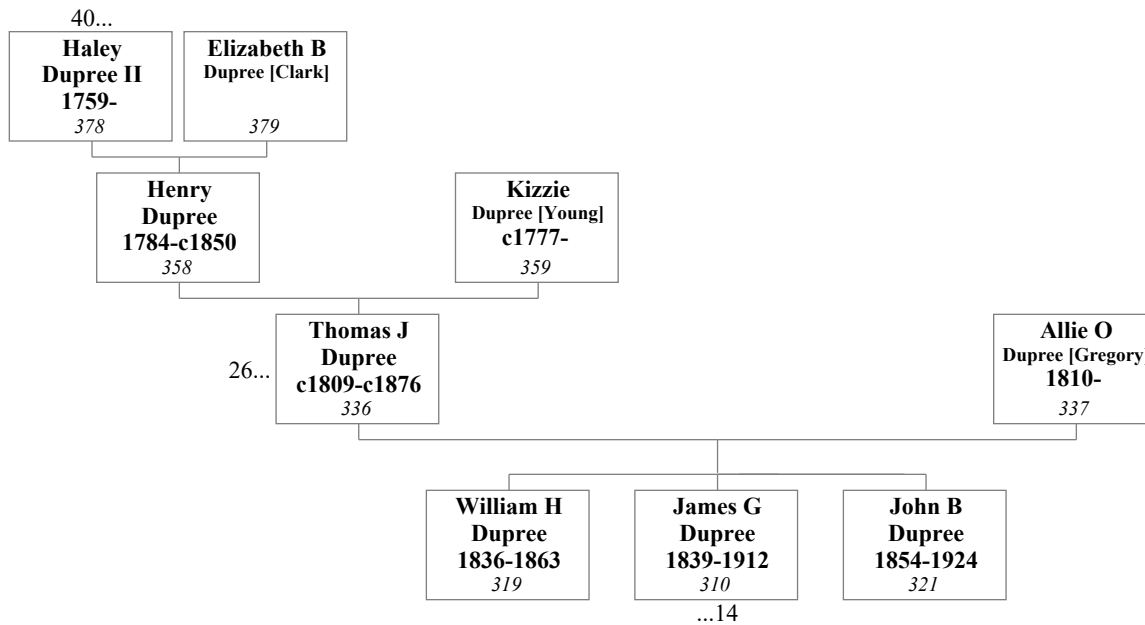

21. James "Jim" David Franks and Emma Gasten Franks [Jones]

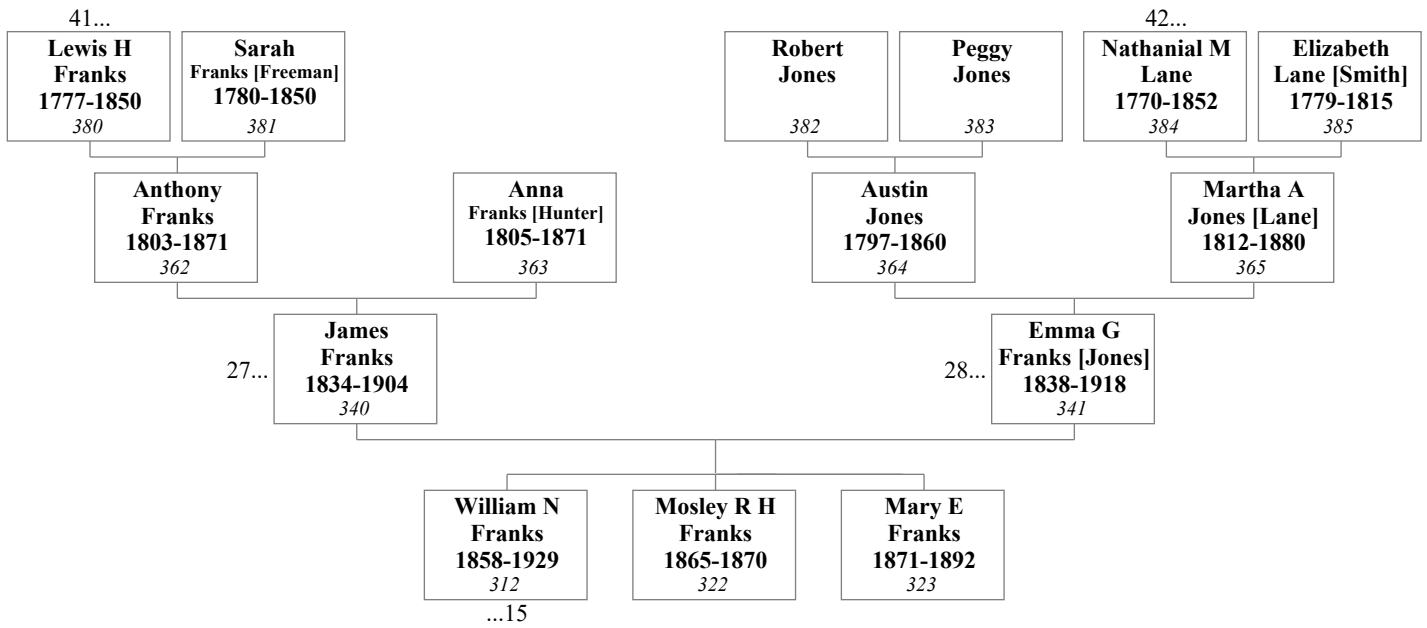

22. William Marshburn and Susan Marshburn [Ellis]

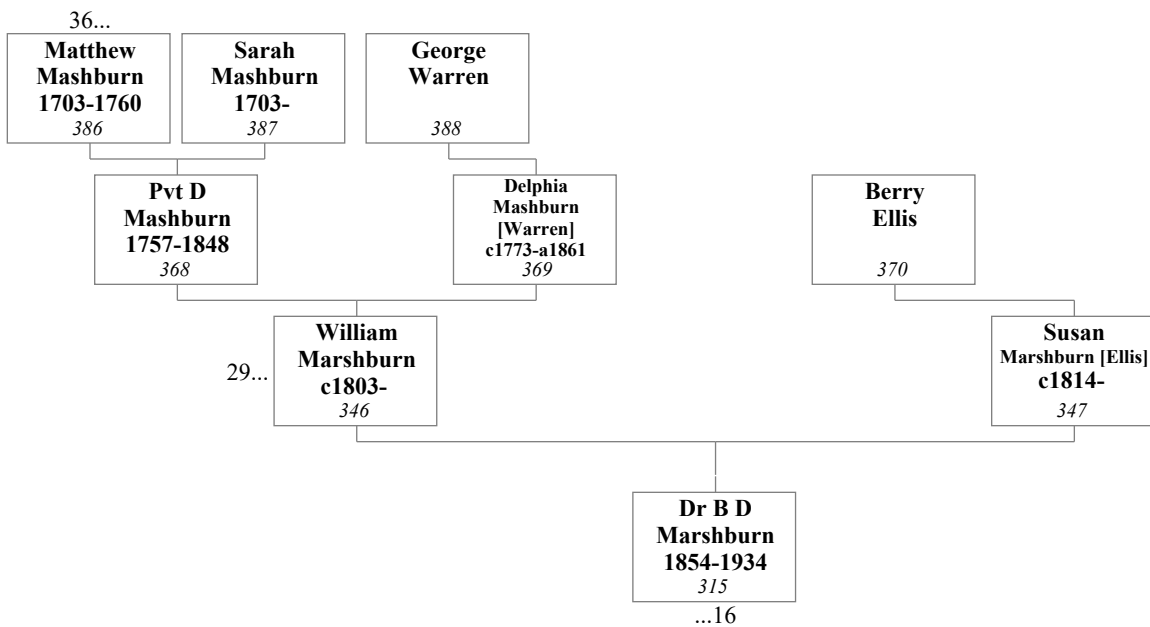

25. Joseph Britt Jr. and Nancy Britt [Stephens]

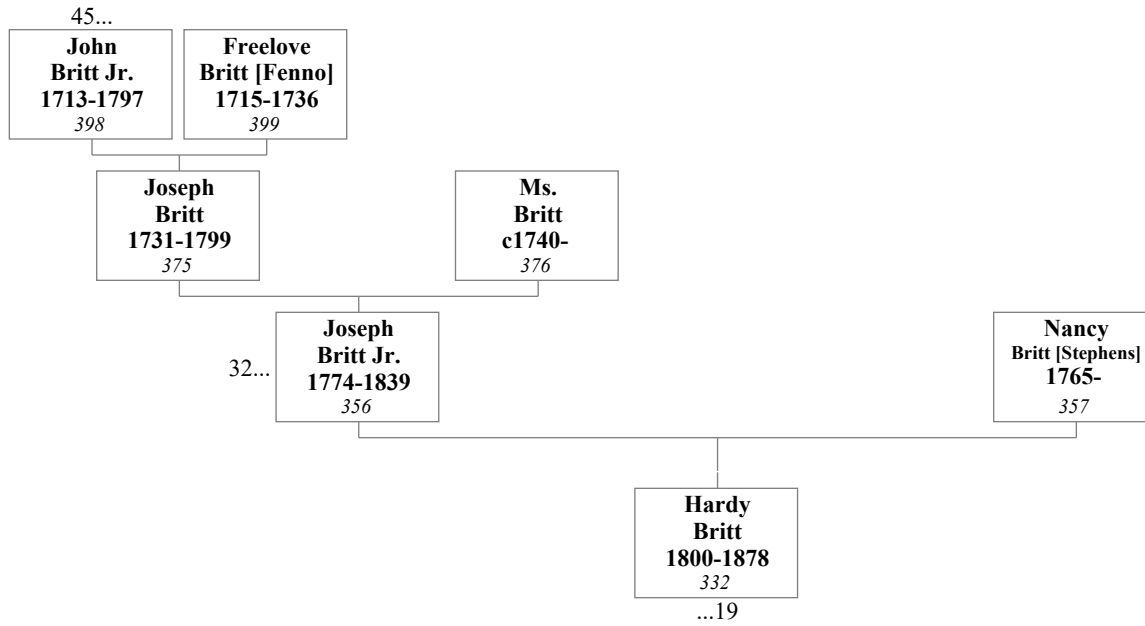

26. Henry Dupree and Kizzie Dupree [Young]

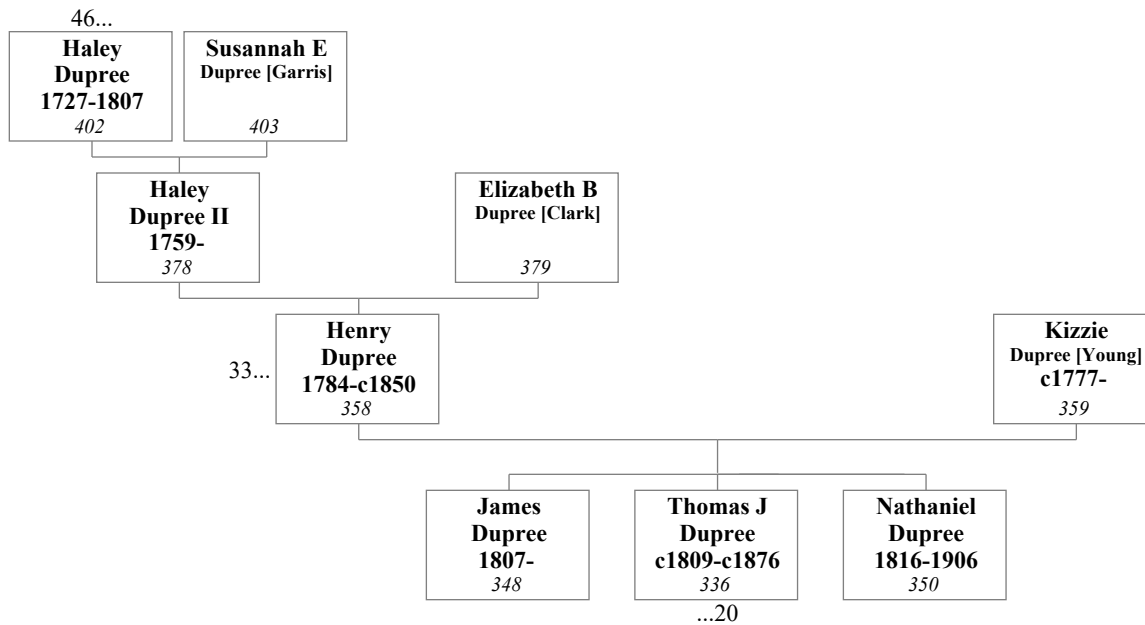

27. Anthony Franks and Anna Franks [Hunter]

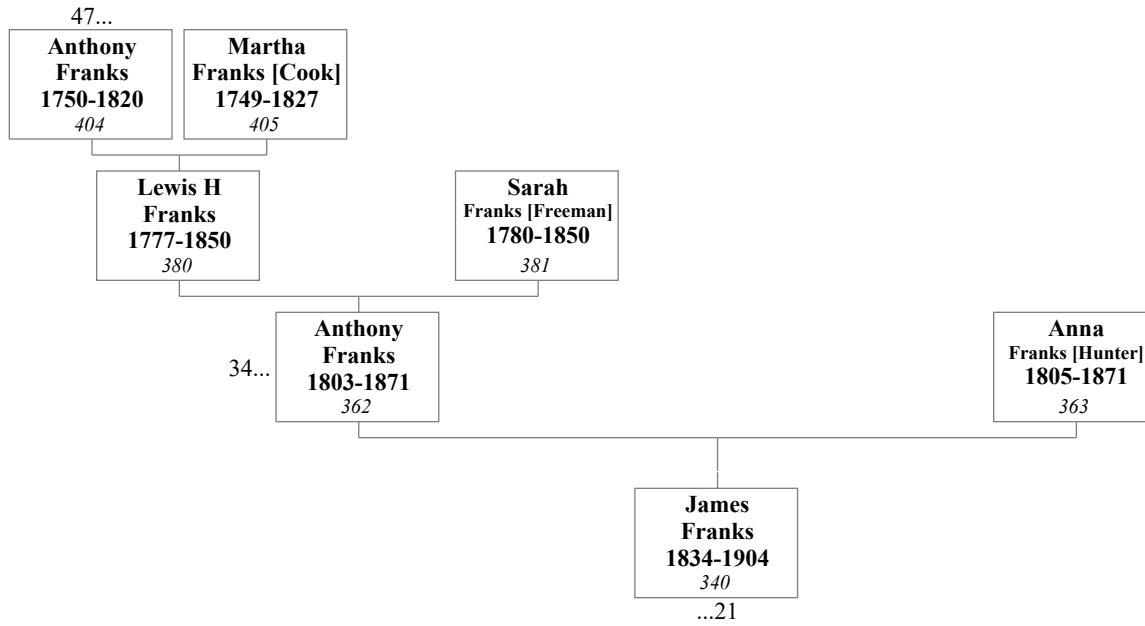

28. Austin Jones and Martha Ann Jones [Lane]

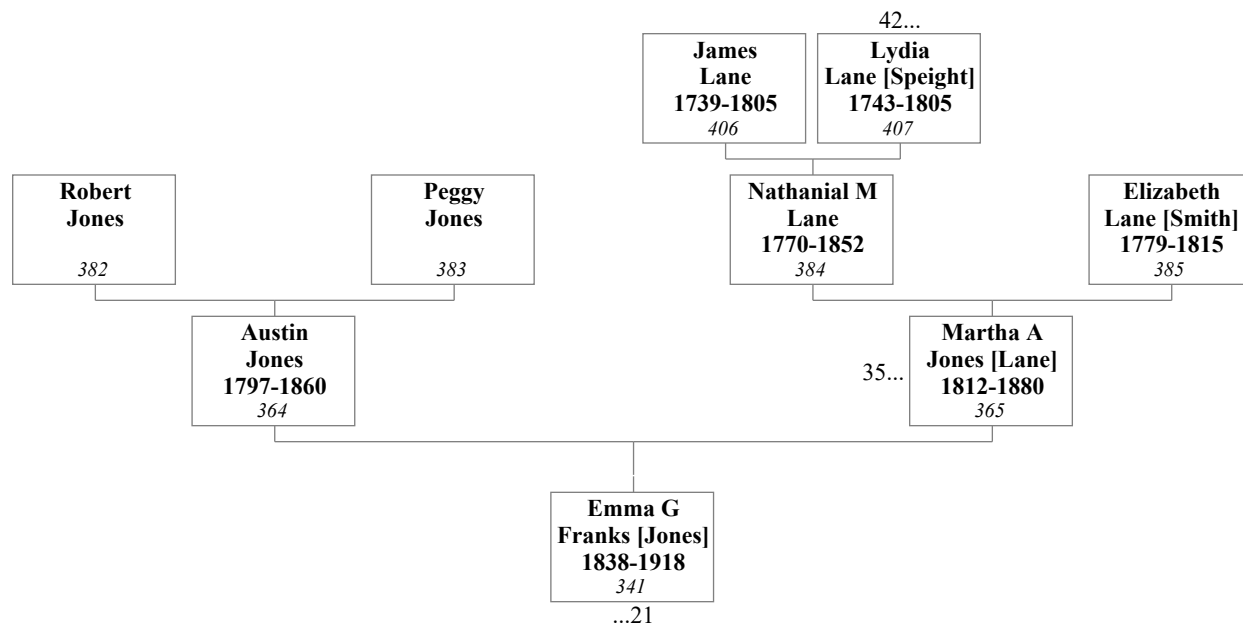

29. Pvt Daniel Mashburn and Delphia Mashburn [Warren]

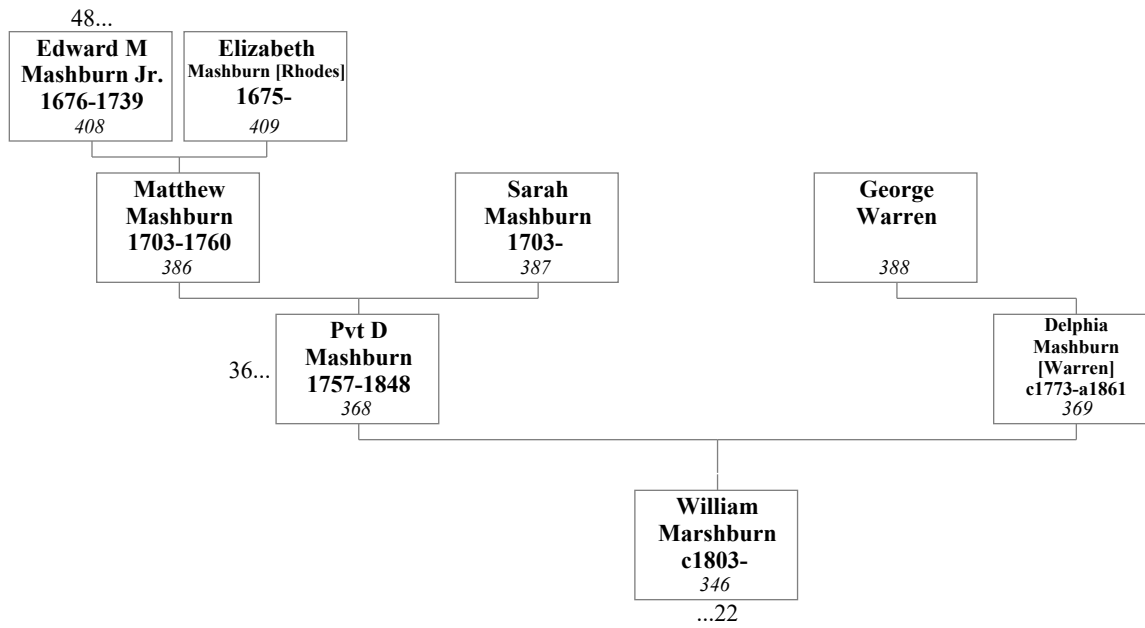

30. Jacob Woodall and Agnes Woodall [Hicks]

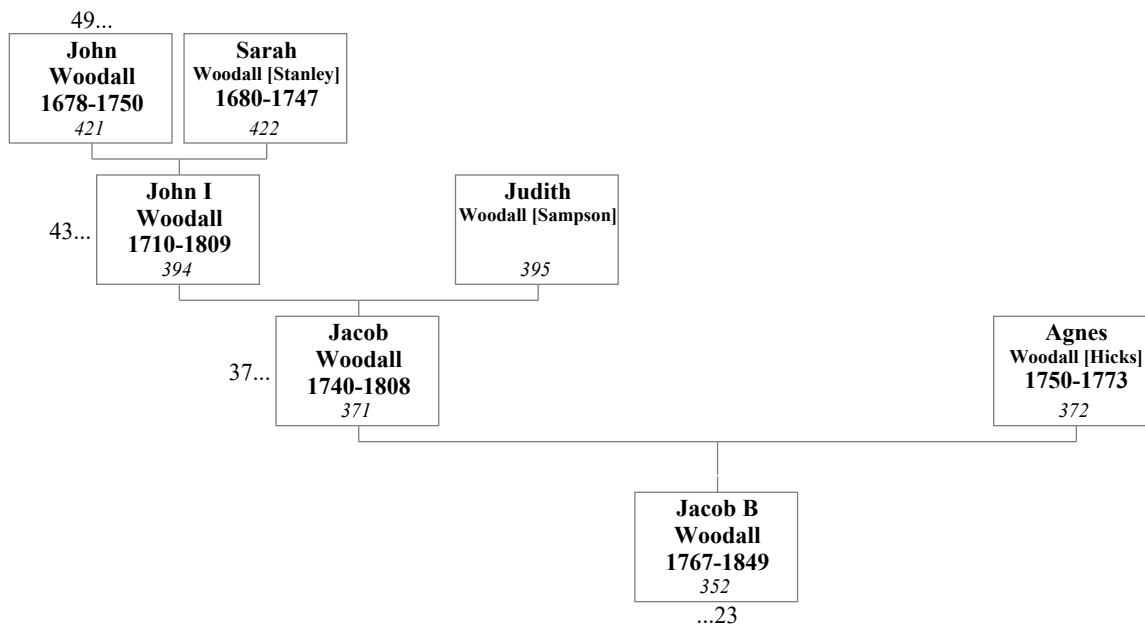

31. Edward G Lee and Mary Lee [Allen]

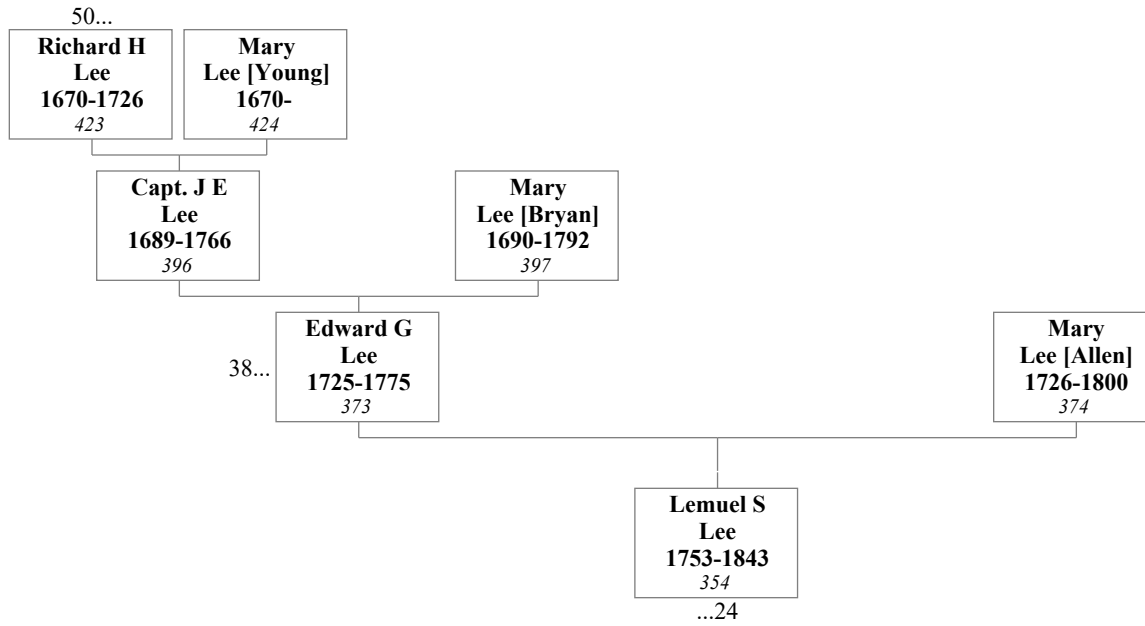

32. Joseph Britt and Ms. Britt

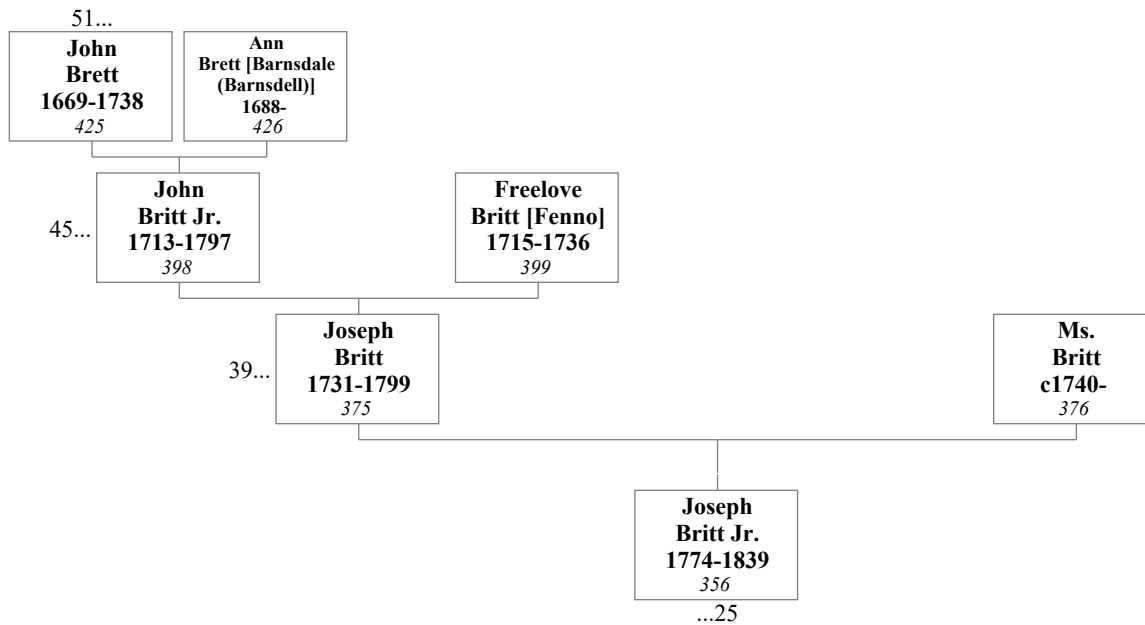

33. Haley Dupree II and Elizabeth Bettie Dupree [Clark]

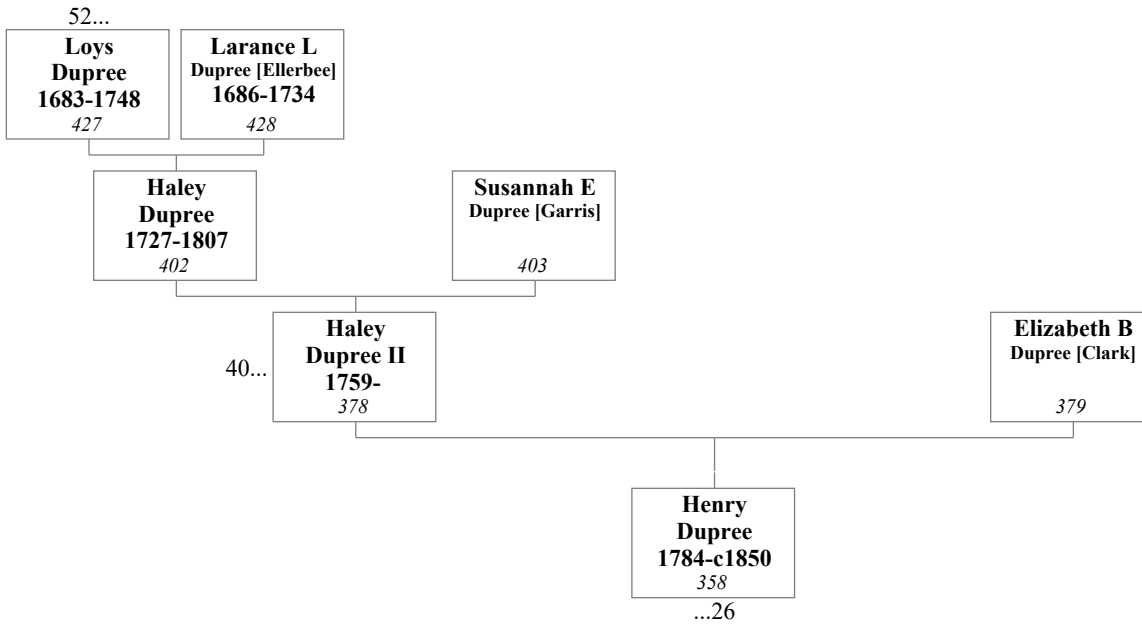

34. Lewis Henry Franks and Sarah Franks [Freeman]

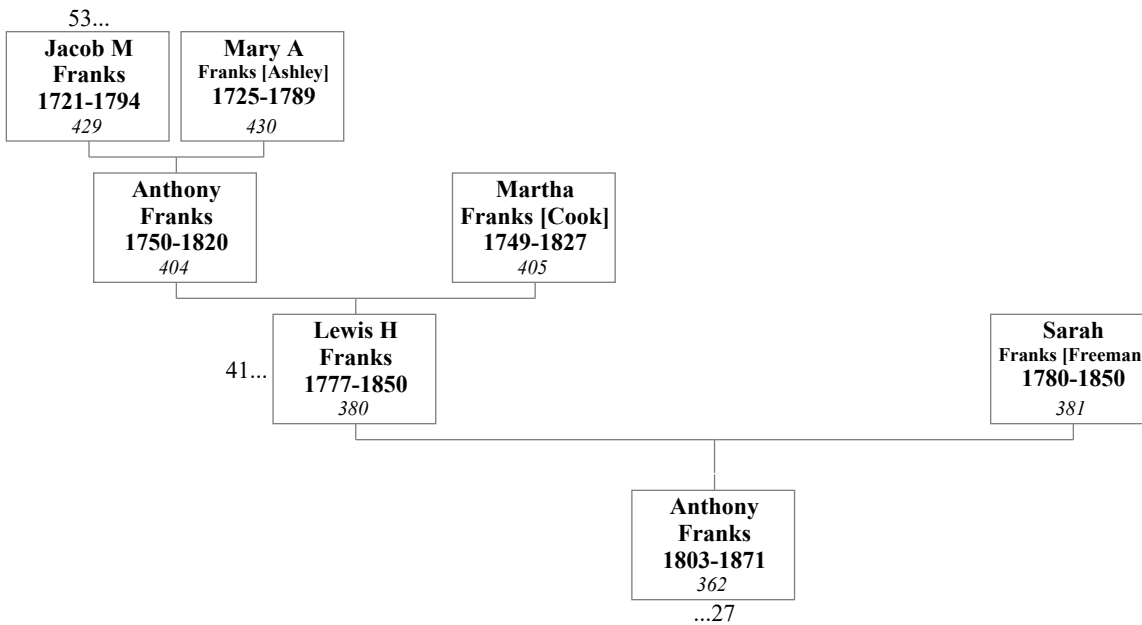

35. Nathaniel M. Lane and Elizabeth Lane [Smith]

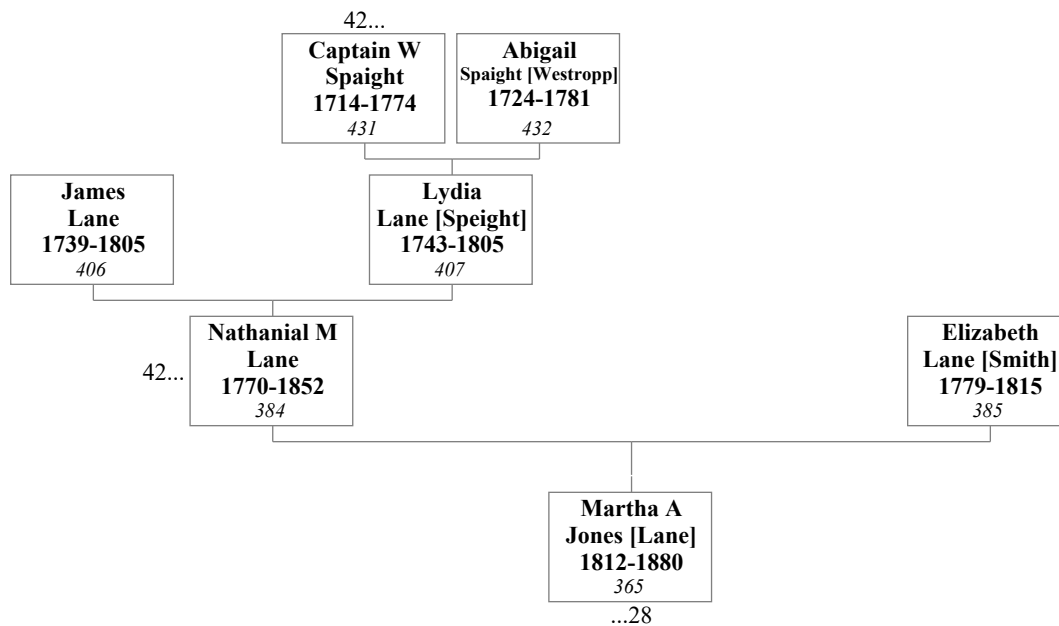

36. Matthew Mashburn and Sarah Mashburn

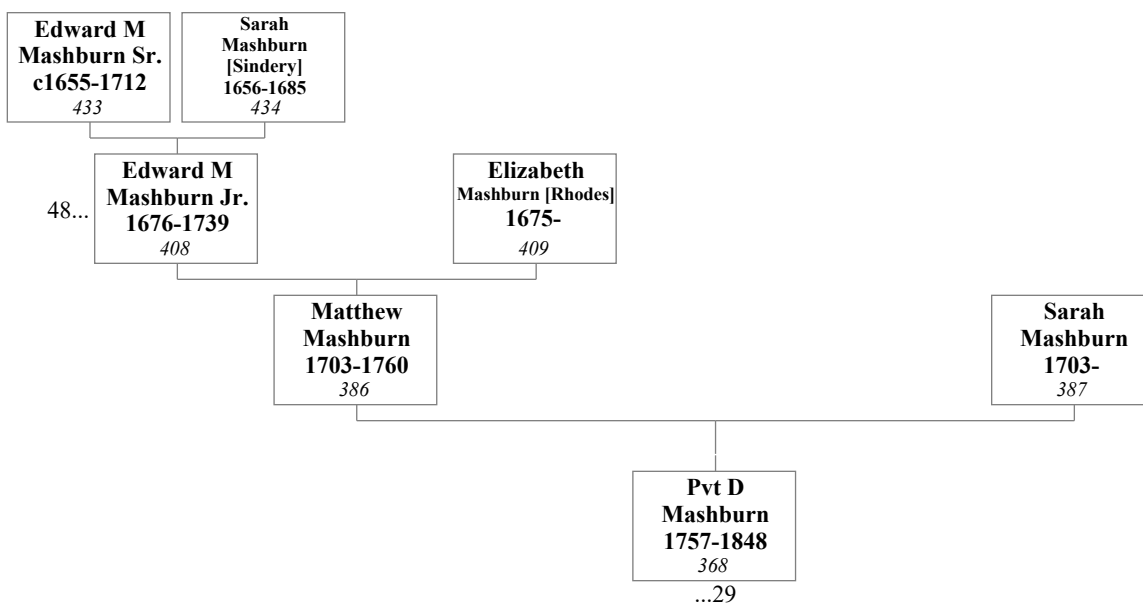

37. John Issac Woodall and Judith Woodall [Sampson]

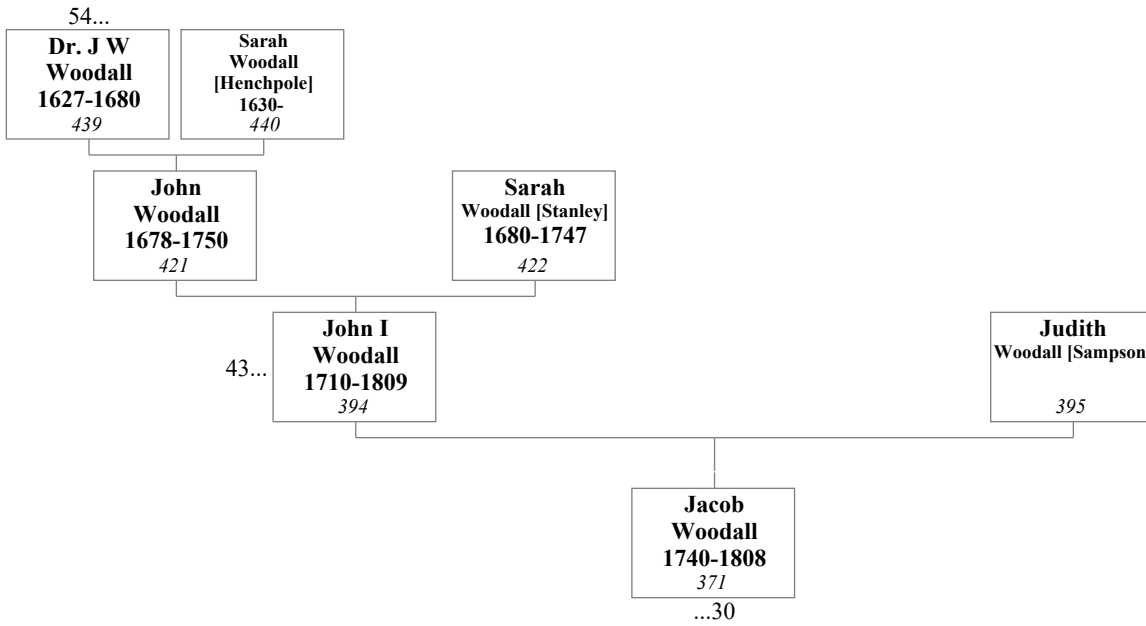

38. Capt. John Esquire Lee and Mary Lee [Bryan]

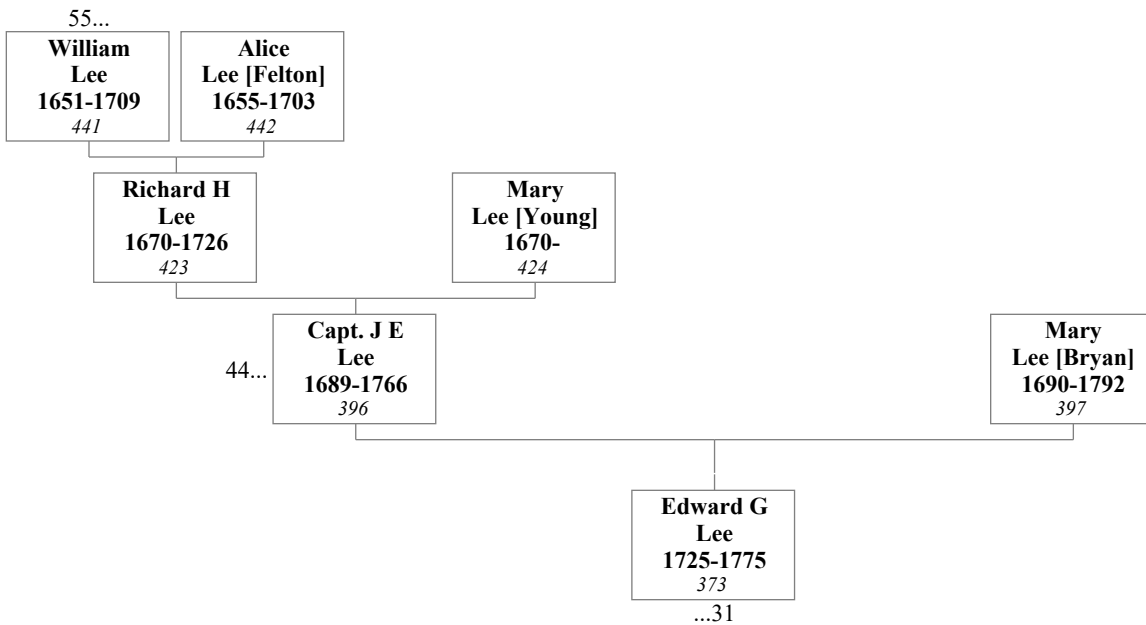

39. John Britt Jr. and Freelope Britt [Fenno]

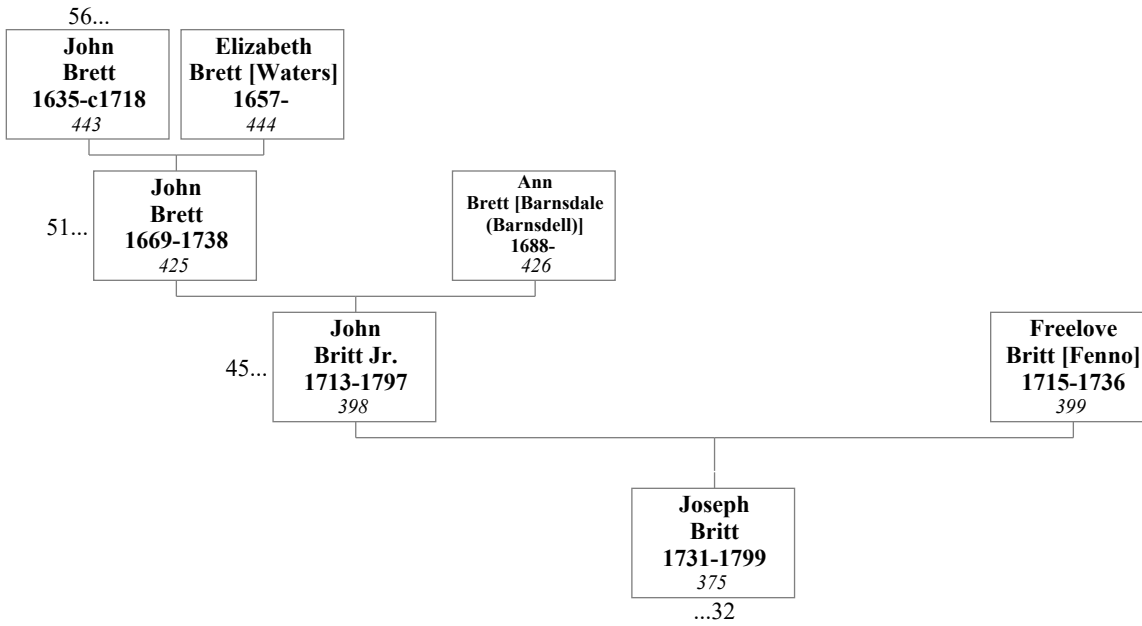

40. Haley Dupree and Susannah Elizabeth Dupree [Garris]

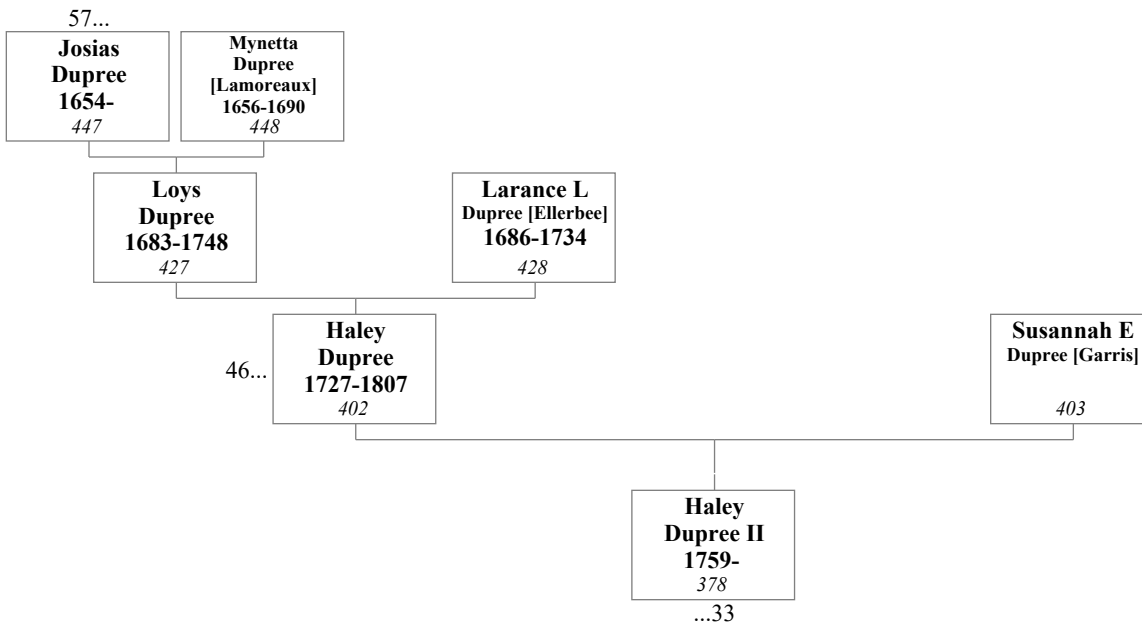

43. John Woodall and Sarah Woodall [Stanley]

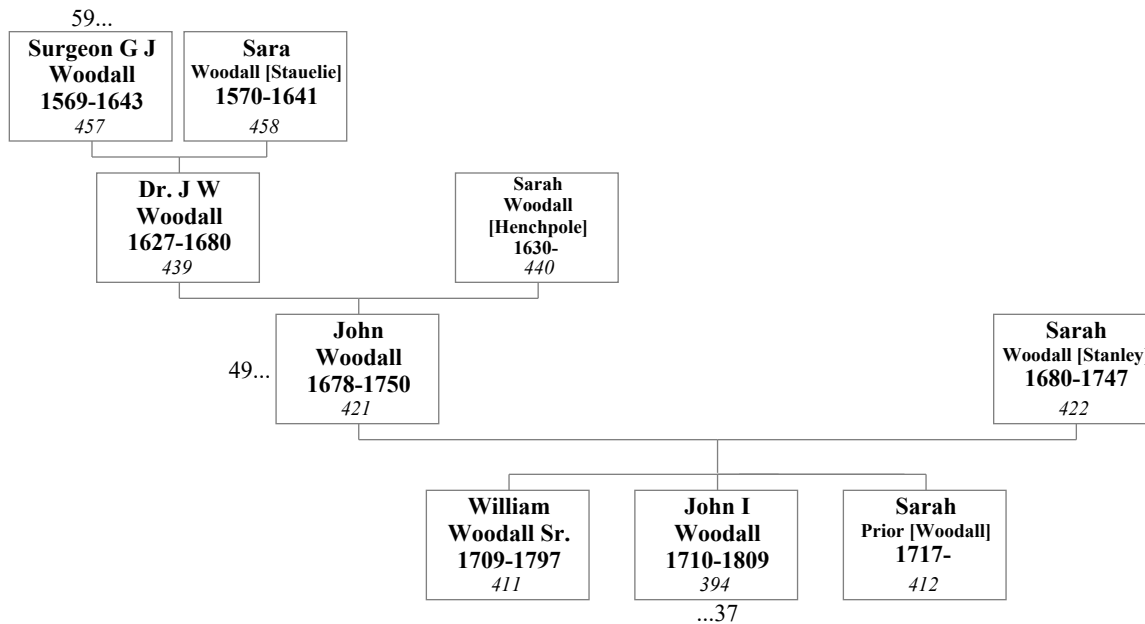

44. Richard Henry Lee and Mary Lee [Young]

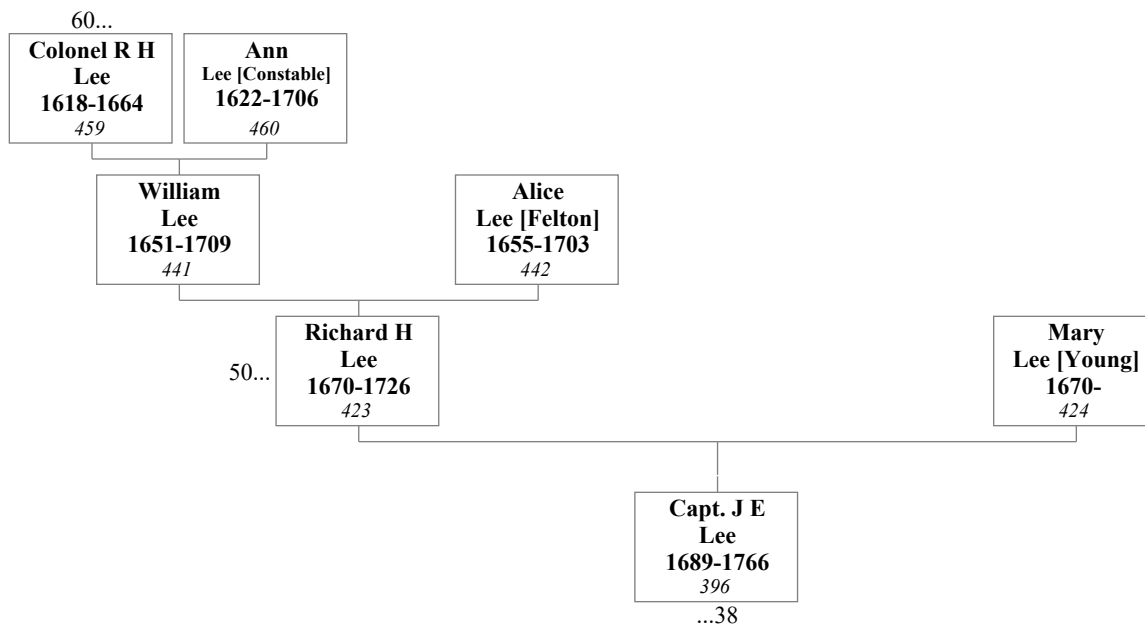

45. John Brett and Ann Brett [Barnsdale (Barnsdell)]

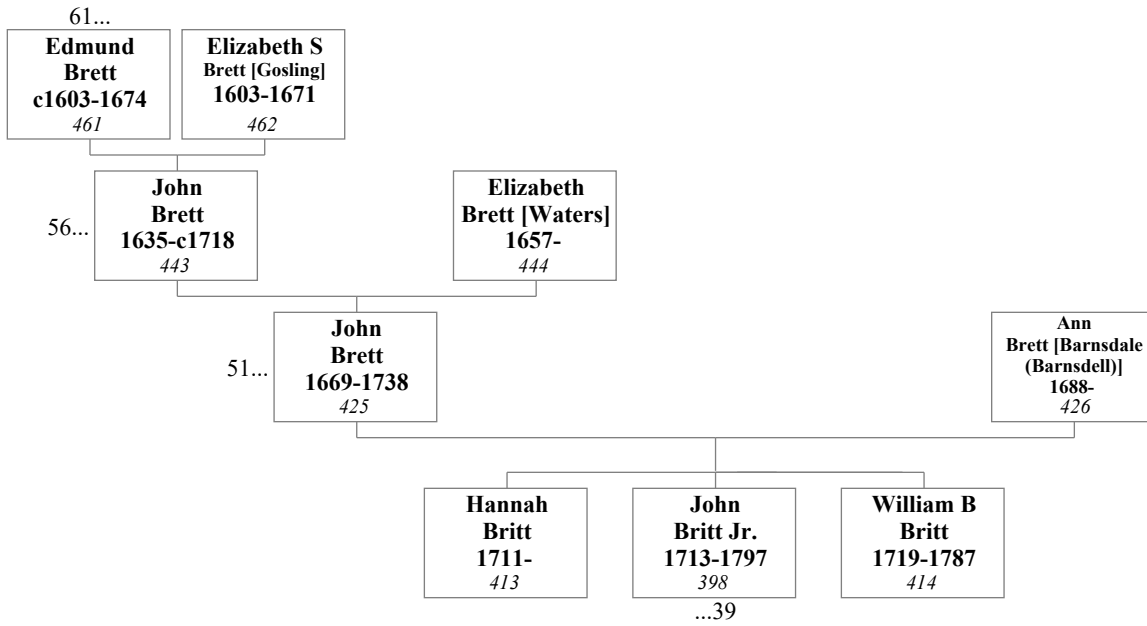

46. Loys "Louis" Dupree and Larence Lara Dupree [Ellerbe]

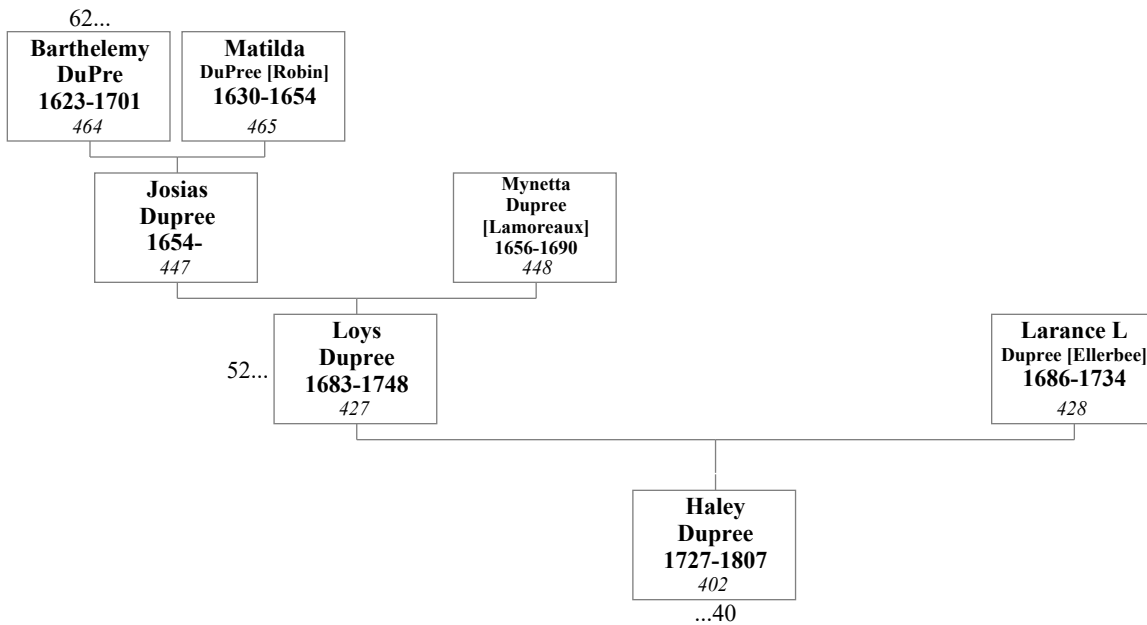

47. Jacob Miller Franks and Mary Ann Franks [Ashley]

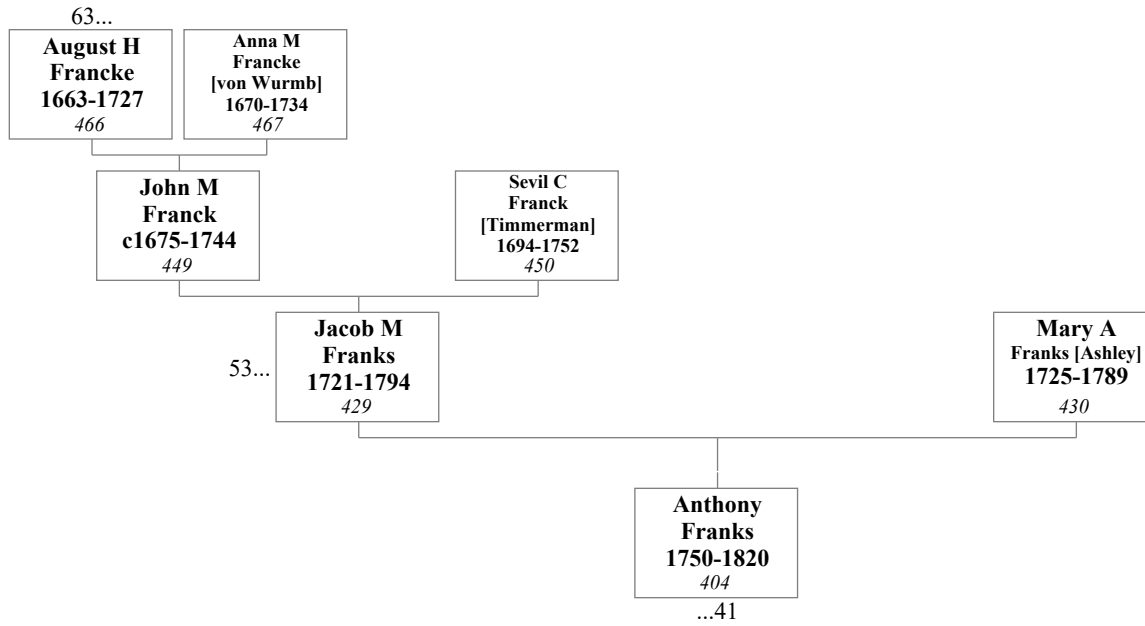

48. Edward Mashborne Mashburn Sr. and Sarah Mashburn [Sindery]

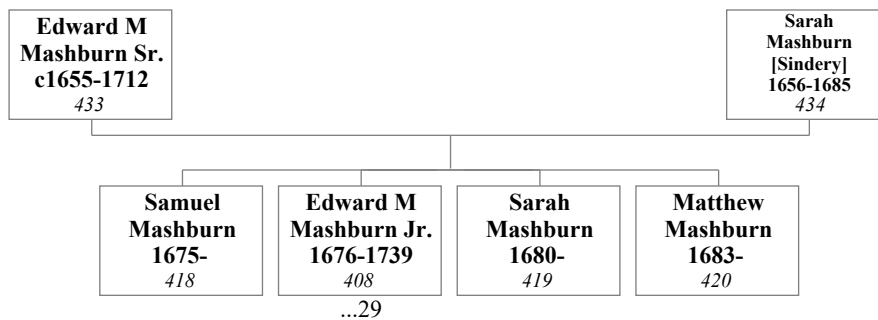

49. Dr. John William Woodall and Sarah Woodall [Henchpole]

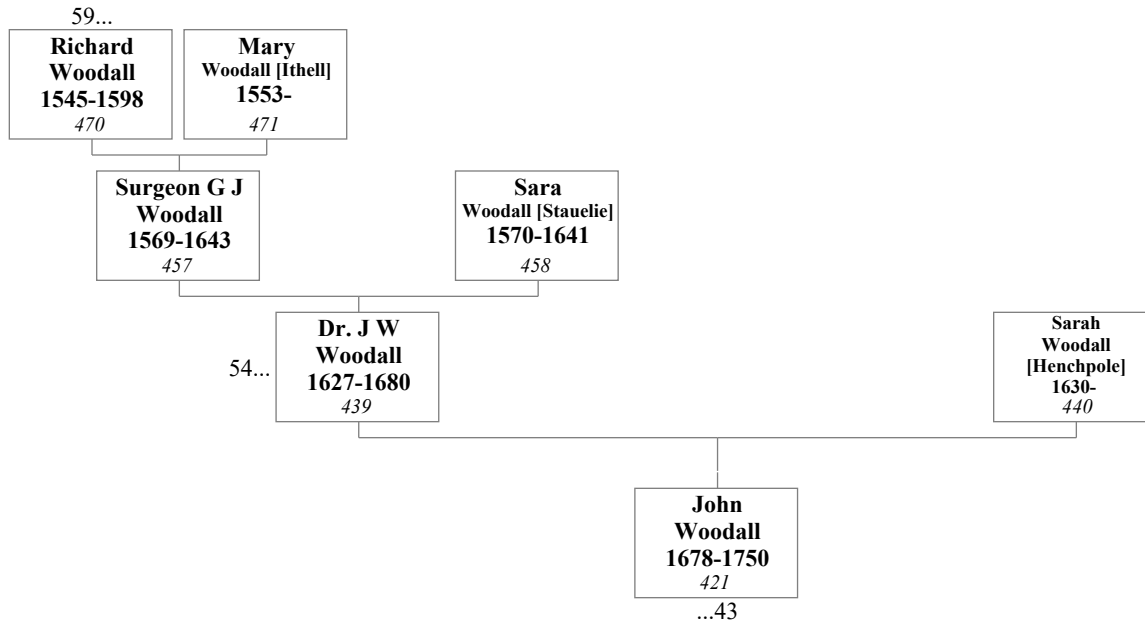

50. William Lee and Alice Lee [Felton]

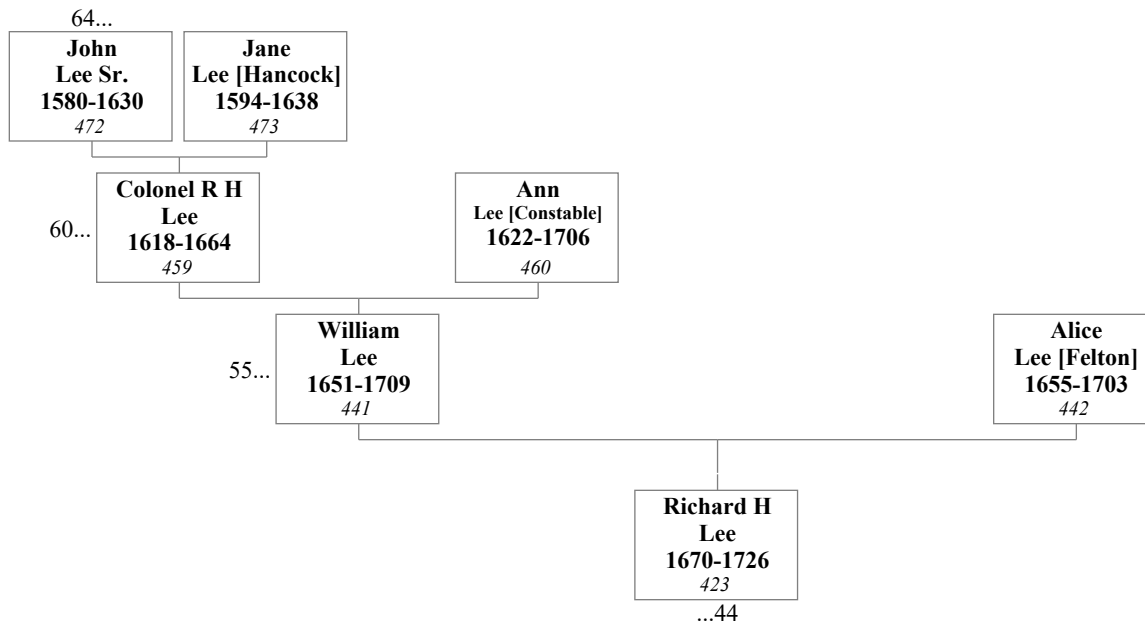

51. John Brett and Elizabeth Brett [Waters]

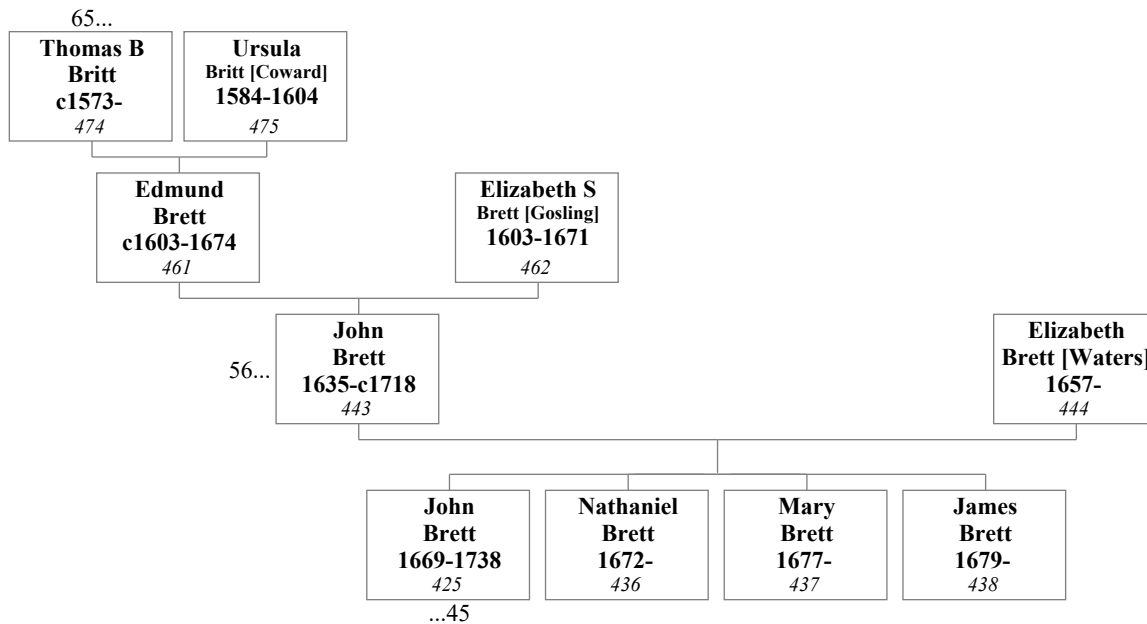

52. Josias "Joseph" Crancie Dupree and Mynetta "Mary" Denizot Dupree [Lamoreaux]

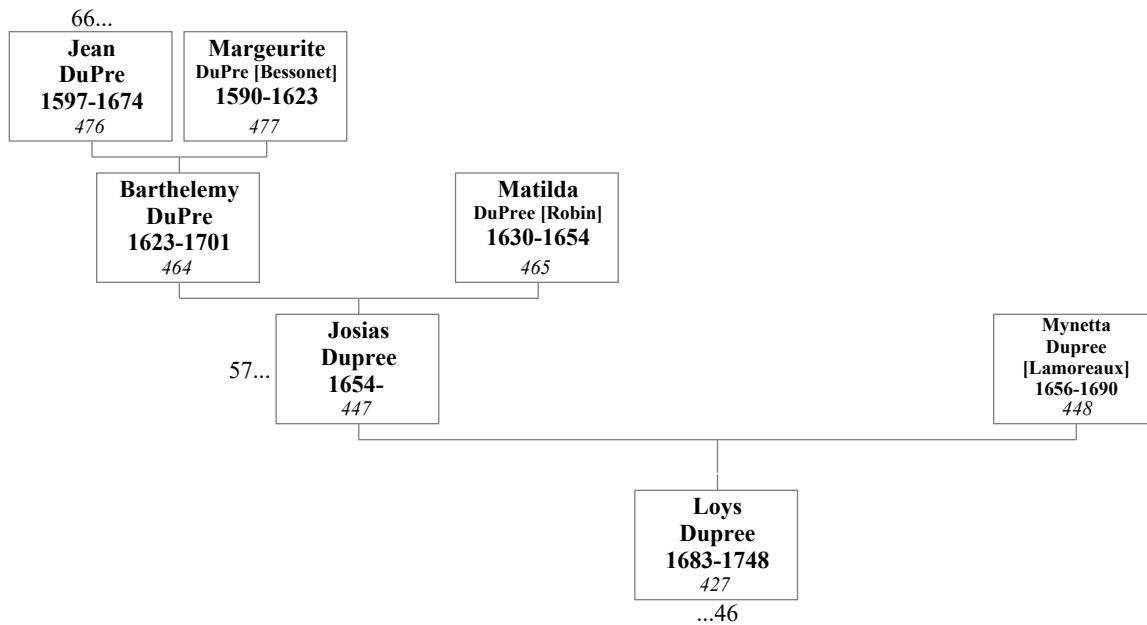

53. John Martin Franck and Sevil Civil Franck [Timmerman]

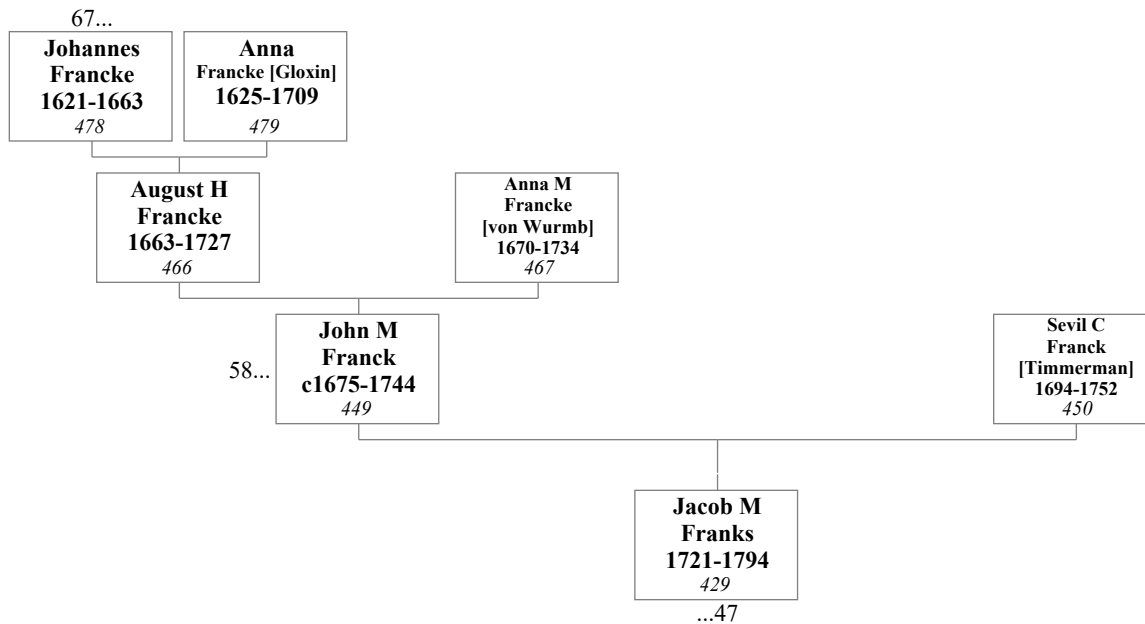

54. Surgeon General John Woodall and Sara Woodall [Staelie]

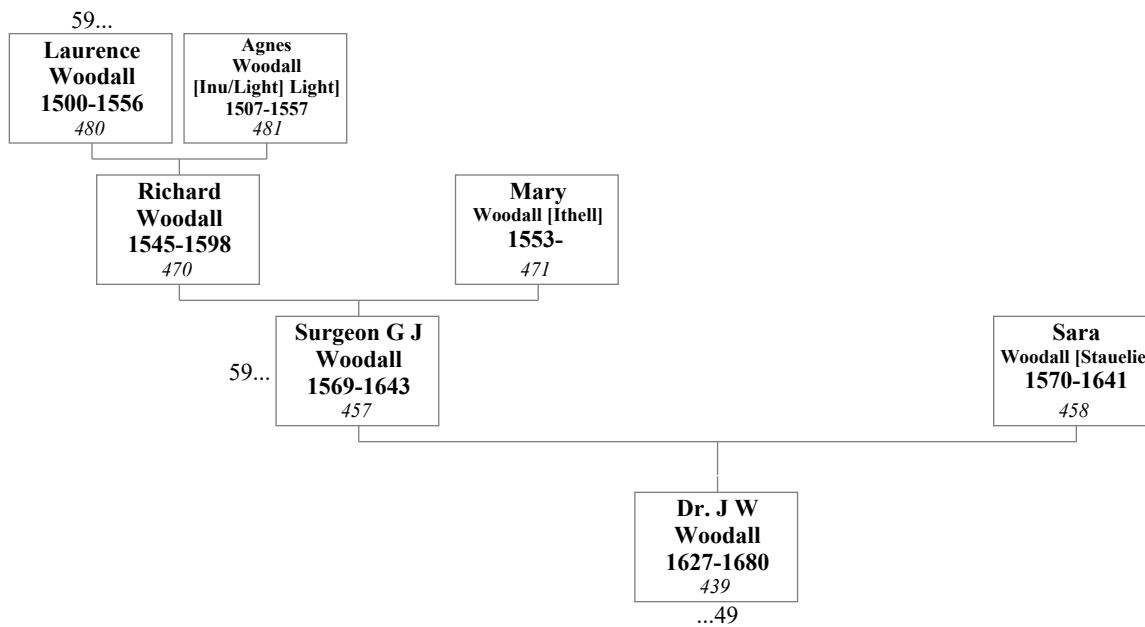

55. Colonel Richard Henry Lee and Ann Lee [Constable]

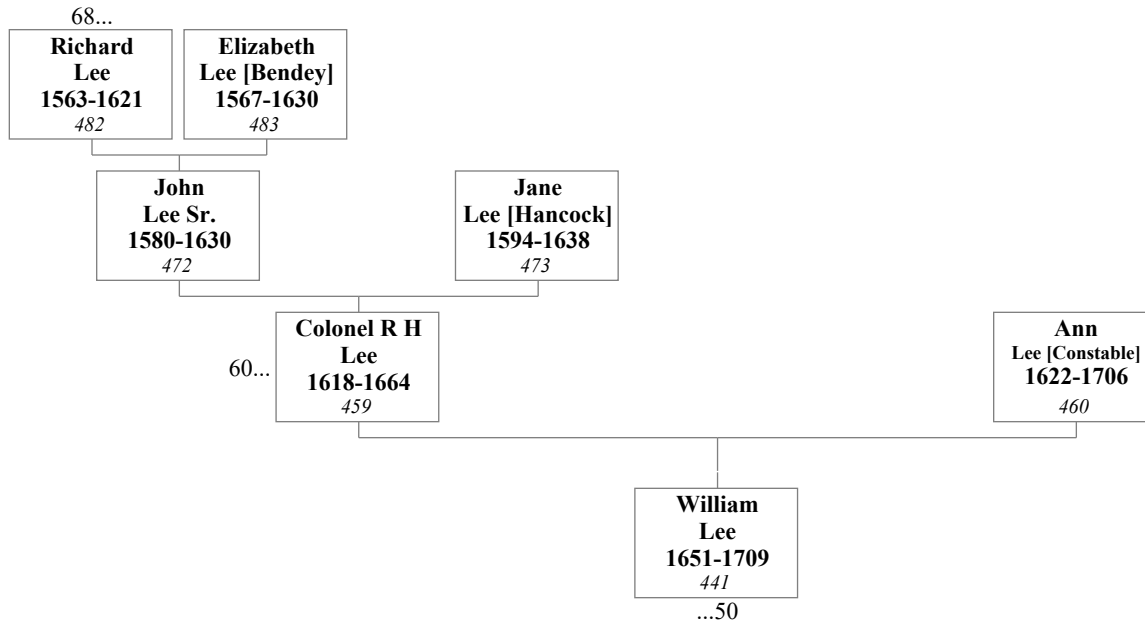

56. Edmund Brett and Elizabeth Susan Brett [Gosling]

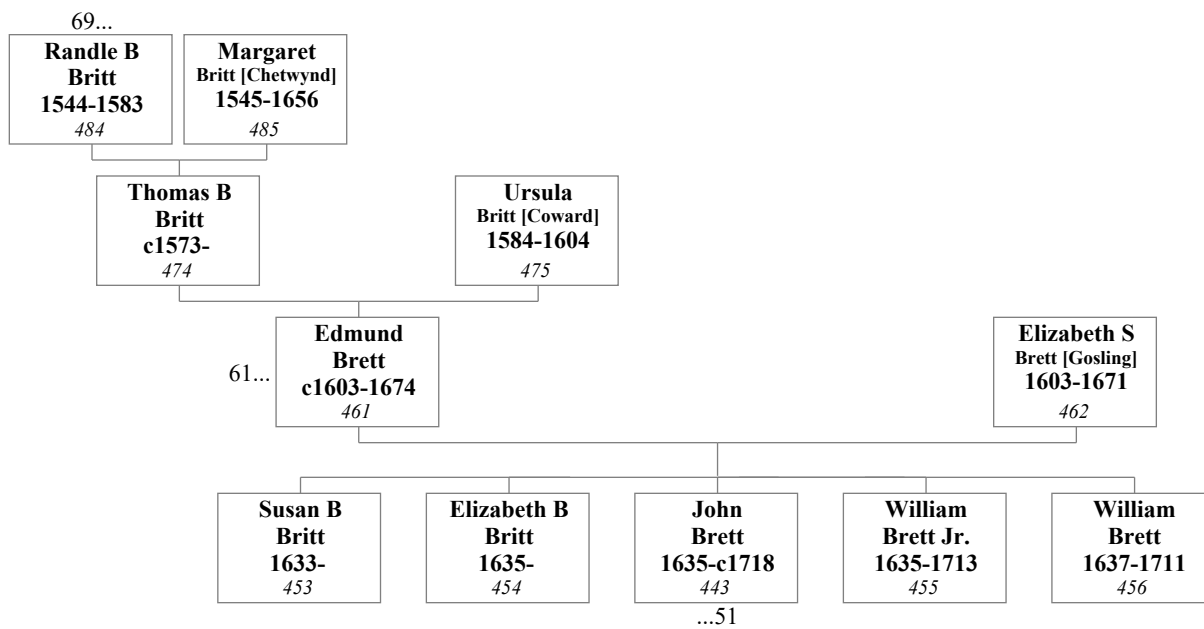

57. Barthelemy DuPre and Matilda DuPree [Robin]

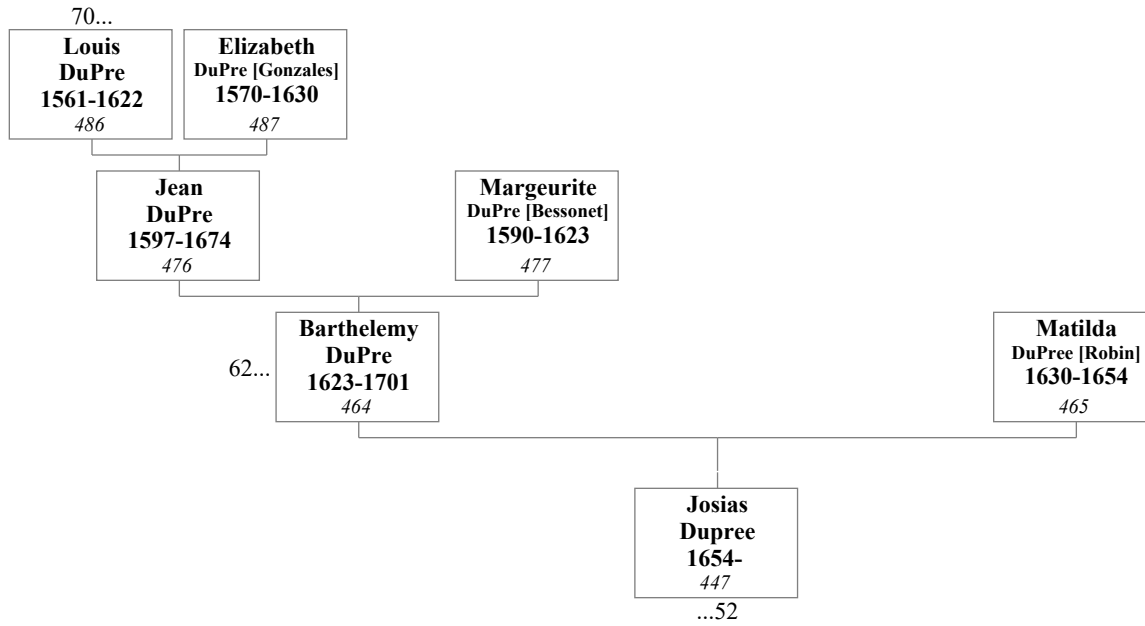

58. August Hermann Francke and Anna Magdalena Francke [von Wurmb]

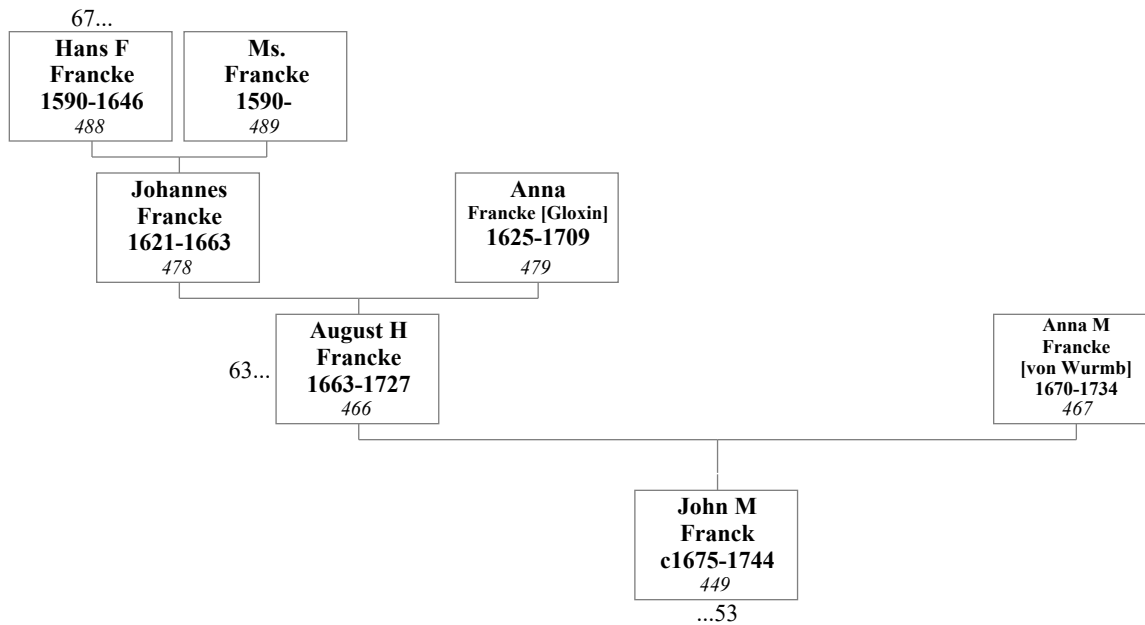

59. Richard Woodall and Mary Woodall [Ithell]

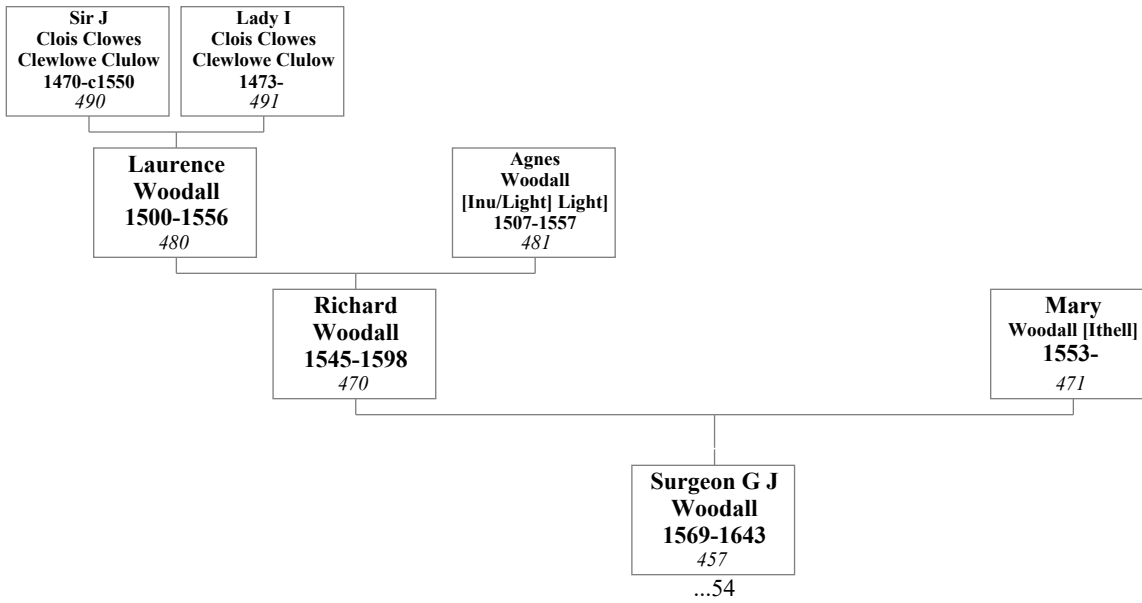

60. John Lee Sr. and Jane Lee [Hancock]

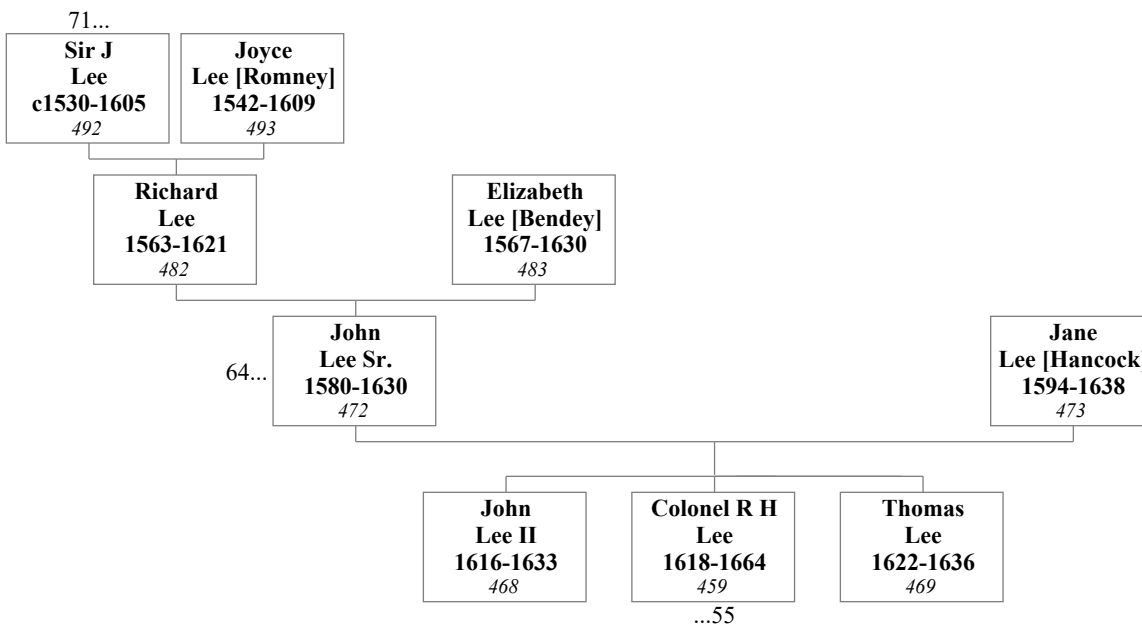

61. Thomas Brett Britt and Ursula Britt [Coward]

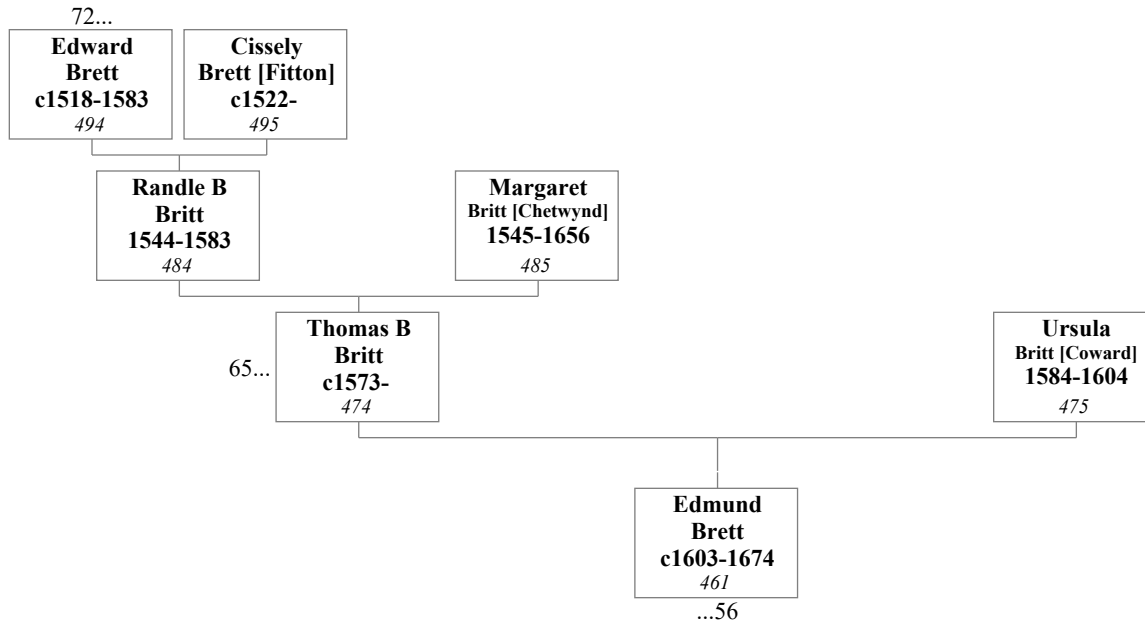

62. Jean DuPre and Margeurite DuPre [Bessonet]

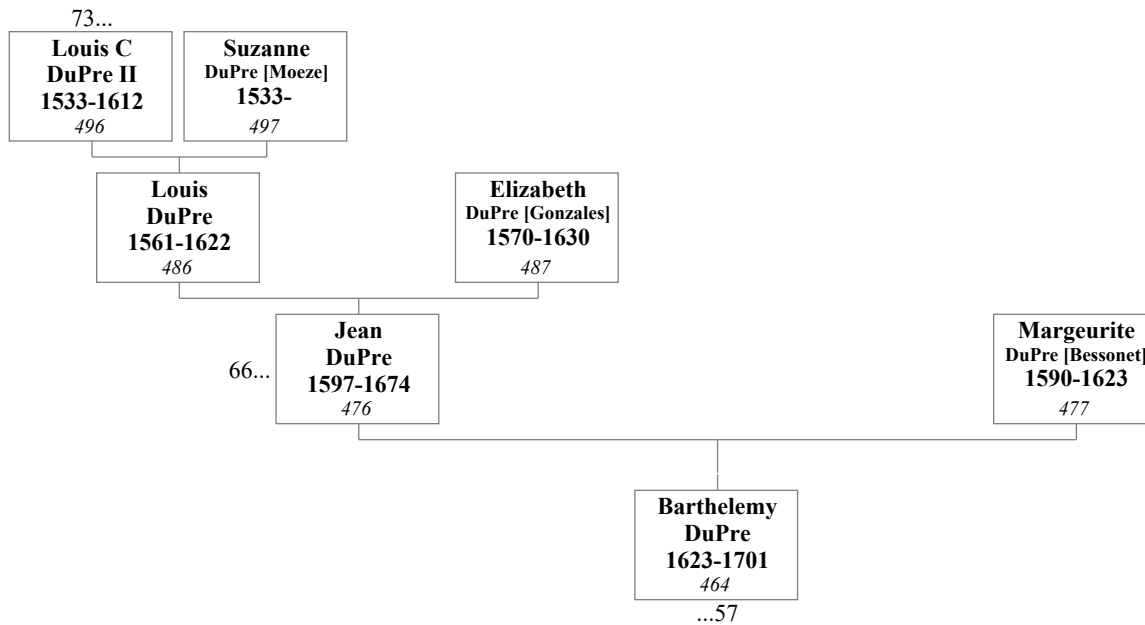

63. Johannes Francke and Anna Francke [Gloxin]

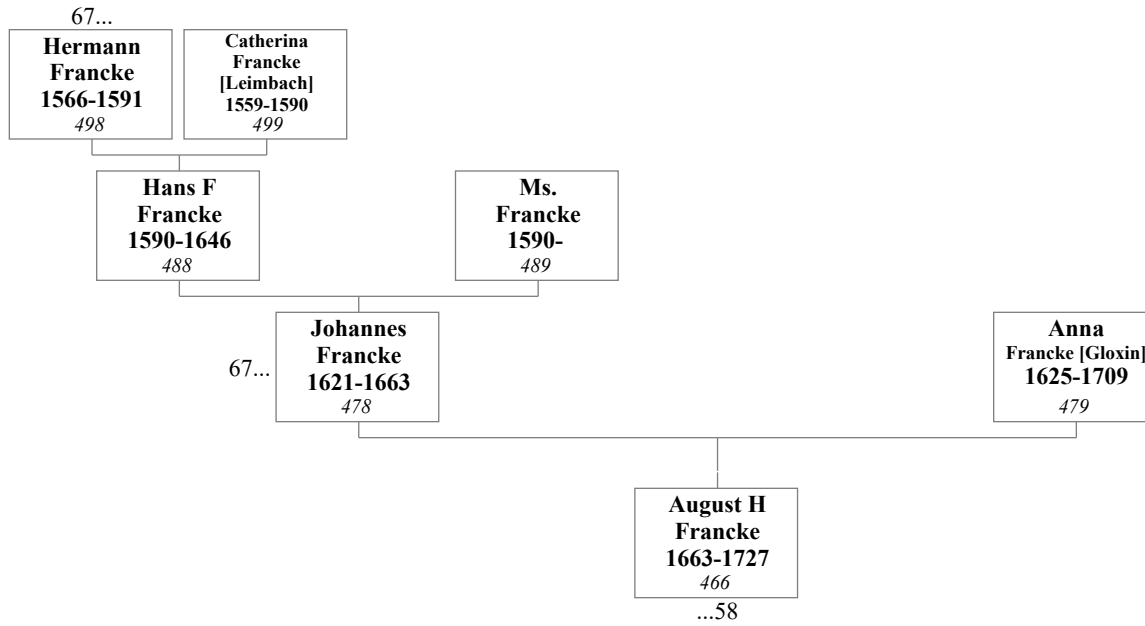

64. Richard Lee and Elizabeth Lee [Bendey]

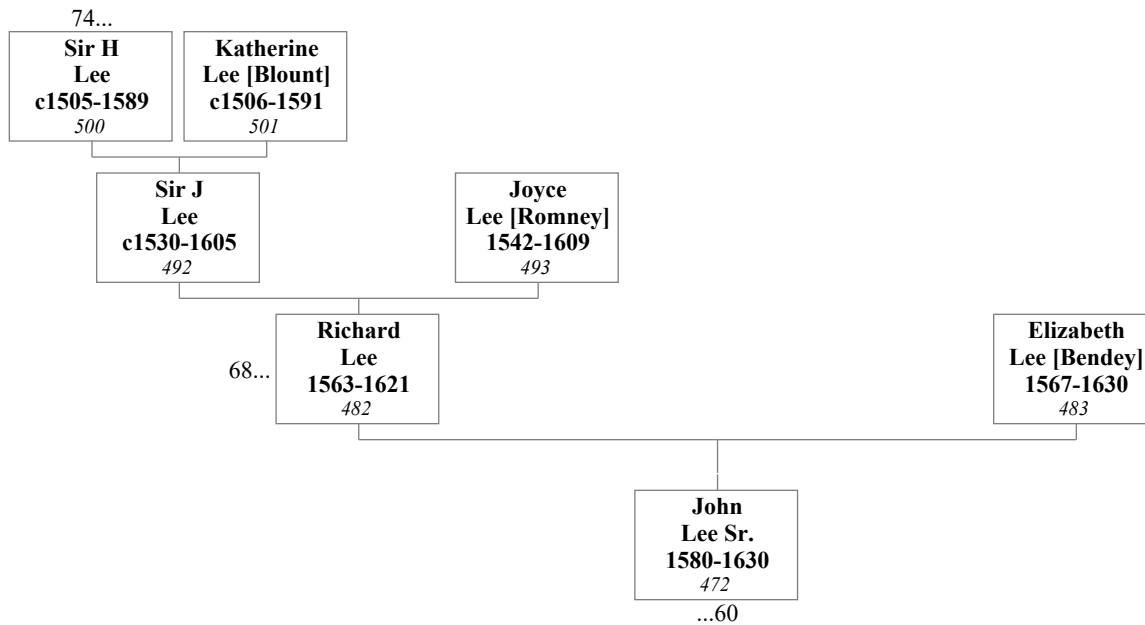

65. Randle Brett Britt and Margaret Britt [Chetwynd]

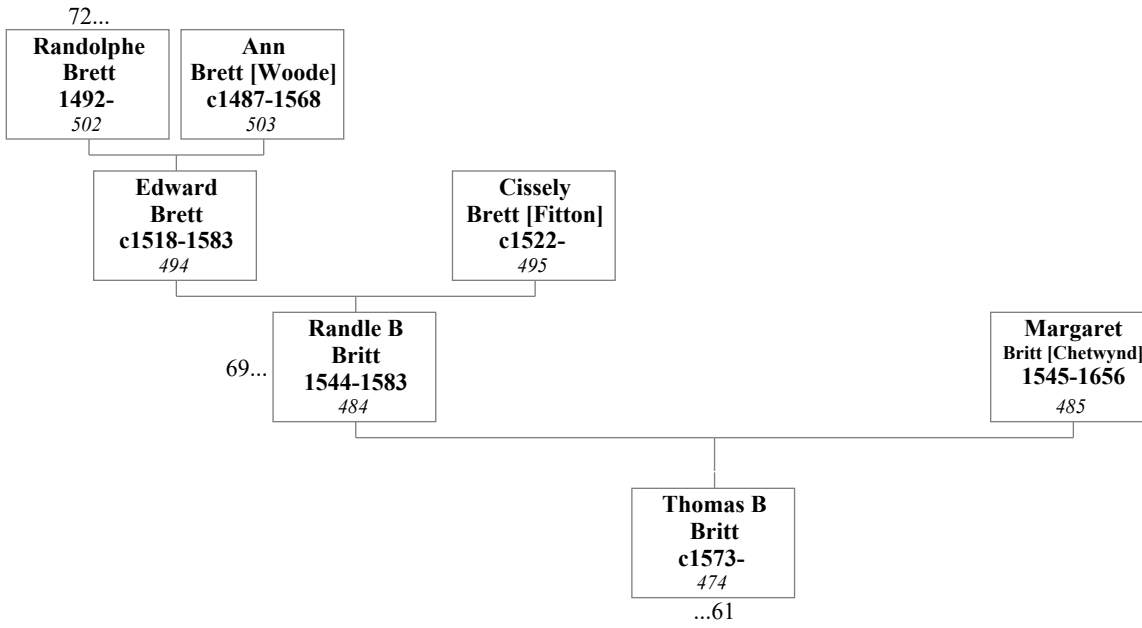

66. Louis DuPre and Elizabeth DuPre [Gonzales]

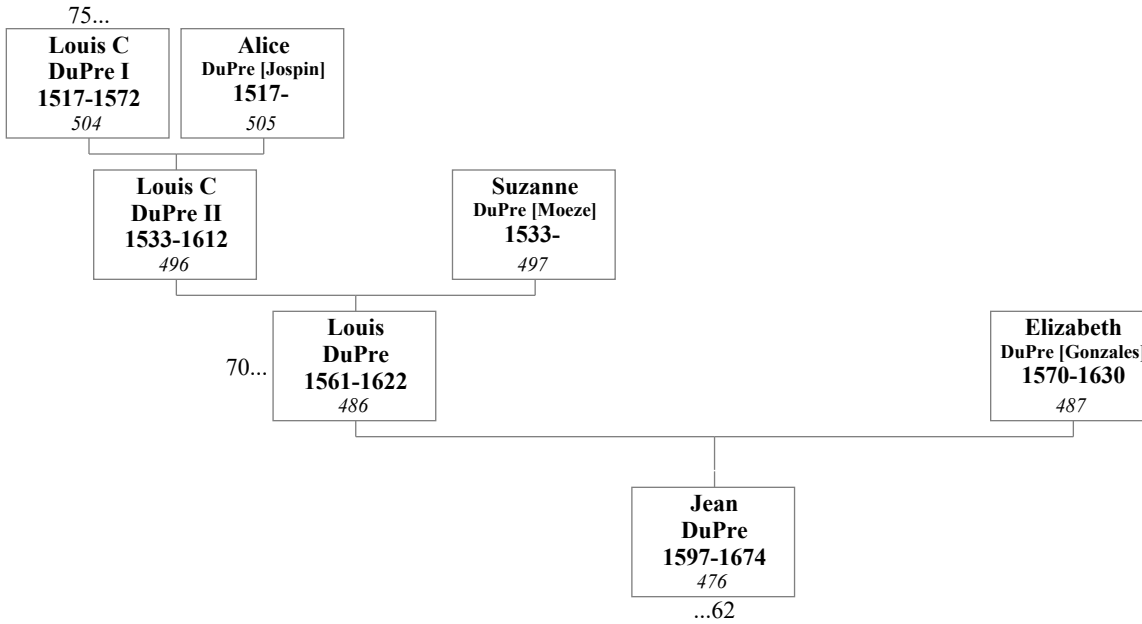

67. Hans Francke Francke and Ms. Francke

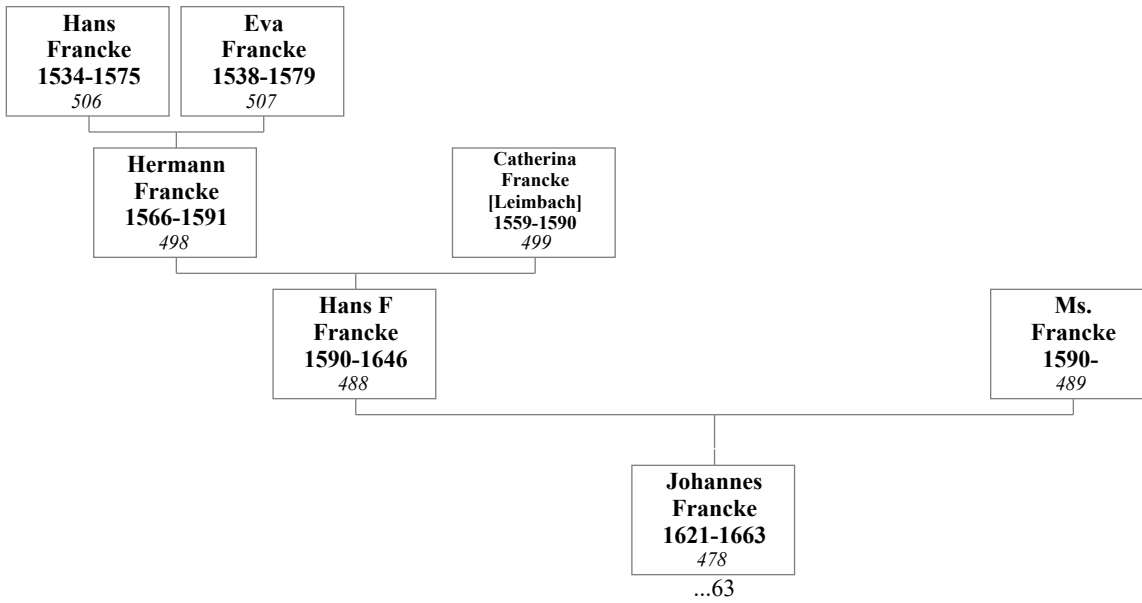

68. Sir John "John Lee Esquire" Lee and Joyce Lee [Romney]

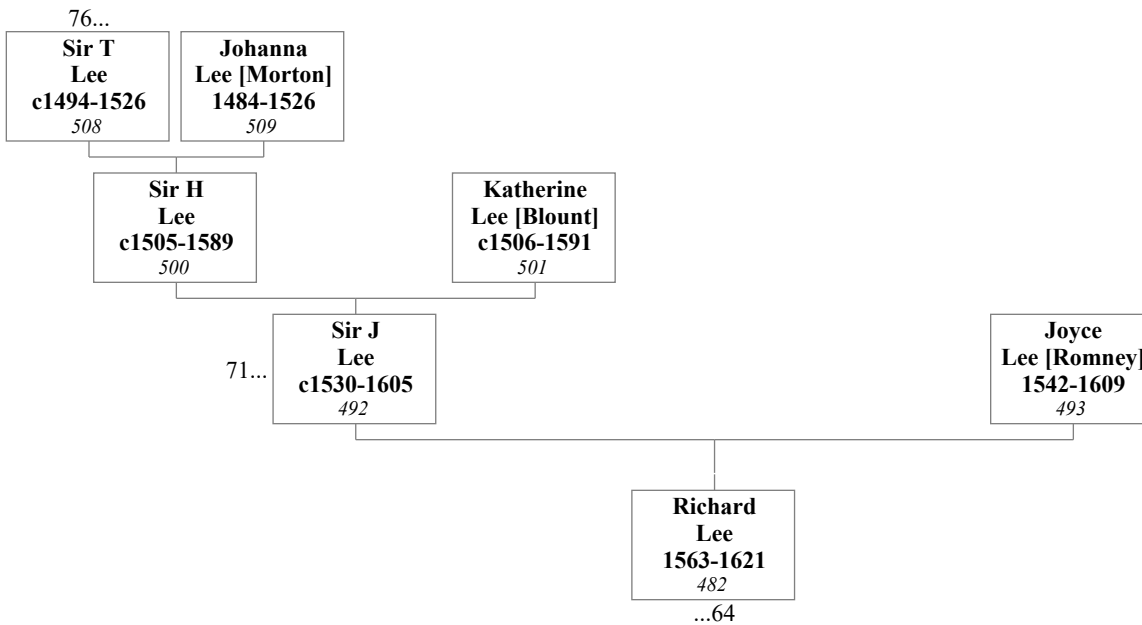

69. Edward Brett and Cissely Brett [Fitton]

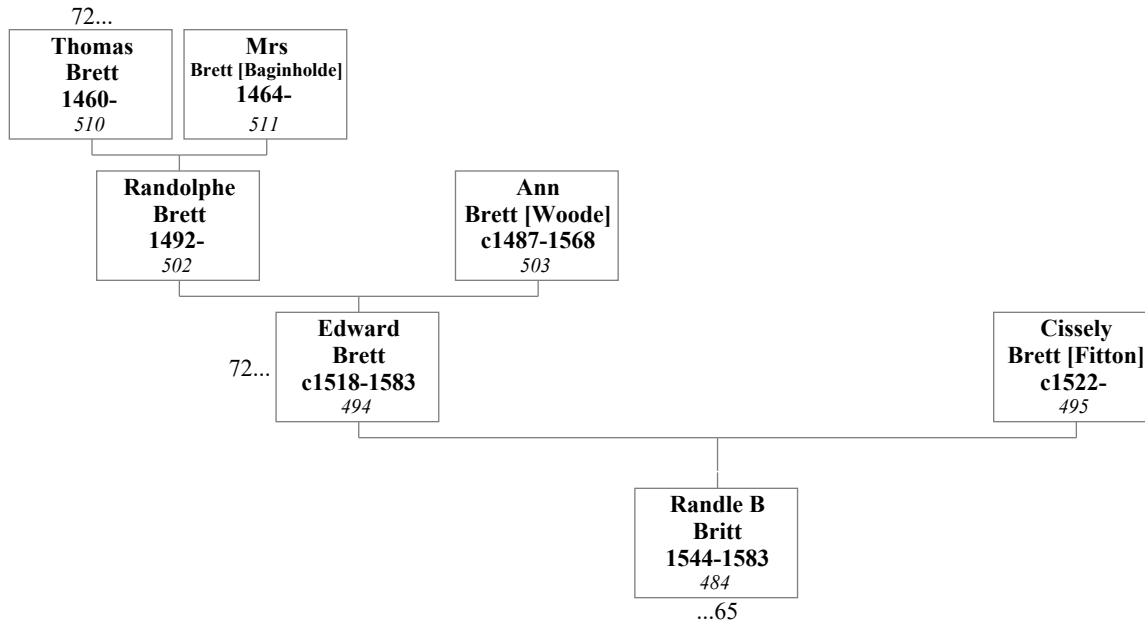

70. Louis Claude DuPre II and Suzanne DuPre [Moeze]

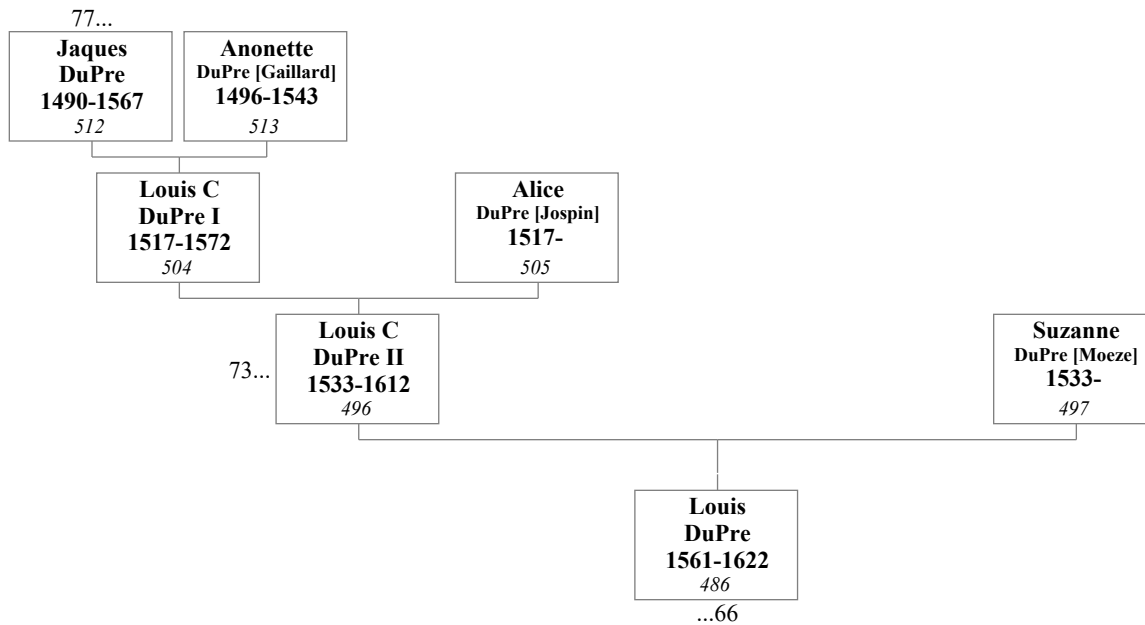

71. Sir Humphrey "Humphrey De Lee" Lee and Katherine Lee [Blount]

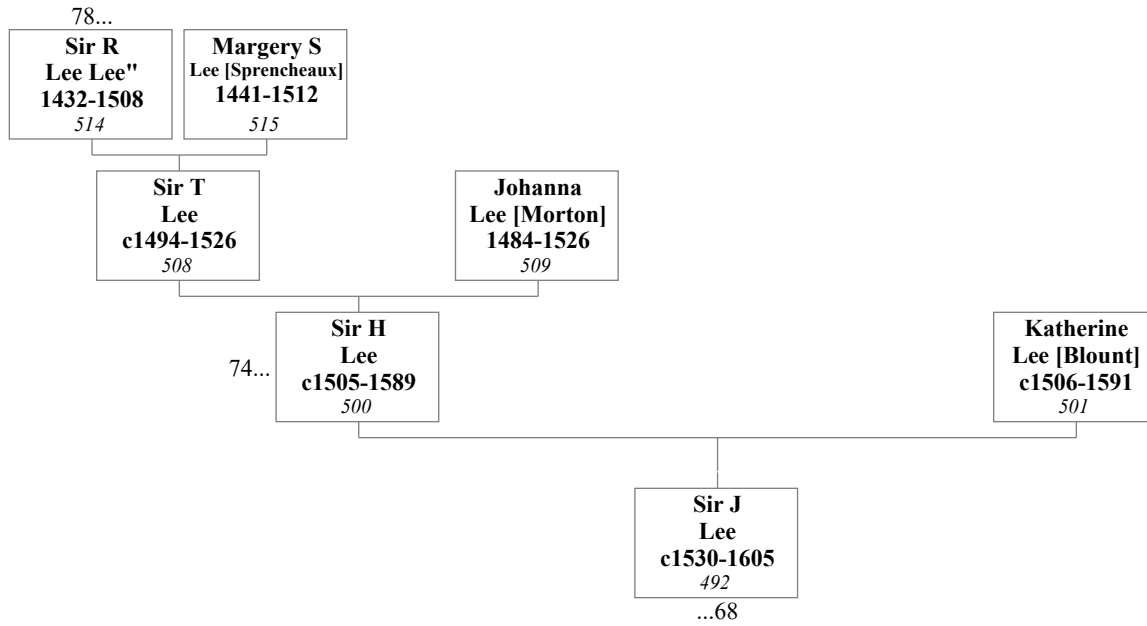

72. Randolphe Brett and Ann Brett [Woode]

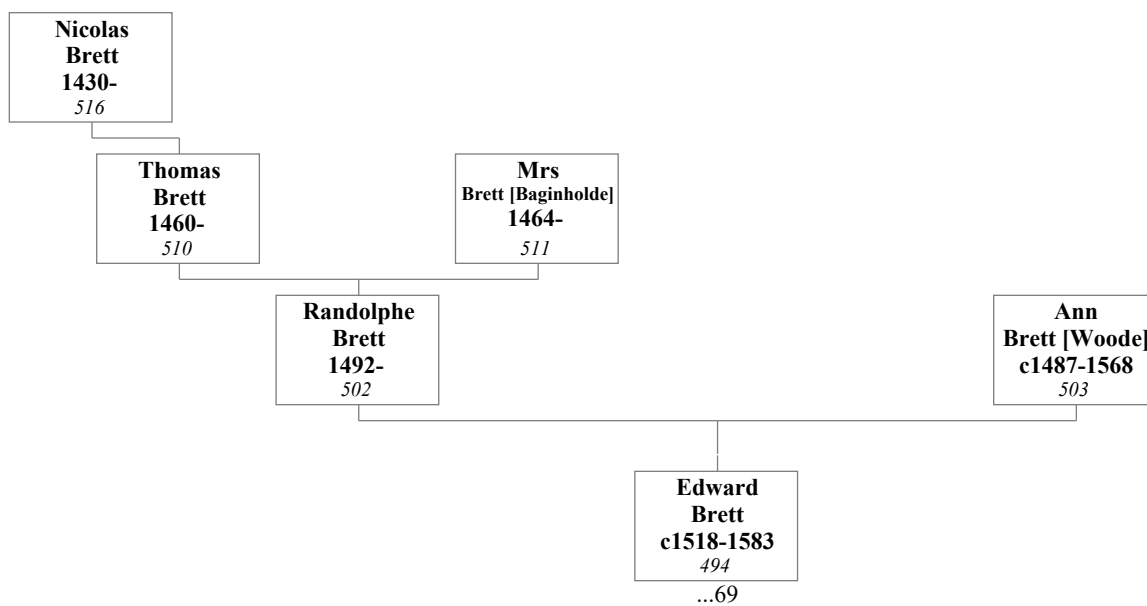

73. Louis Claude DuPre I and Alice DuPre [Jospin]

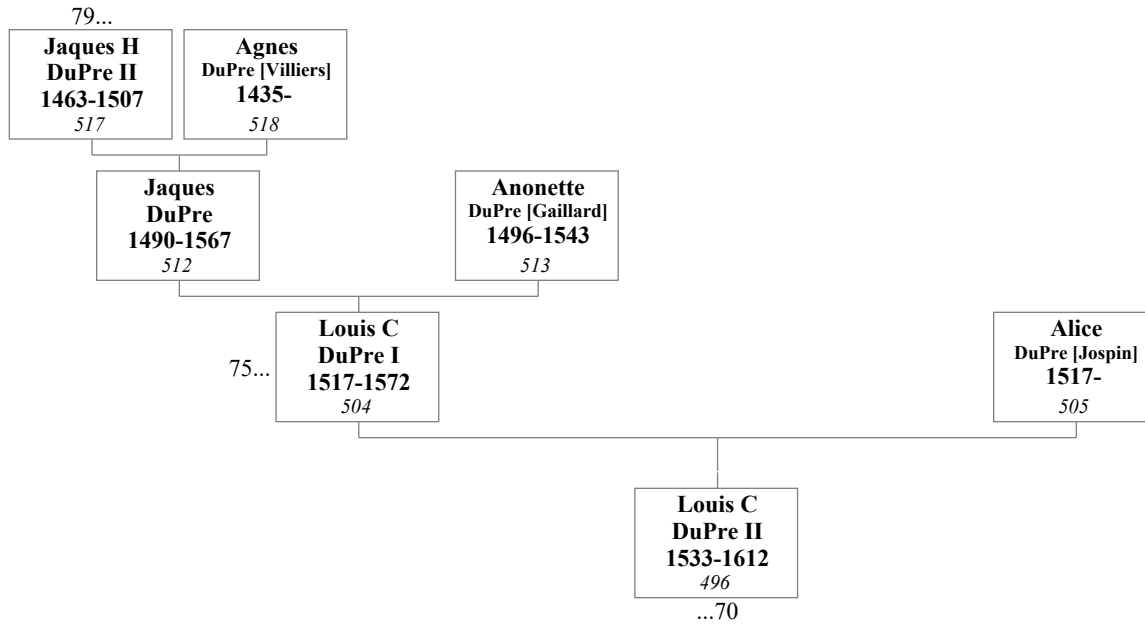

74. Sir Thomas Lee and Johanna Lee [Morton]

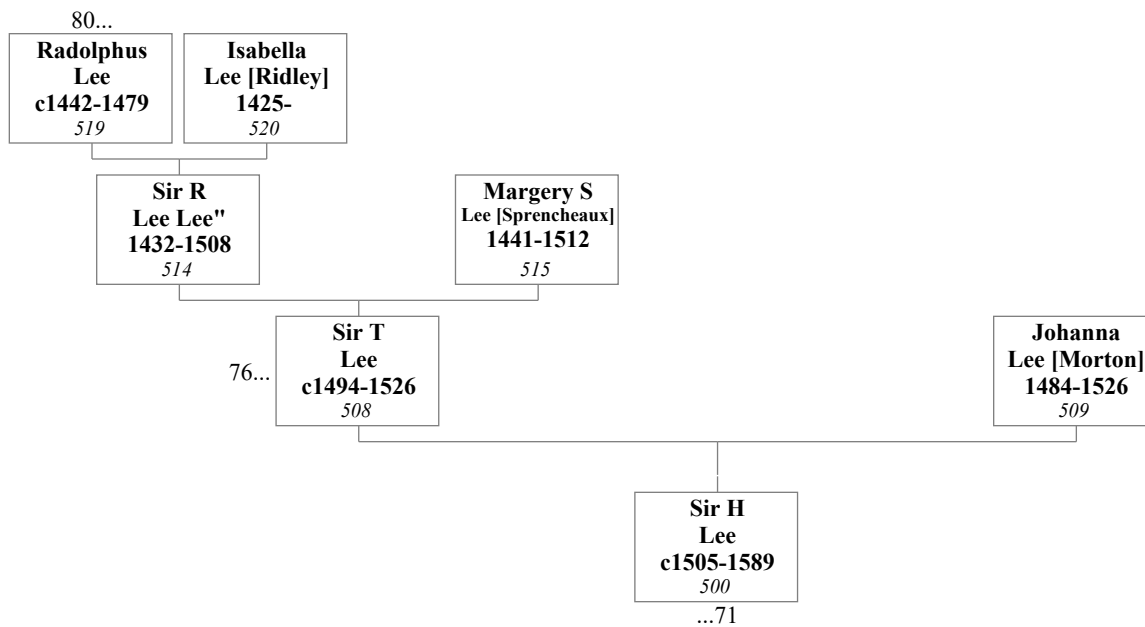

75. Jaques "James" Henre DuPre and Anonette DuPre [Gaillard]

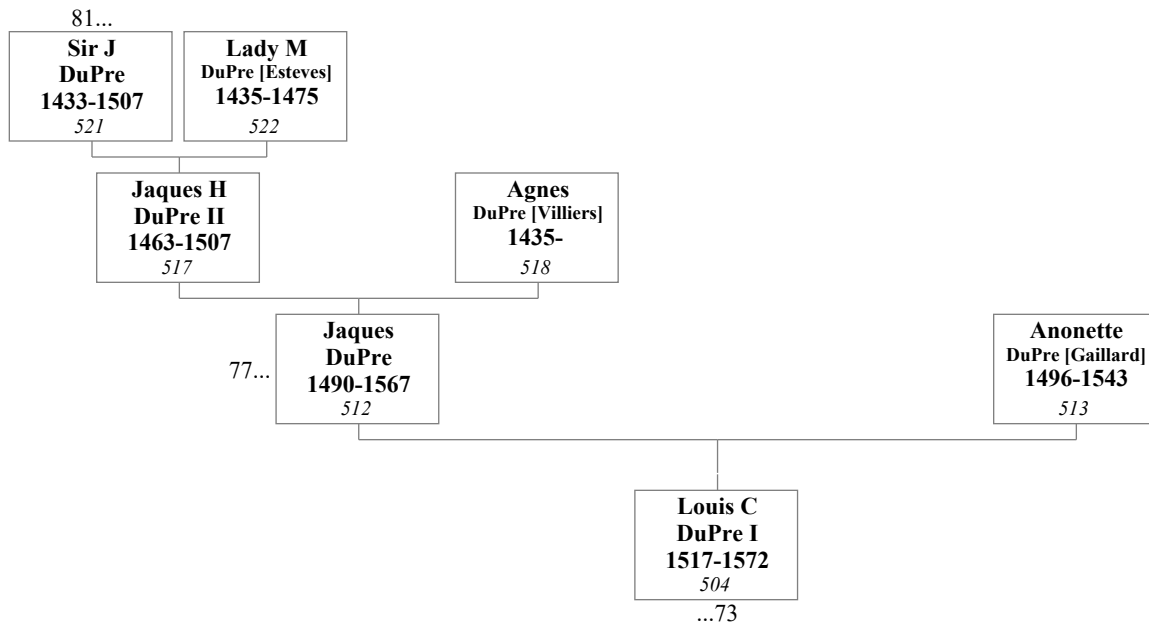

76. Sir Richard "Recardus /De Lee/Lee" Lee Lee" and Margery Sprenceaux Lee [Sprenceaux]

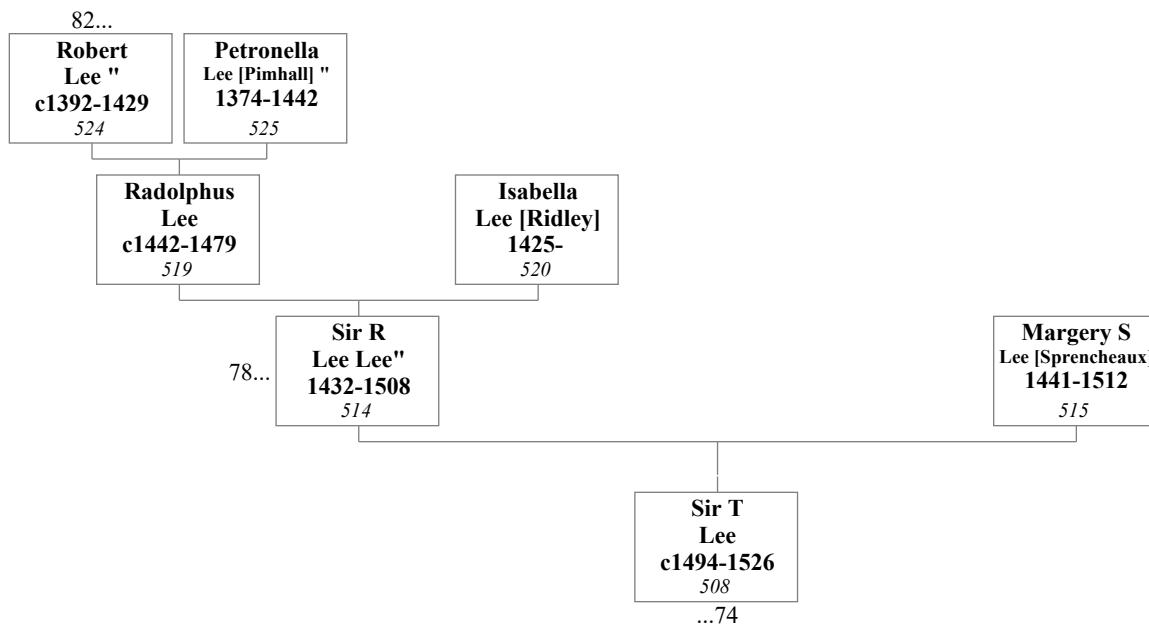

77. Jaques Henre DuPre II and Agnes DuPre [Villiers]

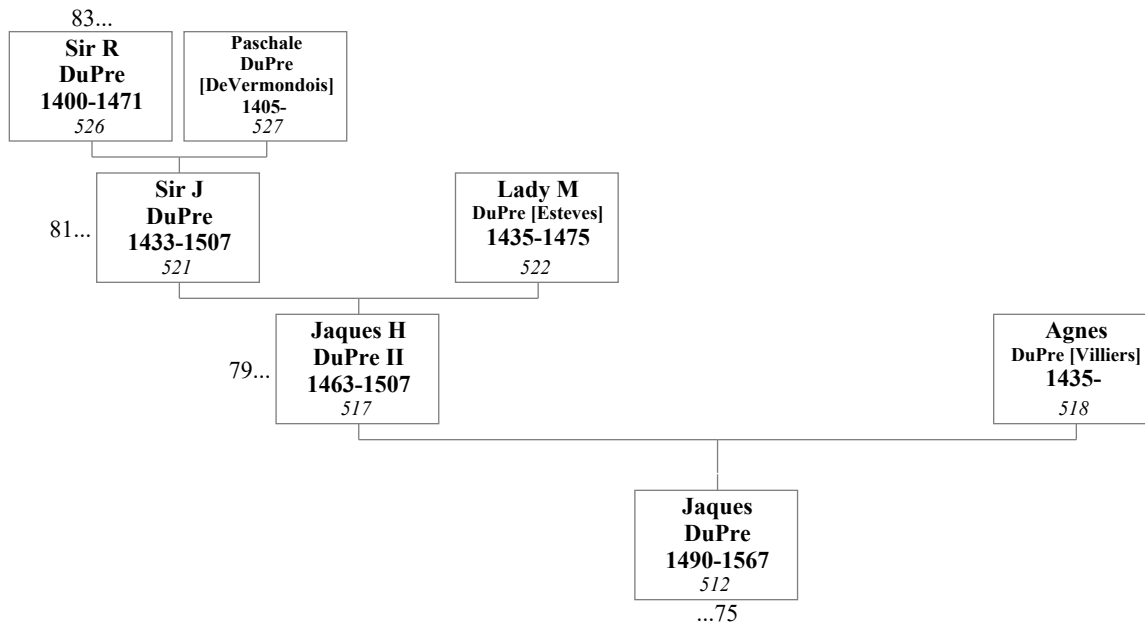

78. Radolphus "Ralph de Lee" Lee and Isabella Lee [Ridley]

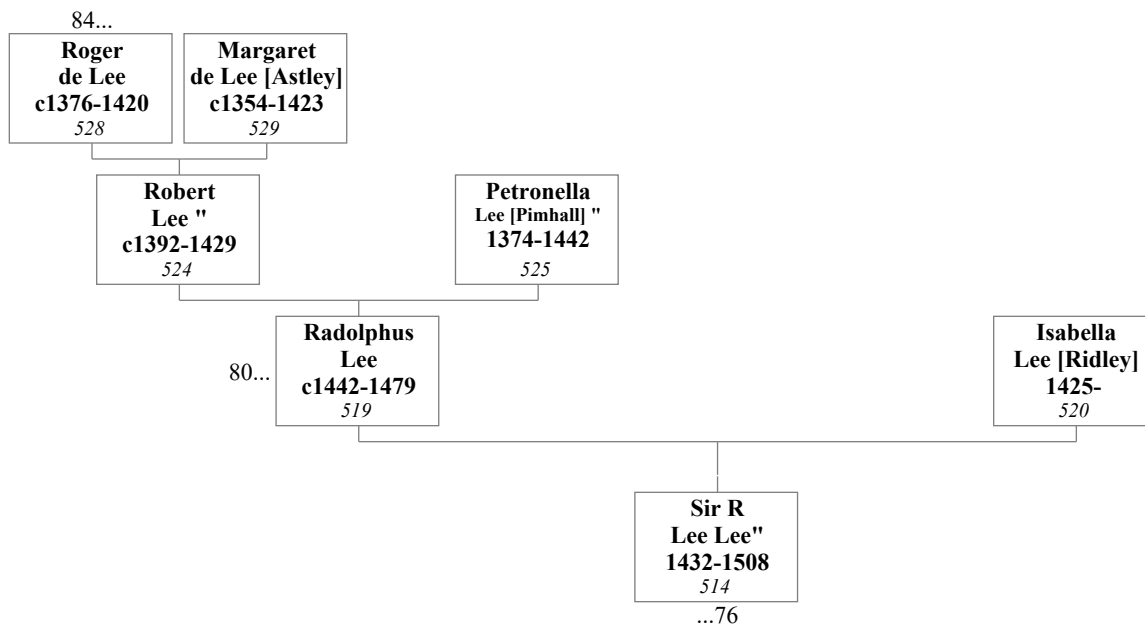

79. Sir Josias DuPre and Lady Maria DuPre [Esteves]

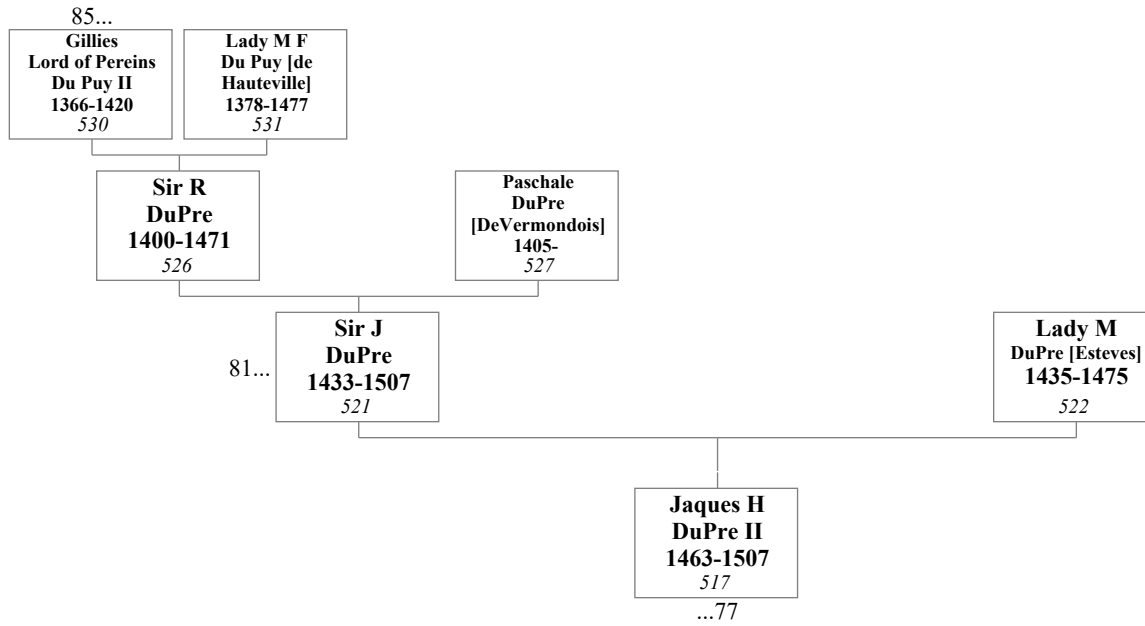

80. Robert "Robert /De Lee/" Lee " and Petronella "Petronilla Of Lampley /De Lee/" Lee [Pimhall] "

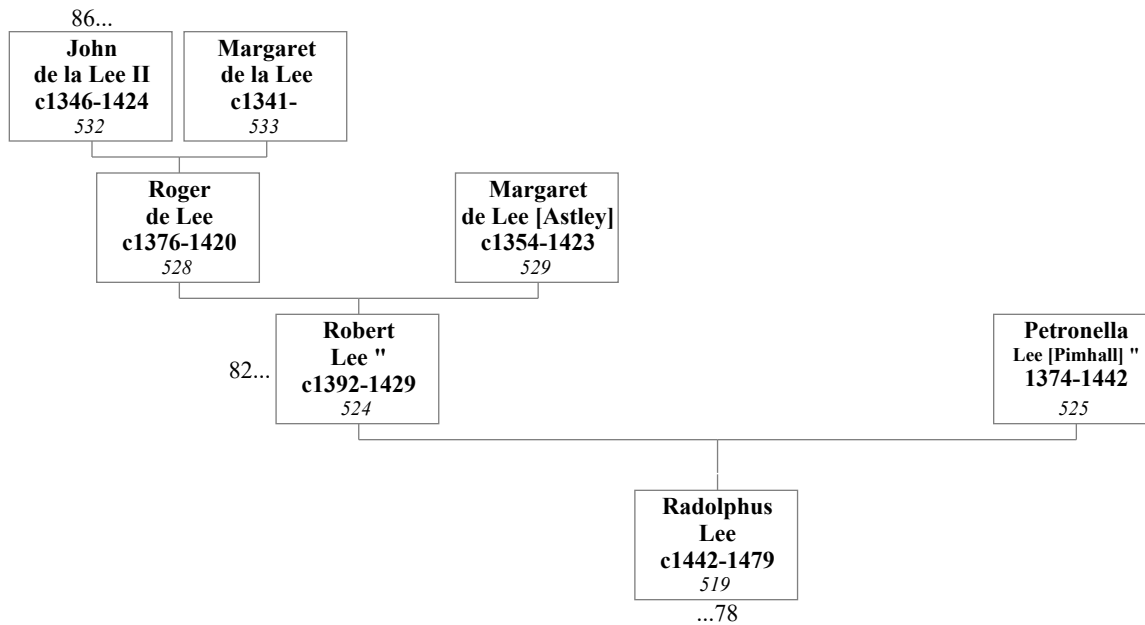

81. Sir Richard DuPre and Paschale DuPre [DeVermondois]

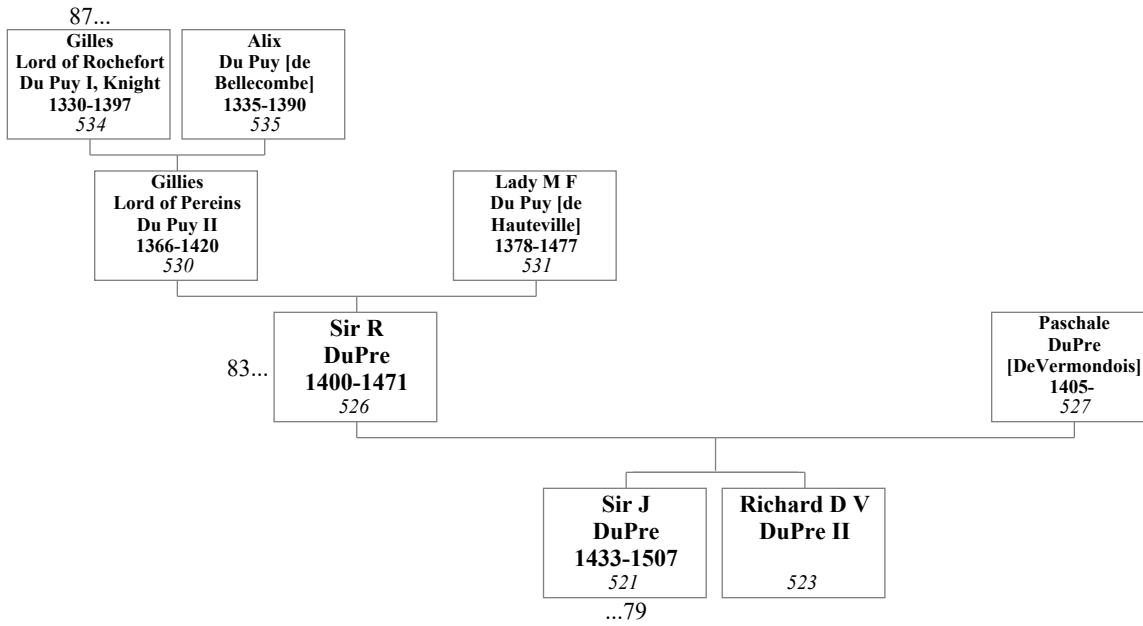

82. Roger "Robert" de Lee and Margaret "Margaret de Astley" de Lee [Astley]

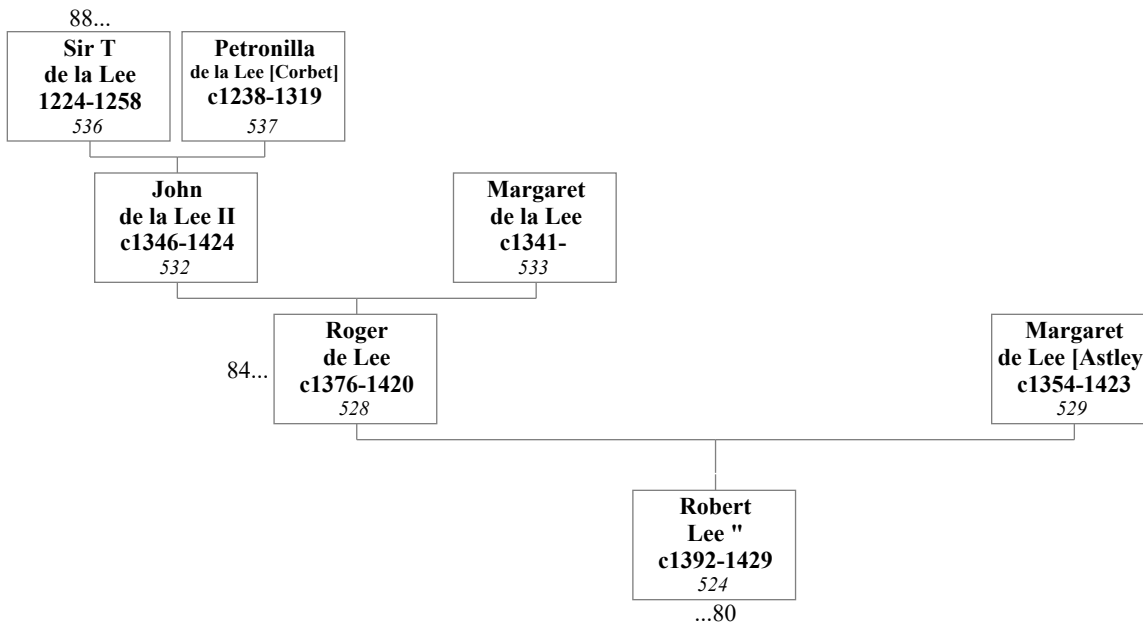

83. Gillies Lord of Pereins Du Puy II and Lady Marie Florence Du Puy [de Hauteville]

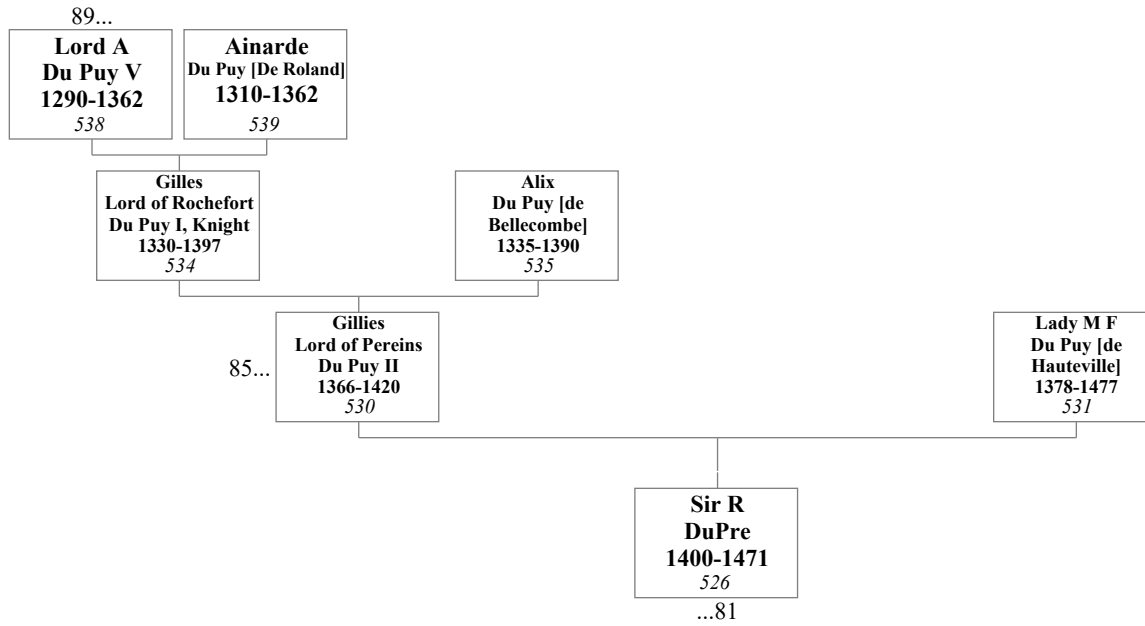

84. John de la Lee II and Margaret de la Lee

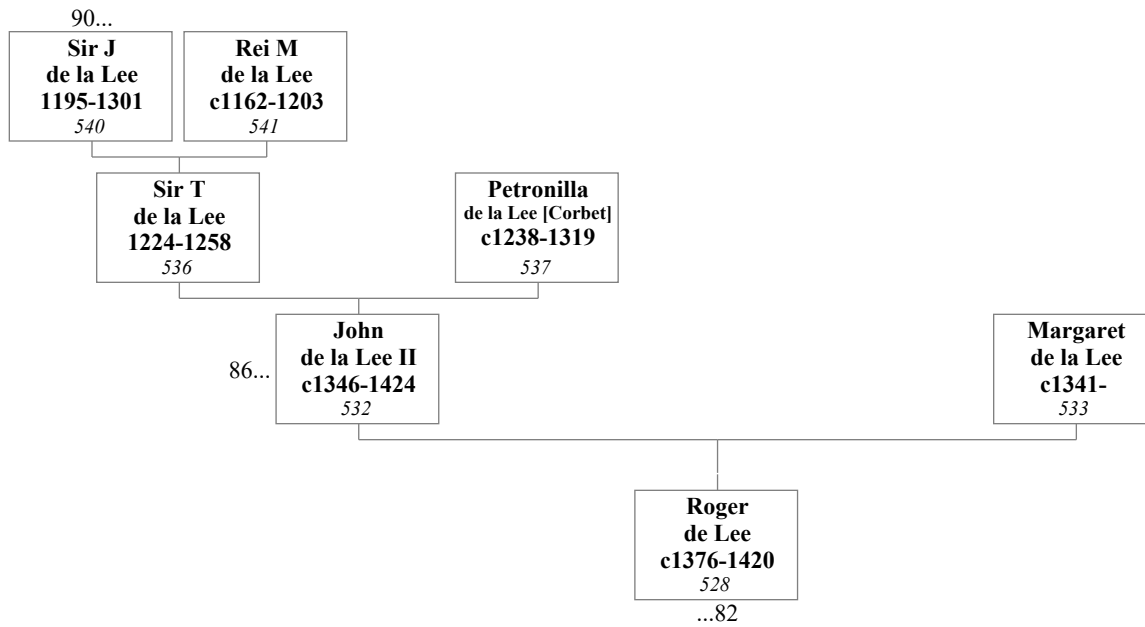

85. Gilles Lord of Rochefort Du Puy I, Knight and Alix Du Puy [de Bellecombe]

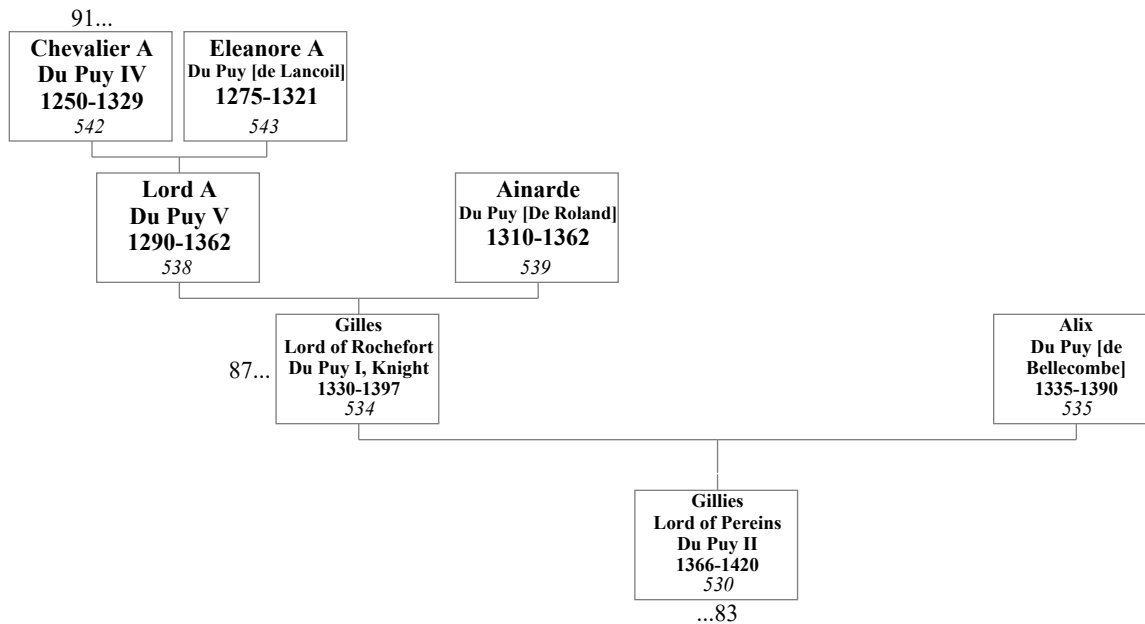

86. Sir Thomas de la Lee and Petronilla de la Lee [Corbet]

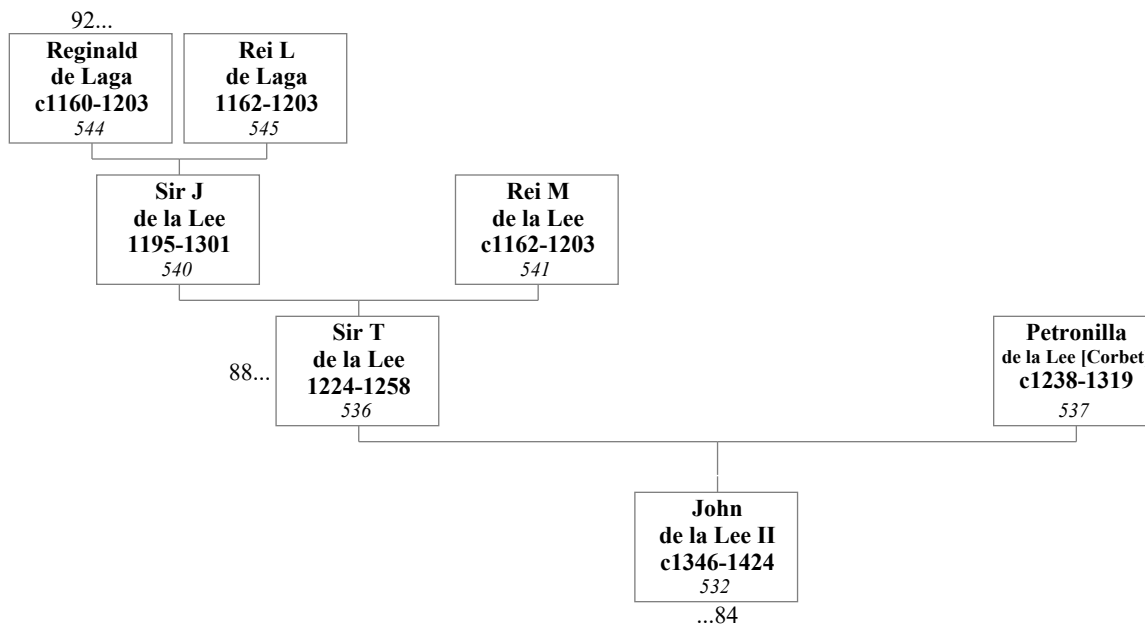

87. Lord Alleman Du Puy V and Ainarde Du Puy [De Roland]

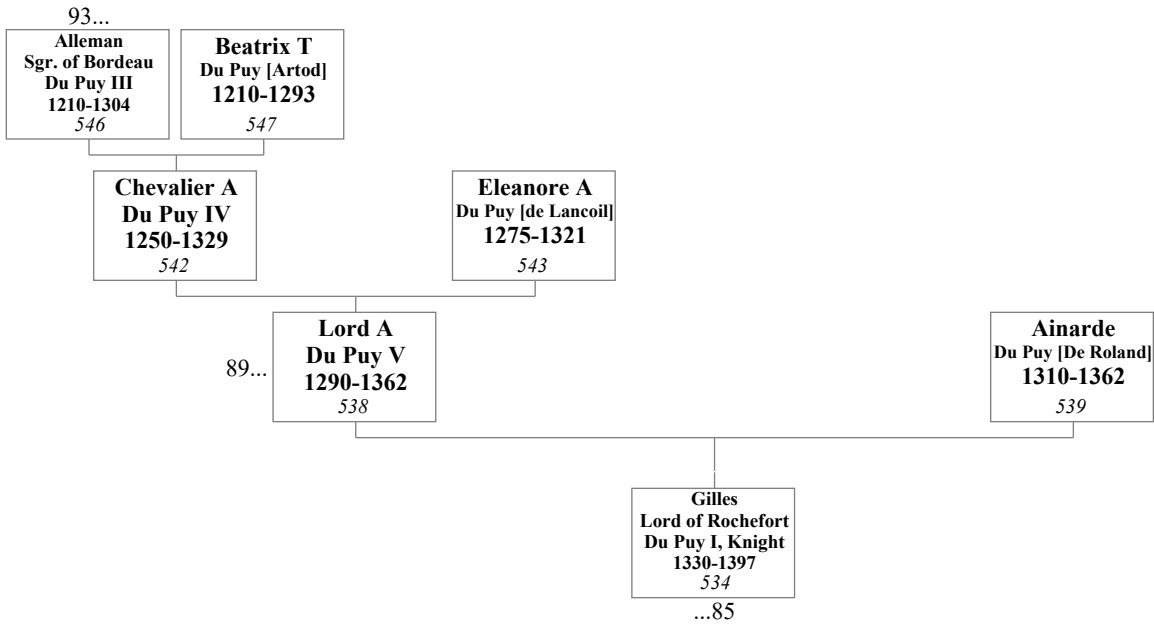

88. Sir John "John Lee Esquire" de la Lee and Rei Mnu de la Lee

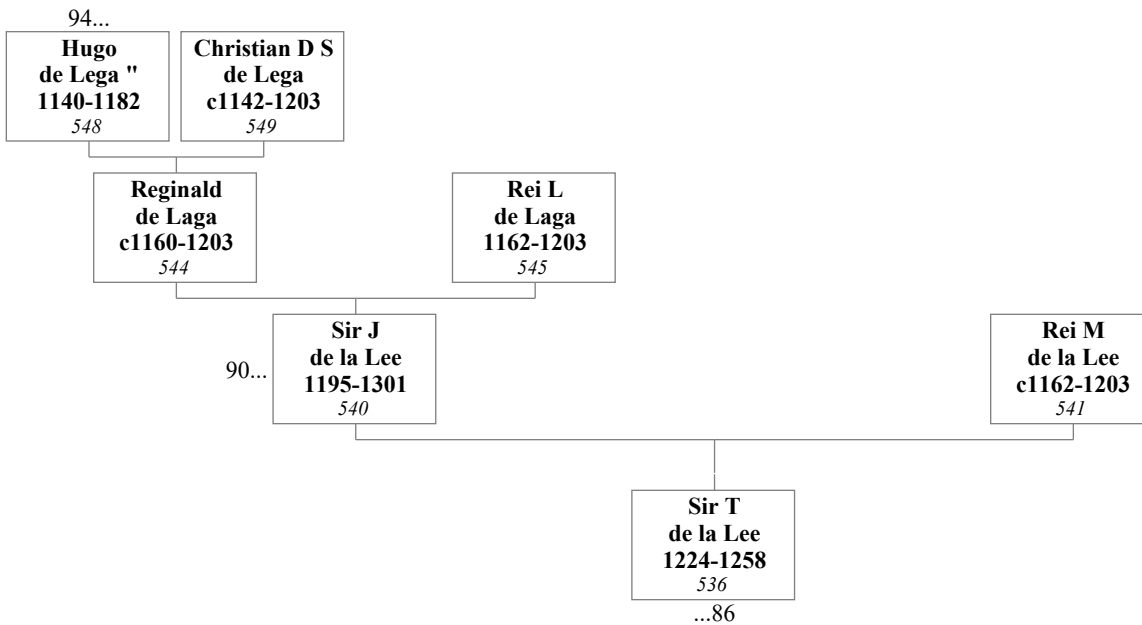

89. Chevalier Alleman Du Puy IV and Eleanore Alleman Du Puy [de Lancoil]

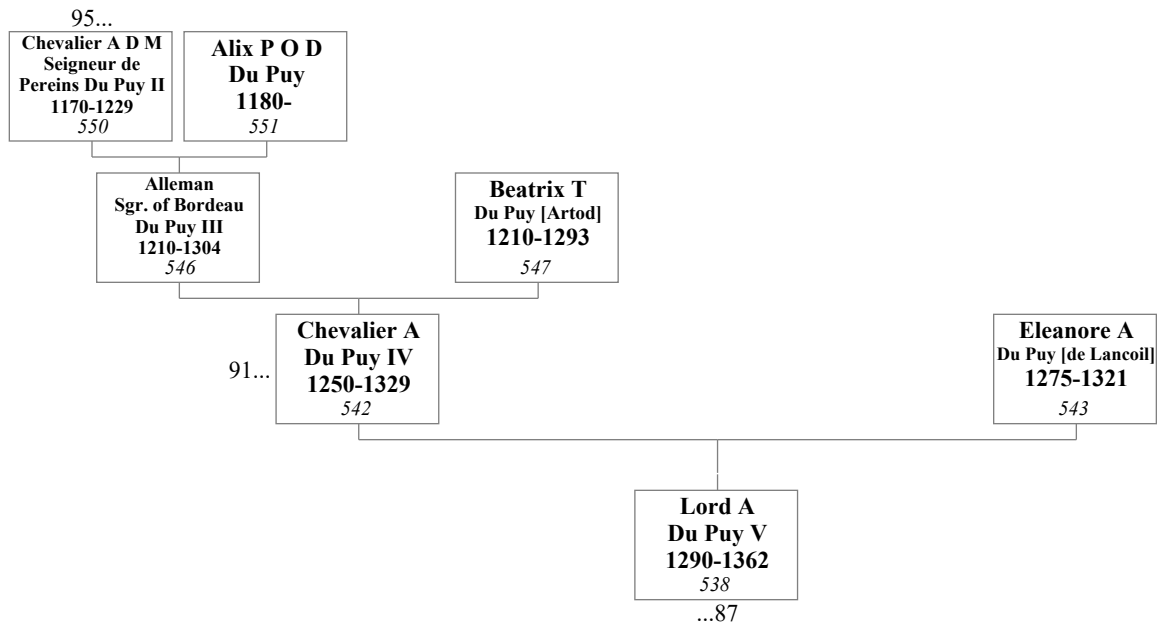

90. Reginald "Reginald Reynor de la Lea" de Laga and Rei Lega de Laga

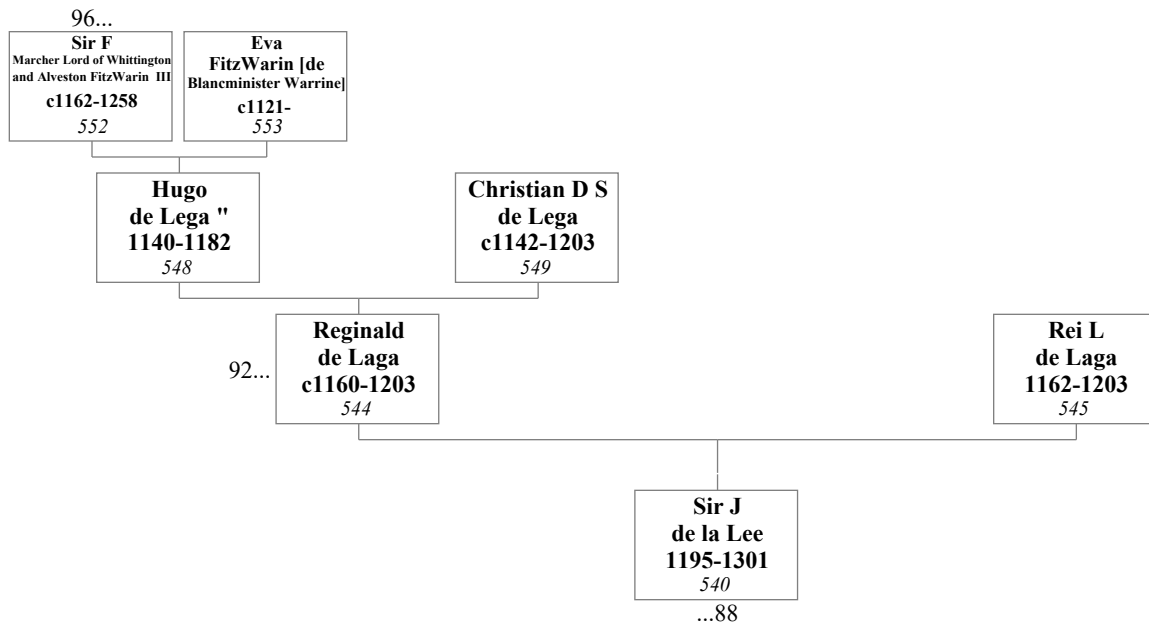

91. Alleman Sgr. of Bordeau Du Puy III and Beatrix Tournon Du Puy [Artod]

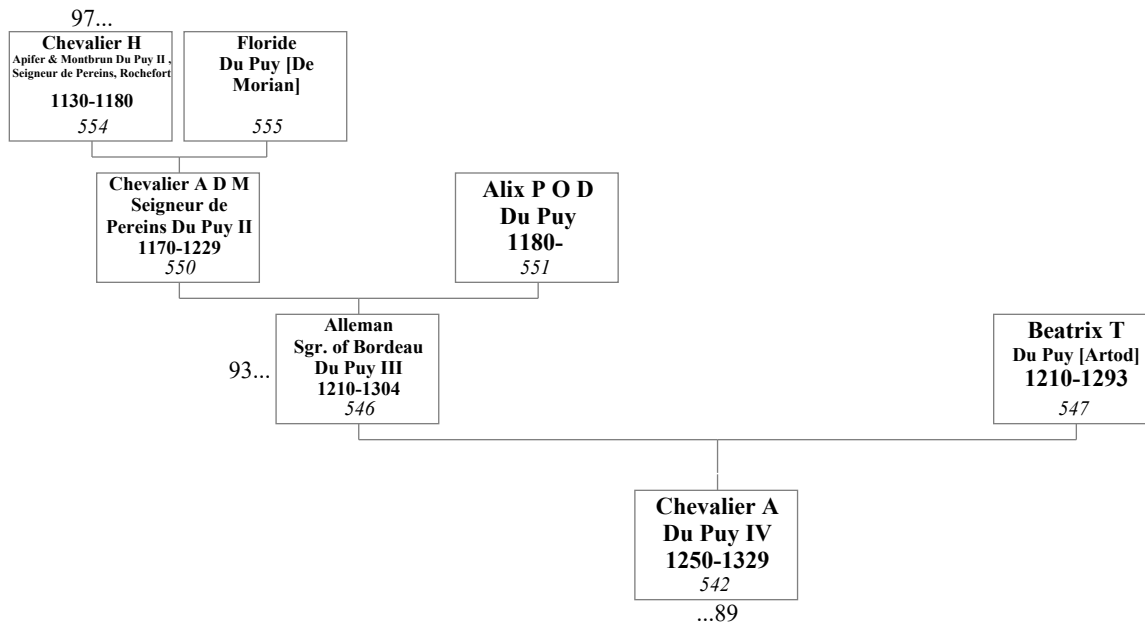

92. Hugo "Hugo de La Lea /de Lee/" de Lega " and Christian De Stainton de Lega

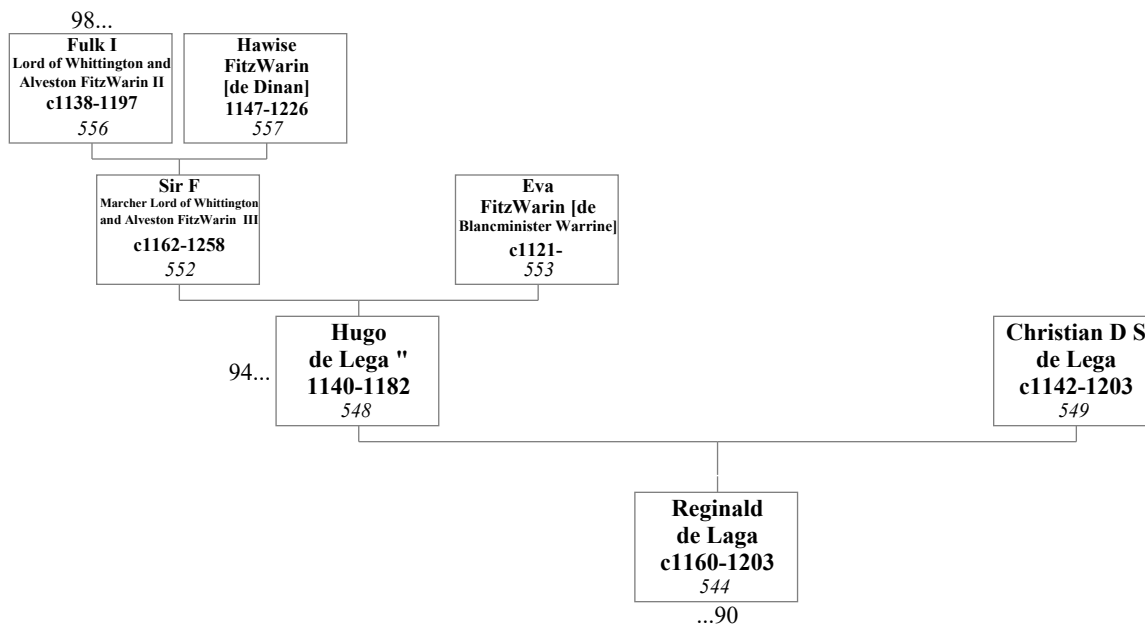

93. Chevalier Alleman de Montbrun Seigneur de Pereins Du Puy II and Alix Princess of Dauphine Du Puy

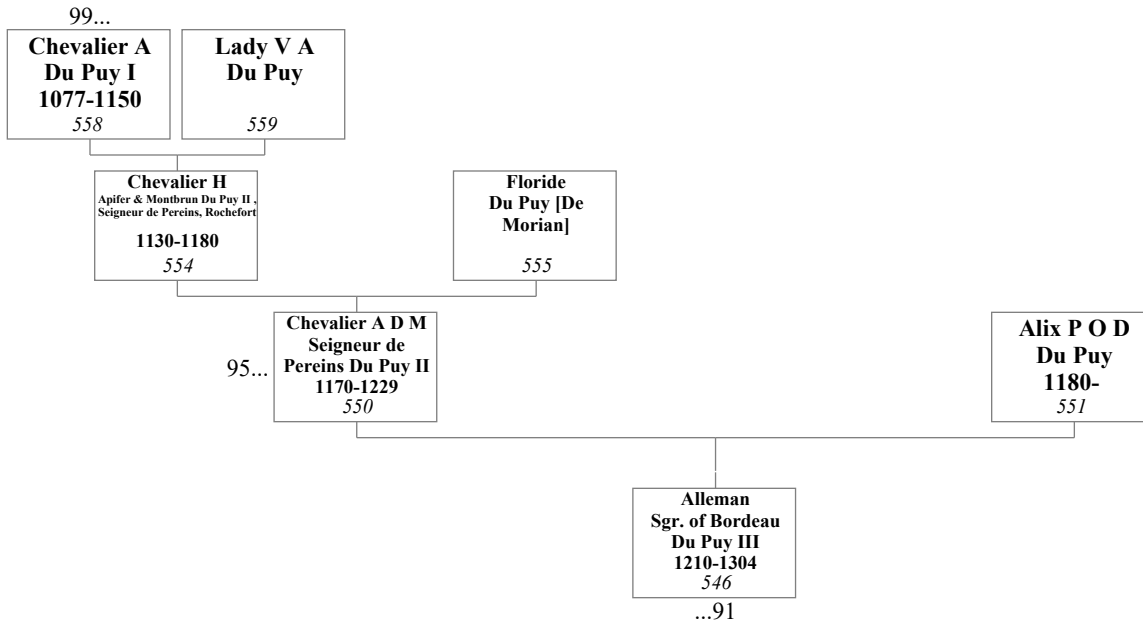

94. Sir Fulk Marcher Lord of Whittington and Alveston FitzWarin III and Eva FitzWarin [de Blancminister Warrine]

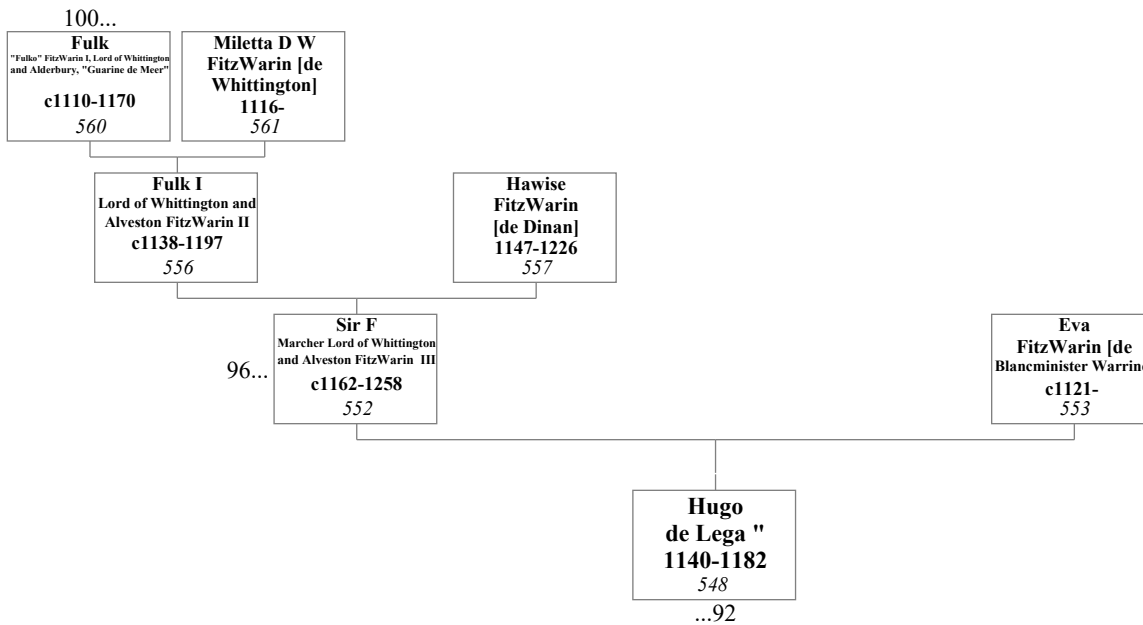

95. Chevalier Hugues Apifer & Montbrun Du Puy II , Seigneur de Pereins, Rochefort and Floride Du Puy [De Morian]

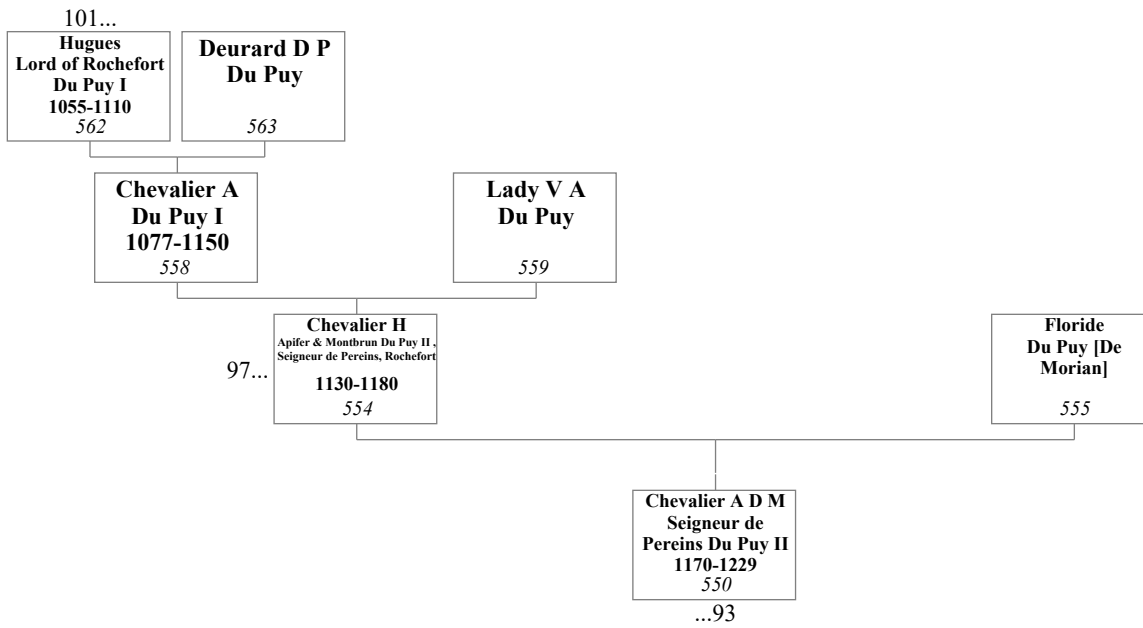

96. Fulk II "Brunin" Lord of Whittington and Alveston FitzWarin II and Hawise FitzWarin [de Dinan]

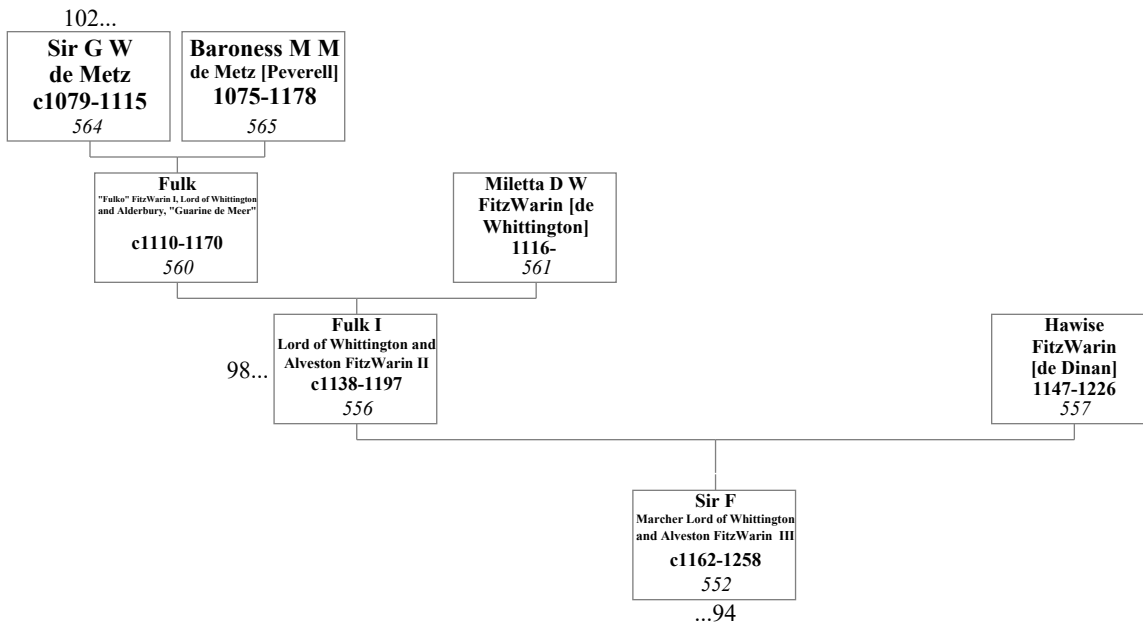

97. Chevalier Alleman Du Puy I and Lady Veronique Ademar Du Puy

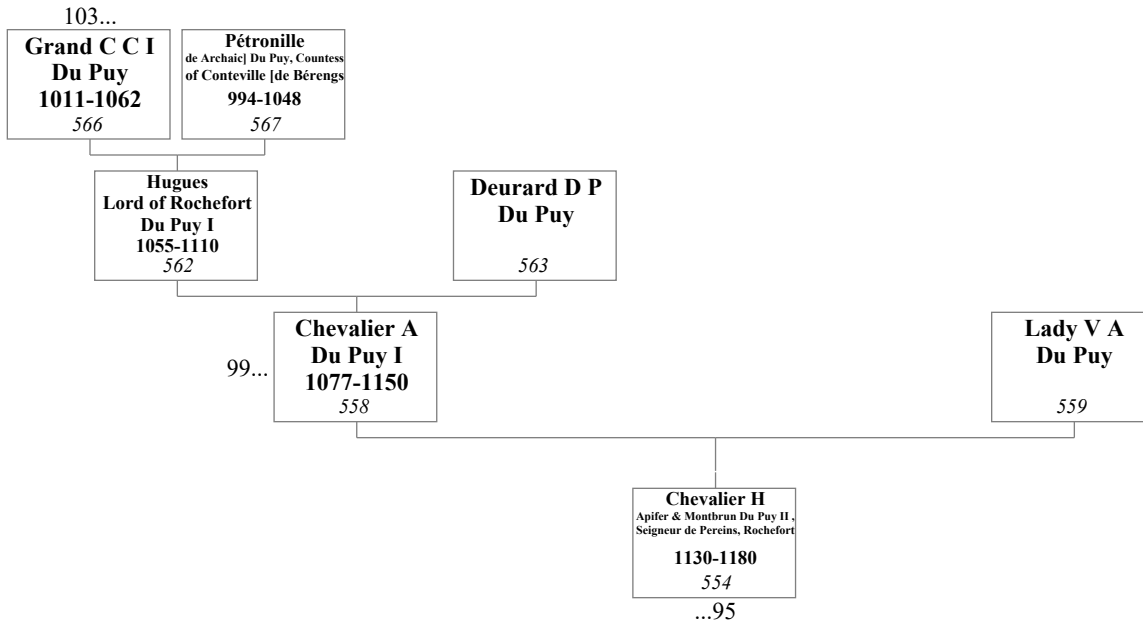

98. Fulko "Fulko" FitzWarin I, Lord of Whittington and Alderbury, "Guarine de Meer" and Miletta de Whittington FitzWarin [de Whittington]

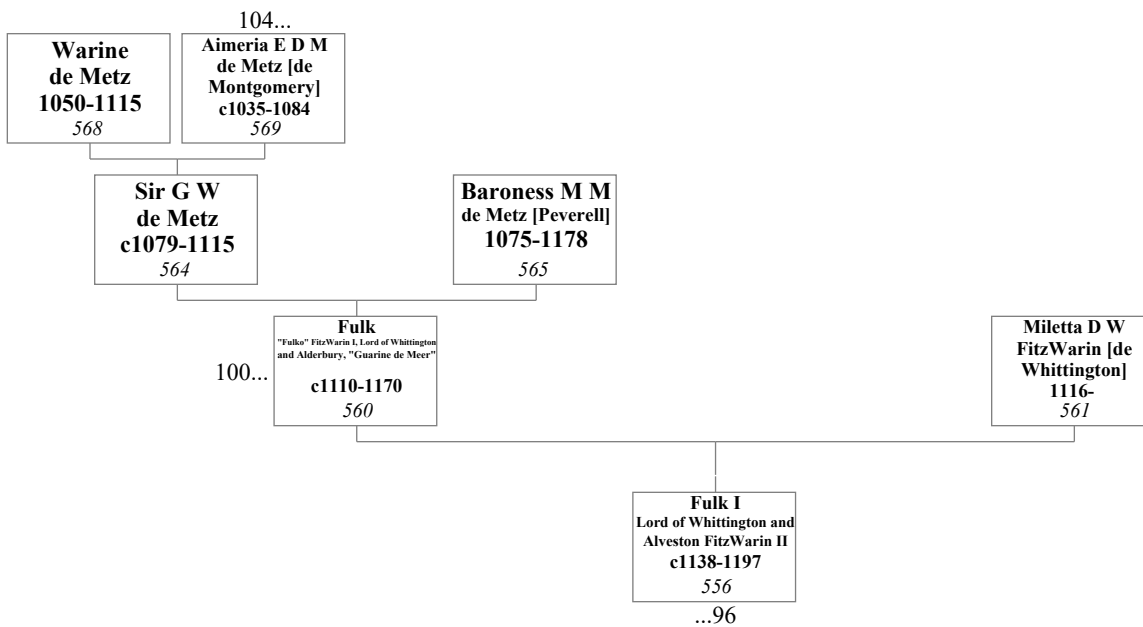

99. Hugues Lord of Rochefort Du Puy I and Deurard DE POISIEU Du Puy

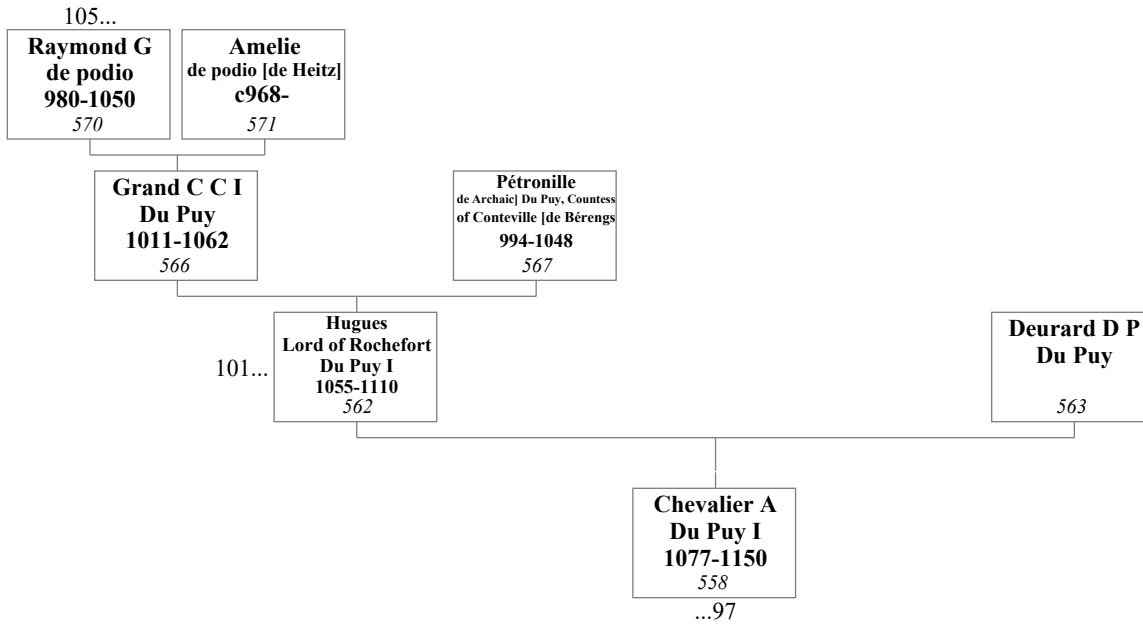

100. Sir Guy Warin "the Bold" de Metz and Baroness Melette Maud ,Heiress of Whittington, "Maud de Ingelrica" de Metz [Peverell]

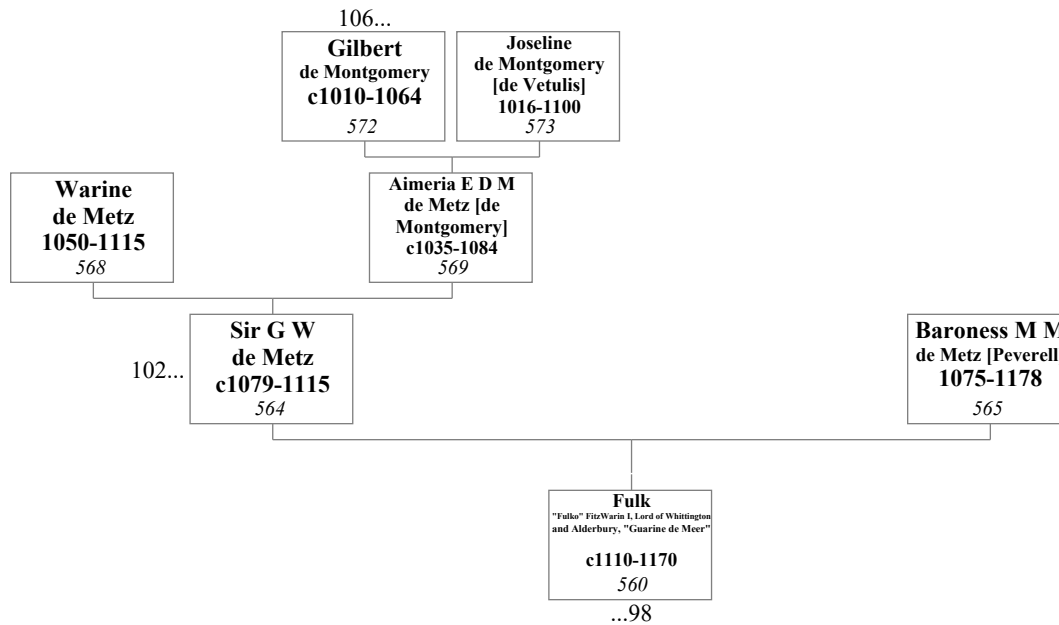

101. Grand Chamberlain Conrad II Raphael (del Poggio) Du Puy and Pétronille de Archaic] Du Puy, Countess of Conteville [de Bérengs

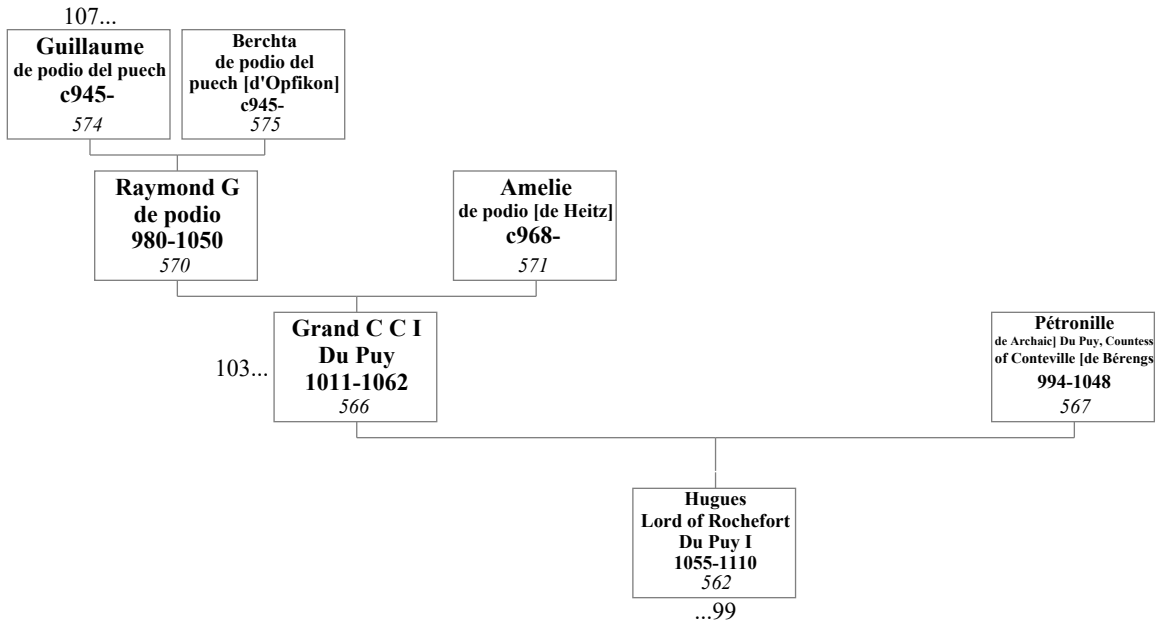

102. Warine "The Sherriff" de Metz and Aimeria Emma de Montgomery de Metz [de Montgomery]

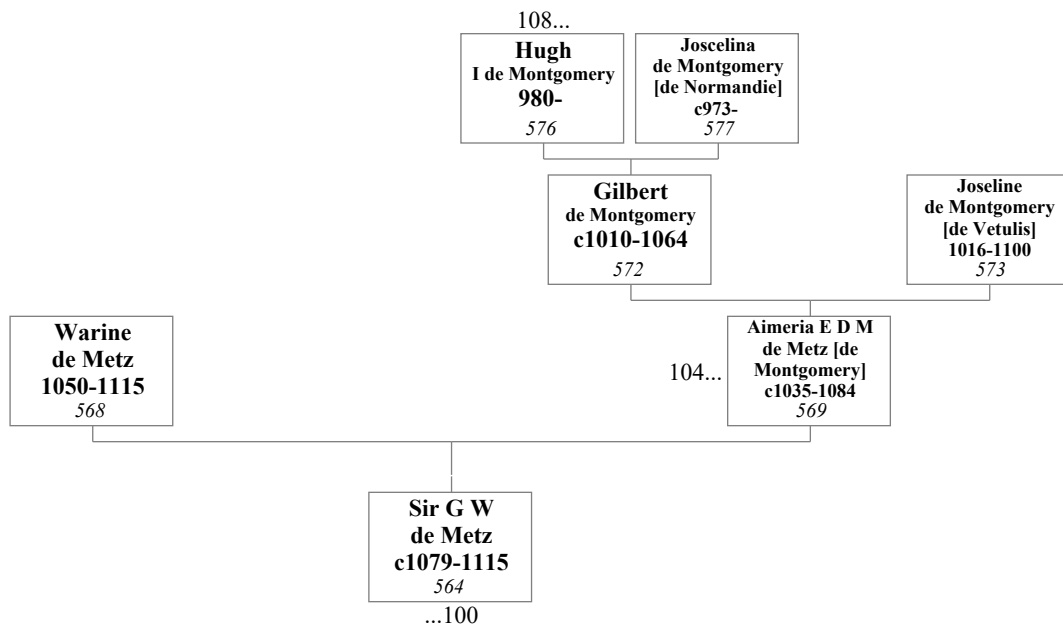

103. Raymond Guillaume de podio and Amelie de podio [de Heitz]

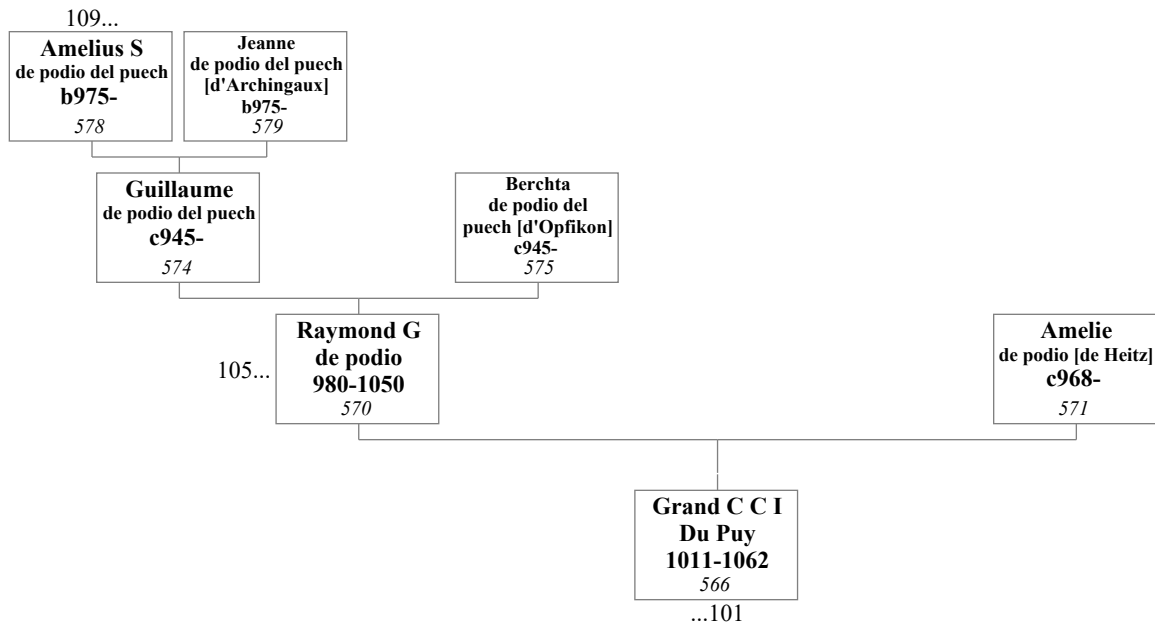

104. Gilbert de Montgomery and Joseline de Montgomery [de Vetulis]

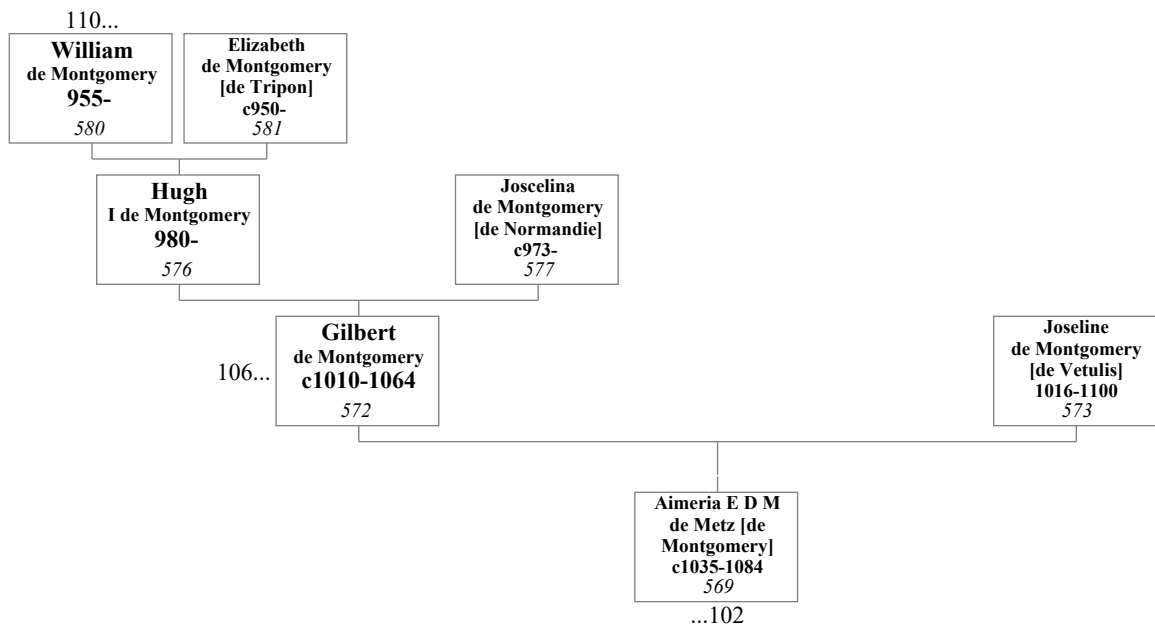

105. Guillaume de podio del puech and Berchta de podio del puech [d'Opfikon]

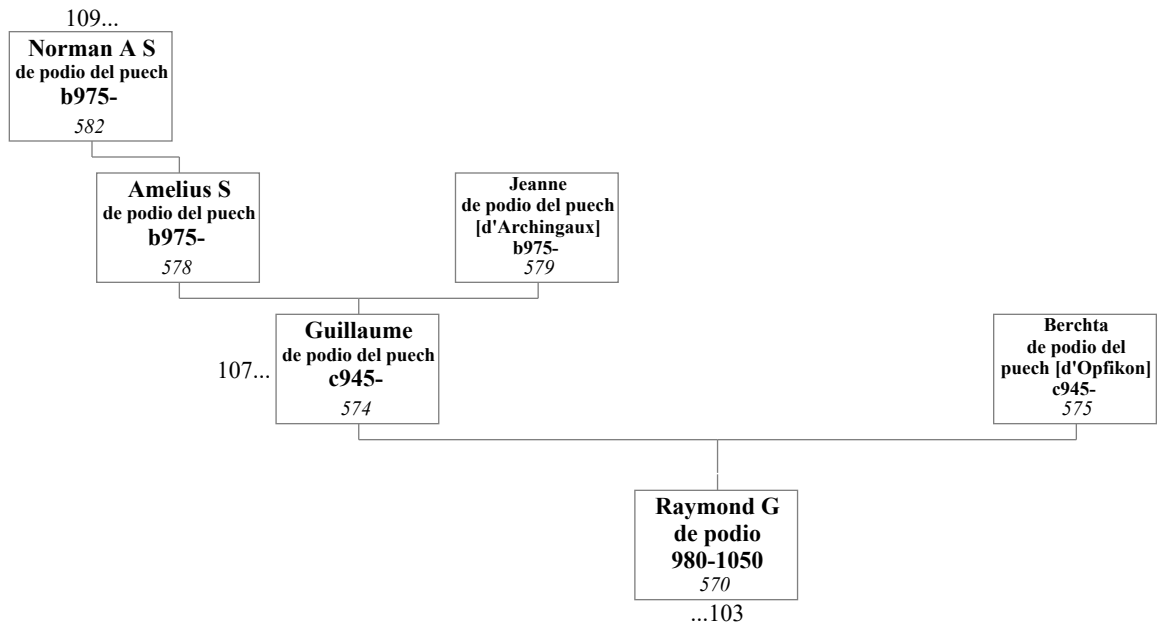

106. Hugh I de Montgomery and Joscelina de Montgomery [de Normandie]

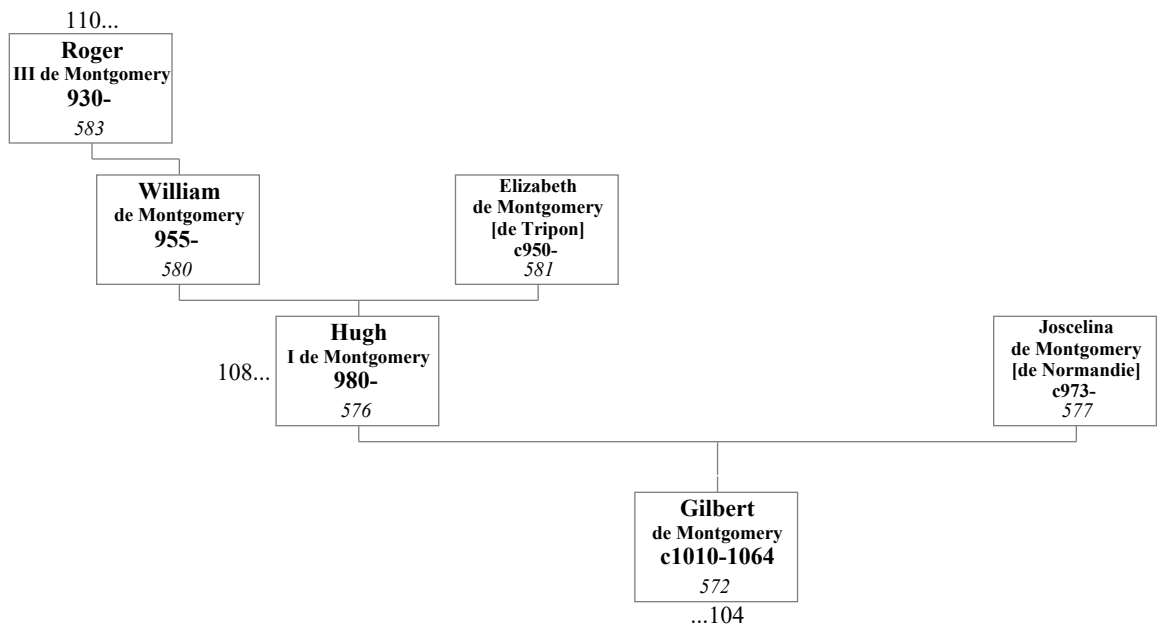

107. Amelius Simplious (de Pugio) de podio del puech and Jeanne de podio del puech [d'Archingaux]

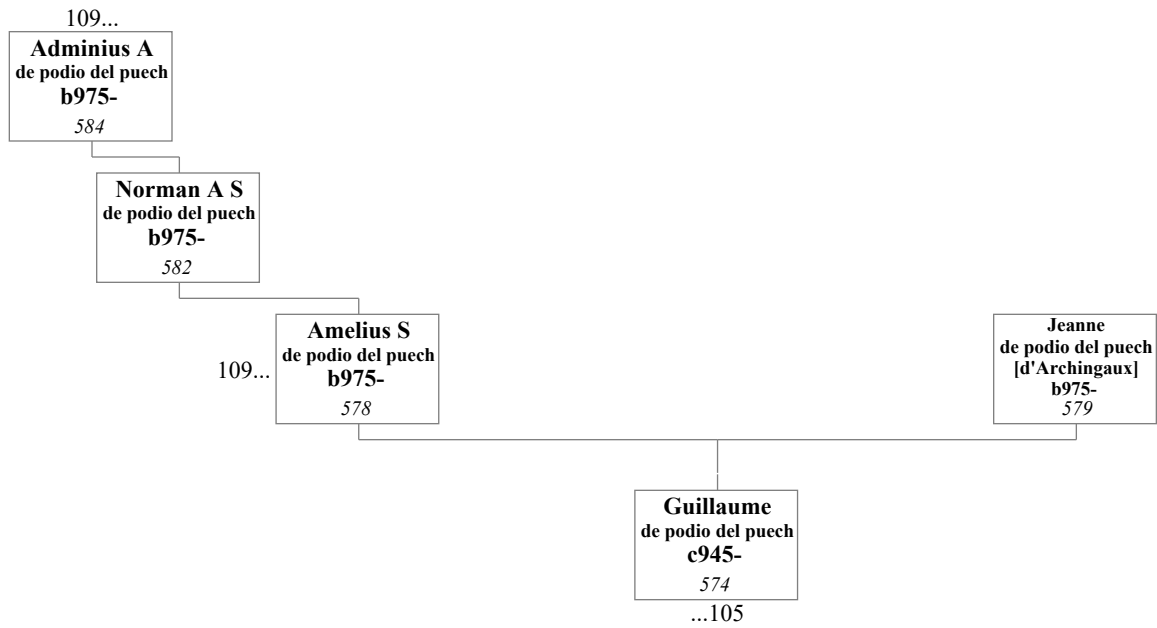

108. William de Montgomery and Elizabeth de Montgomery [de Tripon]

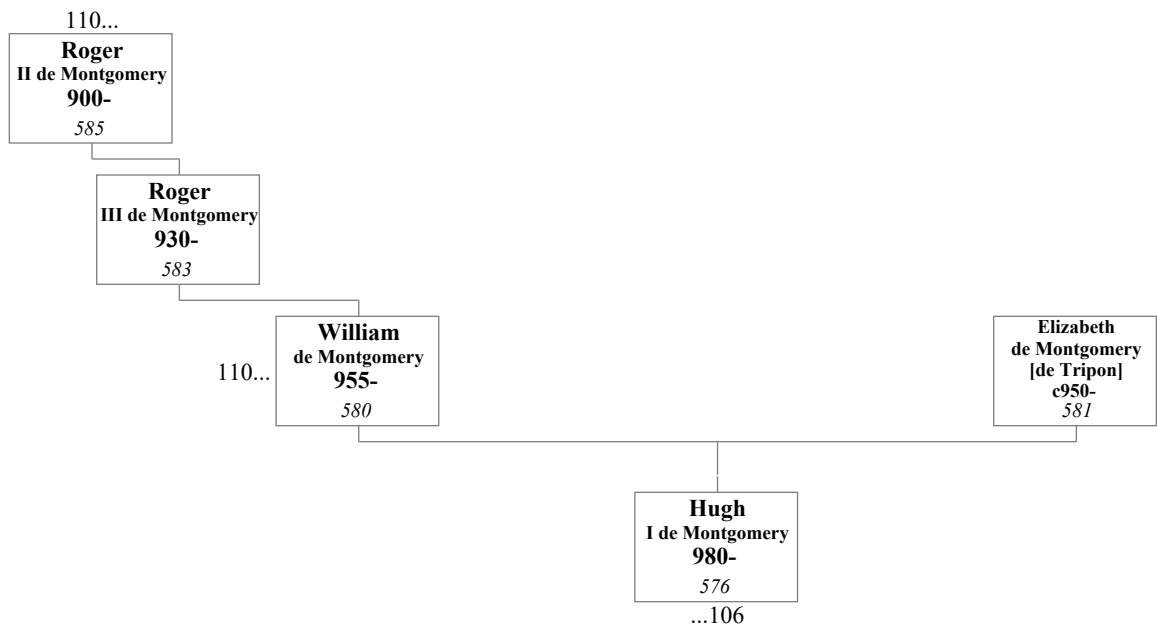

109. Norman Anglo saxony (de Pugio) de podio del puech

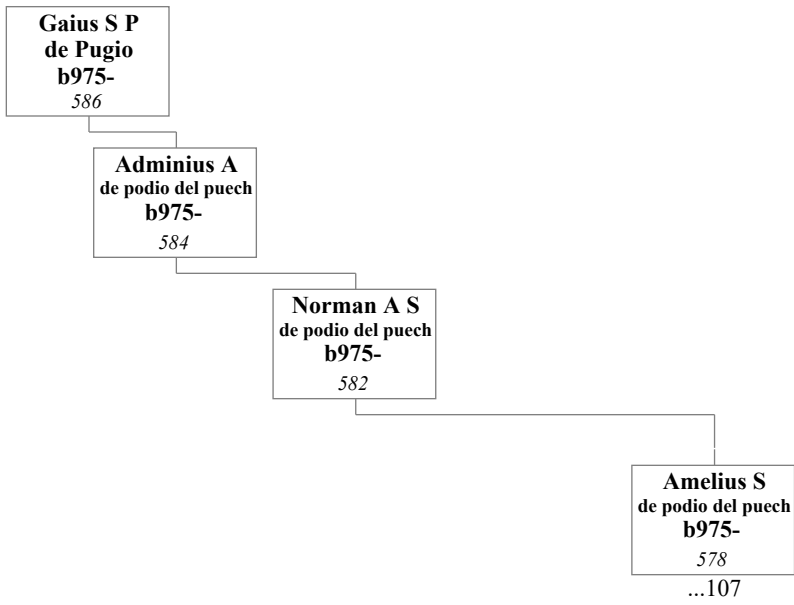

110. Roger III de Montgomery

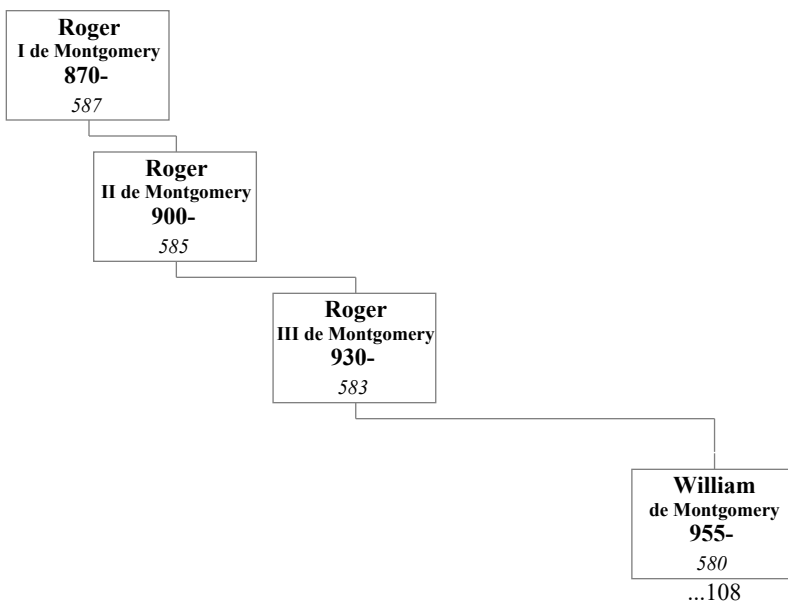

15. NOTES

1. This Family Cemetery is no longer in use and is located on Tryon Rd {6051}. It is adjacent to the cemetery at Colonial Baptist Church, but is not part of the church cemetery. *Applies to: James Leslie Franks²⁹¹; James "Jim" David Franks³⁴⁰.*

16. INDEX OF PLACES

Residence of Willis L. Woodall²⁷⁰ at Smithfield, NC.

ANGIER PRIMITIVE BAPTIST CHURCH CEMETERY

Burial of Eira Watkins [Taylor]²³⁶.

ARKANSAS

Death of Henry "Harry" Lee³³⁰ in 1860.

AT SONS HOME

Death of Bonnie Lou Poole [Watkins]¹⁶³ on 25 March 2017.

CONNECTICUT, WINDHAM COUNTY, CANTERBURY

Birth of Joseph Britt³⁷⁵ on 16 June 1731.

CREMATED

Burial of Harry Clay Dupree²⁵⁹.

Burial of Gregory Wayne Pumroy⁶⁰⁶.

Burial of Bonnie Lou Poole [Watkins]¹⁶³.

Burial of Bill Ulysses Davis¹¹⁴.

Burial of Betty Jean "BJ" Moore [Wilson]⁶¹⁶.

Burial of Nancy Carol Moore [Washington]⁶¹⁹.

Burial of Roy Neal Moore Jr.⁶¹⁵.

ENGLAND , EAST LONDON, ST. DUNSTON

Marriage of Edward Mashborne Mashburn Sr.⁴³³ and Sarah Mashburn [Sindery]⁴³⁴ on 16 August 1676.

ENGLAND, BUCKINGHAMSHIRE, CHESHAM

Burial of Sir John "John Lee Esquire" Lee⁴⁹².

Burial of Richard Lee⁴⁸².

ENGLAND, BUCKINGHAMSHIRE, MILTON KEYNES

Birth of Laurence Woodall⁴⁸⁰ in 1500.

Birth of Agnes Woodall [Inu/Light] Light⁴⁸¹ in 1507.

ENGLAND, BUCKINGHAMSHIRE

Death of Laurence Woodall⁴⁸⁰ in 1556.

ENGLAND, CAMBRIDGESHIRE, BRUNNE

Birth of Baroness Melette Maud ,Heiress of Whittington, "Maud de Ingelrica" de Metz [Peverell]⁵⁶⁵ in 1075.

ENGLAND, CHESHIRE, LANGLEY

Birth of Petronella "Petronilla Of Lampley /De Lee/" Lee [Pimhall] "⁵²⁵ in 1374.

ENGLAND, CHESHIRE

Death of Sir John "John Lee Esquire" de la Lee⁵⁴⁰ in 1301.

ENGLAND, DURHAM, WILLINGTON

Death of Margery Spencheaux Lee [Spencheaux]⁵¹⁵ in 1512.

ENGLAND, GLOUCESTERSHIRE, ALDERTON

Death of Petronilla de la Lee [Corbet]⁵³⁷ in 1319.

ENGLAND, GLOUCESTERSHIRE, ALVESTON

Death of Fulk "Fulko" FitzWarin I, Lord of Whittington and Alderbury, "Guarine de Meer"⁵⁶⁰ in 1170.

ENGLAND, GLOUCESTERSHIRE, THORNBURY

Death of Fulk II "Brunin" Lord of Whittington and Alveston FitzWarin II⁵⁵⁶ on 6 November 1197.

ENGLAND, HAMPSHIRE, BRAMLEY

Death of Warine "The Sherriff" de Metz⁵⁶⁸ in 1115.

ENGLAND, HEMINGBROUGH YORKSHIRE, ST BENET FINK

Birth of Dr. John William Woodall⁴³⁹ on 22 July 1627.

ENGLAND, HEREFORD, YEO

Birth of Katherine Lee [Blount]⁵⁰¹ about 1506.

ENGLAND, HEREFORDSHIRE, KINGSLAND

Birth of Elizabeth Spaight [Powell]⁴⁵² in 1689.

Baptist: Elizabeth Spaight [Powell]⁴⁵² on 30 August 1691.

ENGLAND, LONDON, HART STREET, ST. OLAVE

Burial of Ann Brett [Woode]⁵⁰³.

Death of Ann Brett [Woode]⁵⁰³ in 1568.

ENGLAND, LONDON, ST GILES PARRISH

Birth of Edward Mashborne Mashburn Sr.⁴³³ about 1655.

Birth of Sarah Mashburn [Sindery]⁴³⁴ in 1656.

Birth of Edward Mashborne Mashburn Jr.⁴⁰⁸ on 27 May 1676.

ENGLAND, LONDON, ST. GILES PARRISH

Death of Edward Mashborne Mashburn Sr.⁴³³ on 12 October 1712.

ENGLAND, LONDON, WESTMINSTER

Death of Dr. John William Woodall⁴³⁹ in 1680.

ENGLAND, LONDON

Birth of Surgeon General John Woodall⁴⁵⁷ in 1569.

Death of Surgeon General John Woodall⁴⁵⁷ on 28 August 1643.

Death of Elizabeth Mashburn [Nash]⁴¹⁰ in 1712.

ENGLAND, MIDDLESEX, LONDON

Birth of Ann Lee [Constable]⁴⁶⁰ in 1622.

Birth of Matthew Mashburn⁴²⁰ in 1683.

ENGLAND, SALOP, NORDLEY REGIS

Birth of John Lee Sr.⁴⁷² in 1580.

ENGLAND, SALOP, PIMHILL, LEA HALL, ALDERTON HALL

Birth of Sir Thomas de la Lee⁵³⁶ in 1224.

ENGLAND, SHROPHIRE

Birth of Elizabeth Lee [Bendey]⁴⁸³ in 1567.

ENGLAND, SHROPSHIRE, ACTON BURNELL, LANGLEY

Birth of Sir Thomas Lee⁵⁰⁸ about 1494.

ENGLAND, SHROPSHIRE, ALKINGTON

Birth of Isabella Lee [Ridley]⁵²⁰ in 1425.

ENGLAND, SHROPSHIRE, ALVELEY PARISH

Death of Richard Lee⁴⁸² in 1621.

ENGLAND, SHROPSHIRE, ALVELEY

Death of Elizabeth Lee [Bendey]⁴⁸³ on 12 April 1630.

Burial of Elizabeth Lee [Bendey]⁴⁸³.

ENGLAND, SHROPSHIRE, BRAMLEY

Birth of Fulk "Fulko" FitzWarin I, Lord of Whittington and Alderbury, "Guarine de Meer"⁵⁶⁰ about 1110.

ENGLAND, SHROPSHIRE, BRAMLAY

Death of Sir Guy Warin "the Bold" de Metz⁵⁶⁴ in 1115.

ENGLAND, SHROPSHIRE, COTON NORDLEY REGISTER, ALVELEY

Death of Joyce Lee [Romney]⁴⁹³ on 4 December 1609.

ENGLAND, SHROPSHIRE, DONNINGTON

Birth of Margery Sprencieux Lee [Sprencieux]⁵¹⁵ in 1441.

ENGLAND, SHROPSHIRE, HAUGHTON

Birth of Johanna Lee [Morton]⁵⁰⁹ in 1484.

ENGLAND, SHROPSHIRE, LANGLEY

Death of Robert "Robert /De Lee/" Lee "⁵²⁴ in 1429.

Birth of Sir Richard "Recardus /De Lee/Lee" Lee "⁵¹⁴ in 1432.

Birth of Radolphus "Ralph de Lee" Lee⁵¹⁹ between 1438 and 1447.

Death of Radolphus "Ralph de Lee" Lee⁵¹⁹ on 14 December 1479.

ENGLAND, SHROPSHIRE, LEA HALL

Birth of Reginald "Reginald Reynor de la Lea" de Laga⁵⁴⁴ about 1160.

Birth of Rei Lega de Laga⁵⁴⁵ in 1162.

Birth of Sir John "John Lee Esquire" de la Lee⁵⁴⁰ in 1195.

ENGLAND, SHROPSHIRE, MORETON CORBET

Birth of Petronilla de la Lee [Corbet]⁵³⁷ about 1238.

ENGLAND, SHROPSHIRE, NORDLEY REGIS, ALVELEY PARISH, COTON HALL

Birth of Sir Humphrey "Humphrey De Lee" Lee⁵⁰⁰ about 1505.

ENGLAND, SHROPSHIRE, NORDLEY REGIS, COTON HALL

Birth of Margaret "Margaret de Astley" de Lee [Astley]⁵²⁹ about 1354.

Birth of Sir John "John Lee Esquire" Lee⁴⁹² about 1530.

Birth of Richard Lee⁴⁸² on 10 June 1563.

Birth of Colonel Richard Henry Lee⁴⁵⁹ on 22 March 1618.

ENGLAND, SHROPSHIRE, NORDLEY REGIS, COTON

Birth of Robert "Robert /De Lee/" Lee "⁵²⁴ about 1392.

ENGLAND, SHROPSHIRE, NORDLEY REGIS

Death of Roger "Robert" de Lee⁵²⁸ in 1420.

Death of Margaret "Margaret de Astley" de Lee [Astley]⁵²⁹ in 1423.

Death of Sir Thomas Lee⁵⁰⁸ on 16 March 1526.

Death of Johanna Lee [Morton]⁵⁰⁹ in 1526.

Death of Sir Humphrey "Humphrey De Lee" Lee⁵⁰⁰ on 12 March 1589.

Death of Katherine Lee [Blount]⁵⁰¹ on 20 August 1591.

Burial of Joyce Lee [Romney]⁴⁹³.

ENGLAND, SHROPSHIRE, REGIS NORDLEY

Death of Sir John "John Lee Esquire" Lee⁴⁹² in June 1605.

ENGLAND, SHROPSHIRE, RODEN, STANTON

Birth of Hugo "Hugo de La Lea /de Lee/" de Lega "⁵⁴⁸ in 1140.

ENGLAND, SHROPSHIRE, SALOP

Death of Sir Thomas de la Lee⁵³⁶ in 1258.

ENGLAND, SHROPSHIRE, SHREWSBURY

Death of Rei Lega de Laga⁵⁴⁵ in 1203.
Death of Reginald "Reginald Reynor de la Lea" de Laga⁵⁴⁴ in 1203.

ENGLAND, SHROPSHIRE, STANTON, RODEN

Birth of Roger "Robert" de Lee⁵²⁸ about 1376.

ENGLAND, SHROPSHIRE, WHITTINGTON CASTLE

Birth of Sir Fulk Marcher Lord of Whittington and Alveston FitzWarin III⁵⁵² between 1160 and 1165.

ENGLAND, SHROPSHIRE, WHITTINGTON, WHITTINGTON CASTLE

Birth of Fulk II "Brunin" Lord of Whittington and Alveston FitzWarin II⁵⁵⁶ about 1138.

ENGLAND, SHROPSHIRE, WHITTINGTON

Birth of Miletta de Whittington FitzWarin [de Whittington]⁵⁶¹ in 1116.
Death of Hawise FitzWarin [de Dinan]⁵⁵⁷ in 1226.
Death of Sir Fulk Marcher Lord of Whittington and Alveston FitzWarin III⁵⁵² in 1258.

ENGLAND, SHROPSHIRE

Burial of Sir Humphrey "Humphrey De Lee" Lee⁵⁰⁰.
Burial of Katherine Lee [Blount]⁵⁰¹.

ENGLAND, STAFFORDSHIRE, INGESTRE

Birth of Margaret Britt [Chetwynd]⁴⁸⁵ in 1545.
Marriage of Randle Brett Britt⁴⁸⁴ and Margaret Britt [Chetwynd]⁴⁸⁵ about 1566.
Birth of Thomas Brett Britt⁴⁷⁴ about 1573.

ENGLAND, STAFFORDSHIRE, KEELE

Birth of Ann Brett [Woode]⁵⁰³ about 1487.
Birth of Edward Brett⁴⁹⁴ about 1518.
Marriage of Randolphe Brett⁵⁰² and Ann Brett [Woode]⁵⁰³ about 1518.
Birth of Cissely Brett [Fitton]⁴⁹⁵ about 1522.
Birth of Randle Brett Britt⁴⁸⁴ in 1544.

ENGLAND, STAFFORDSHIRE, KELLE

Birth of Nicolas Brett⁵¹⁶ in 1430.

ENGLAND, STAFFORDSHIRE, MIDDLEHUM

Marriage of Sir John Clois Clowes Clewlowe Clulow⁴⁹⁰ and Lady Isabell Clois Clowes Clewlowe Clulow⁴⁹¹.

ENGLAND, STAFFORDSHIRE, RUDYARD

Birth of Sir John Clois Clowes Clewlowe Clulow⁴⁹⁰ in 1470.
Death of Sir John Clois Clowes Clewlowe Clulow⁴⁹⁰ about 1550.

ENGLAND, STAFFORDSHIRE, WOLSTANTON, DIMMESDALE

Birth of Thomas Brett⁵¹⁰ in 1460.
Birth of Randolphe Brett⁵⁰² in 1492.
Death of Edward Brett⁴⁹⁴ in 1583.

ENGLAND, STAFFORDSHIRE

Burial of Edward Brett⁴⁹⁴.

ENGLAND, SUFFOLK COUNTY, BURY ST. EDMUNDS

Birth of Edmund Brett⁴⁶¹ about 1603.

ENGLAND, SUFFOLK COUNTY, RATTLEDEN

Birth of Susan Brett Britt⁴⁵³ on 24 November 1633.
Birth of John Brett⁴⁴³ on 7 March 1635.
Birth of Elizabeth Brett Britt⁴⁵⁴ on 7 March 1635.
Birth of William Brett⁴⁵⁶ on 8 January 1637.
Marriage of John Brett⁴⁴³ and Ann Brett [Woodward]⁴⁴⁵ in 1661.

ENGLAND, SUFFOLK COUNTY, RATTLESDEN (Continued)

Birth of John Brett⁴²⁵ on 26 February 1669.
Marriage of Edmund Brett⁴⁶¹ and Elizabeth Brett [Lowe]⁴⁶³ on 30 November 1671.
Birth of Nathaniel Brett⁴³⁶ on 23 June 1672.
Birth of Mary Brett⁴³⁷ on 25 March 1677.
Birth of James Brett⁴³⁸ on 5 October 1679.

ENGLAND, SUFFOLK COUNTY

Death of Edmund Brett⁴⁶¹ in 1674.

ENGLAND, SUSSEX COUNTY, KENT

Birth of William Brett Jr.⁴⁵⁵ in 1635.

ENGLAND, SUSSEX, HURSTMONCEUX

Marriage of John Brett⁴⁴³ and Elizabeth Brett [Waters]⁴⁴⁴ in 1678.

ENGLAND, TWING

Birth of Jane Lee [Hancock]⁴⁷³ in 1594.

ENGLAND, WARWICKSHIRE, WARWICK

Death of Richard Woodall⁴⁷⁰ on 20 June 1598.

ENGLAND, WARWICKSHIRE

Birth of Richard Woodall⁴⁷⁰ in 1545.

ENGLAND, WILTSHIRE, SULTON BENDER

Death of Agnes Woodall [Inu/Light] Light⁴⁸¹ on 25 August 1557.

ENGLAND, WORCESTER, LULSLEY

Birth of Joyce Lee [Romney]⁴⁹³ in 1542.

ENGLAND, WORCESTERSHIRE, WORCESTER

Death of John Lee Sr.⁴⁷² on 23 February 1630.

ENGLAND, WORCESTERSHIRE

Birth of Ann Brett [Woodward]⁴⁴⁵ about 1631.

ENGLAND, WORCETERSHIRE, ST. MARTIN'S PARISH

Birth of John Lee II⁴⁶⁸ on 19 September 1616.

ENGLAND

Death of Aimeria Emma de Montgomery de Metz [de Montgomery]⁵⁶⁹ in 1084.
Birth of Rei Mnu de la Lee⁵⁴¹ about 1162.
Death of Hugo "Hugo de La Lea /de Lee/" de Lega "⁵⁴⁸ in 1182.
Death of Rei Mnu de la Lee⁵⁴¹ in 1203.
Death of Petronella "Petronilla Of Lampley /De Lee/" Lee [Pimhall] "⁵²⁵ in 1442.
Death of Isabella Lee [Ridley]⁵²⁰.
Death of Sir Richard "Recardus /De Lee/Lee" Lee Lee"⁵¹⁴ in 1508.
Death of Jane Lee [Hancock]⁴⁷³ in 1638.
Birth of Mary Lee [Young]⁴²⁴ in 1670.
Birth of Richard Henry Lee⁴²³ in 1670.

ERWIN MEMORIAL PARK

Burial of Dewitt Creech Woodall²⁴⁹.
Burial of Leah Elizabeth Woodall [Alley]²⁵⁰.

FRANCE, ALBENY

Death of Baroness Melette Maud ,Heiress of Whittington, "Maud de Ingelrica" de Metz [Peverell]⁵⁶⁵ in 1178.

FRANCE, ALSACE-CHAMPAGNE-ARDENNE-LORRAINE, MOSELLE, METZ

Birth of Warine "The Sherriff" de Metz⁵⁶⁸ in 1050.

FRANCE, AUVERGNE, ALLIER, ROCHEFORT

Birth of Gilles Lord of Rochefort Du Puy I, Knight⁵³⁴ in 1330.

Death of Lord Alleman Du Puy V⁵³⁸ in 1362.

FRANCE, BASSE-NORMANDIE, MANCHE, LA ROCHELLE

Death of Louis DuPre⁴⁸⁶ in 1622.

FRANCE, BASSE-NORMANDIE, MANCHE

Death of Louis Claude DuPre I⁵⁰⁴ in 1572.

Death of Louis Claude DuPre II⁴⁹⁶ in 1612.

FRANCE, BOURGOGNE, NIEVRE (NIÈVRE)

Death of Jaques Henre DuPre II⁵¹⁷ in 1507.

FRANCE, BOURGOGNE, SAONE-ET-LOIRE (SAÔNE-ET-LOIRE)

Death of Margeurite DuPre [Bessonnet]⁴⁷⁷ in 1623.

Death of Jean DuPre⁴⁷⁶ on 7 November 1674.

FRANCE, BOURGOGNE

Birth of Lady Maria DuPre [Esteves]⁵²² in 1435.

Death of Sir Richard DuPre⁵²⁶ in 1471.

Death of Lady Maria DuPre [Esteves]⁵²² in 1475.

FRANCE, BRASSE-NORMANDIE, MANCHE, LA ROCHELLE

Birth of Loys "Louis" Dupree⁴²⁷ in 1683.

FRANCE, BRETAGNE, ILLE ET VILAINE, DINAN

Birth of Hawise FitzWarin [de Dinan]⁵⁵⁷ in 1147.

FRANCE, DROME (DRÔME), PEREINS

Birth of Gillies Lord of Pereins Du Puy II⁵³⁰ in 1366.

FRANCE, GARD, LANGUEDOC-ROUSSILLON

Marriage of Josias "Joseph" Crancie Dupree⁴⁴⁷ and Mynetta "Mary" Denizot Dupree [Lamoreaux]⁴⁴⁸.

FRANCE, HAUTE-SAONE (HAUTE-SAÔNE)

Birth of Josias "Joseph" Crancie Dupree⁴⁴⁷ in 1654.

FRANCE, ILE-DE-FRANCE (ÎLE-DE-FRANCE), PARIS

Birth of Sir Josias DuPre⁵²¹ in 1433.

Birth of Anonette DuPre [Gaillard]⁵¹³ in 1496.

Death of Sir Josias DuPre⁵²¹ in 1507.

Death of Jaques "James" Henre DuPre⁵¹² in 1567.

FRANCE, ILE-DE-FRANCE, PARIS

Birth of Louis Claude DuPre II⁴⁹⁶ in 1533.

Birth of Louis DuPre⁴⁸⁶ in 1561.

FRANCE, ÎLE-DE-FRANCE, YVELINES, SAINT-GERMAIN

Birth of Hugh I de Montgomery⁵⁷⁶ in 980.

FRANCE, ILLE-ET-VILAINE

Birth of Margeurite DuPre [Bessonnet]⁴⁷⁷ in 1590.

Birth of Jean DuPre⁴⁷⁶ on 20 February 1597.

FRANCE, LANGUEDOC-ROUSSILLION, GARD, CANNES

Birth of Mynetta "Mary" Denizot Dupree [Lamoreaux]⁴⁴⁸ in 1656.

FRANCE, LORRAINE

Birth of Christian De Stainton de Lega⁵⁴⁹ about 1142.

FRANCE, LOT-ET-GARONNE

Birth of Barthelemy DuPre⁴⁶⁴ in 1623.

FRANCE, METZ

Birth of Sir Guy Warin "the Bold" de Metz⁵⁶⁴ about 1079.

FRANCE, NORMANDY, CALVADOS, SAINT-GERMAIN-DE-MONTGOMMERY

Birth of Aimeria Emma de Montgomery de Metz [de Montgomery]⁵⁶⁹ about 1035.

FRANCE, NORMANDY

Birth of Joscelina de Montgomery [de Normandie]⁵⁷⁷ between 943 and 1003.

Death of Gilbert de Montgomery⁵⁷² in 1064.

FRANCE, PARIS

Birth of Jaques "James" Henre DuPre⁵¹² in 1490.

Birth of Louis Claude DuPre I⁵⁰⁴ in 1517.

FRANCE, PEREINS

Birth of Hugues Lord of Rochefort Du Puy I⁵⁶² in 1055.

Birth of Ainarde Du Puy [De Roland]⁵³⁹ in 1310.

Birth of Alix Du Puy [de Bellecombe]⁵³⁵ in 1335.

FRANCE, RHÔNE-ALPES (RÉGION), ARDÈCHE, DRÔME, PEREINS

Death of Gilles Lord of Rochefort Du Puy I, Knight⁵³⁴ in 1397.

FRANCE, RHONE-ALPES, DROME, GLANDAGE

Birth of Beatrix Tournon Du Puy [Artod]⁵⁴⁷ in 1210.

FRANCE, RHONE-ALPES, DROME, PEREINS

Birth of Alleman Sgr. of Bordeau Du Puy III⁵⁴⁶ in 1210.

FRANCE, RHONE-ALPES, DRÔME, PEREINS

Birth of Lord Alleman Du Puy V⁵³⁸ in 1290.

FRANCE, RHONE-ALPES, DROME

Birth of Chevalier Alleman Du Puy IV⁵⁴² in 1250.

FRANCE, RHONE-ALPS, (DRÔME), PEREINS

Death of Lady Marie Florence Du Puy [de Hauteville]⁵³¹ in 1477.

FRANCE, RHONE-ALPS, (DRÔME), PEYRINS

Birth of Lady Marie Florence Du Puy [de Hauteville]⁵³¹ in 1378.

FRANCE, UPPER NORMANDY, EURE, CONTEVILLE

Birth of Pétronille de Archaic] Du Puy, Countess of Conteville [de Bérangs⁵⁶⁷ in 994.

FRANCE, VERMANDOIS

Birth of Paschale DuPre [DeVermondois]⁵²⁷ in 1405.

FRANCE

Birth of Joseline de Montgomery [de Vetulis]⁵⁷³ in 1016.

Death of Joseline de Montgomery [de Vetulis]⁵⁷³ in 1100.

Death of Beatrix Tournon Du Puy [Artod]⁵⁴⁷ in 1293.

Death of Alleman Sgr. of Bordeau Du Puy III⁵⁴⁶ on 23 September 1304.

Death of Ainarde Du Puy [De Roland]⁵³⁹ in 1362.

Death of Alix Du Puy [de Bellecombe]⁵³⁵ in 1390.

Birth of Sir Richard DuPre⁵²⁶ in 1400.

Death of Gillies Lord of Pereins Du Puy II⁵³⁰ on 13 May 1420.

FRANCE (Continued)

Birth of Agnes DuPre [Villiers]⁵¹⁸ in 1435.
Death of Paschale DuPre [DeVermondois]⁵²⁷.
Birth of Jaques Henre DuPre II⁵¹⁷ in 1463.
Death of Agnes DuPre [Villiers]⁵¹⁸.
Birth of Alice DuPre [Jospin]⁵⁰⁵ in 1517.
Death of Anonette DuPre [Gaillard]⁵¹³ in 1543.
Birth of Matilda DuPree [Robin]⁴⁶⁵ in 1630.
Death of Matilda DuPree [Robin]⁴⁶⁵ in 1654.
Death of Mynetta "Mary" Denizot Dupree [Lamoreaux]⁴⁴⁸ in September 1690.

GERMANY, BAYERN

Birth of Sevil Civil Franck [Timmerman]⁴⁵⁰ in 1694.

GERMANY, DEUTSCHLAND, SCHLESWIG-HOLSTEIN, LÜBECK

Death of Johannes Francke⁴⁷⁸ in 1663.

GERMANY, DEUTSCHLAND, THÜRINGEN

Birth of Hans Francke Francke⁴⁸⁸ in 1590.

GERMANY, HALLE

Death of August Hermann Francke⁴⁶⁶ on 8 June 1727.

GERMANY, HESSEN-NASSAU, HELDRA

Birth of Catherina Francke [Leimbach]⁴⁹⁹ in 1559.
Birth of Hermann Francke⁴⁹⁸ on 16 March 1566.

GERMANY, LUBECK

Birth of Anna Francke [Gloxin]⁴⁷⁹ on 25 July 1625.
Birth of August Hermann Francke⁴⁶⁶ on 22 March 1663.

GERMANY, PALATINATE SECTION, BAVARIAN, SALSBURG

Birth of John Martin Franck⁴⁴⁹ about 1 June 1675.

GERMANY, SACHSEN, ZWICKAU, LANGENHESEN

Birth of Johannes Francke⁴⁷⁸ on 5 March 1621.

GERMANY, SAXONY-ANHALT, HALLE

Death of Anna Magdalena Francke [von Wurmb]⁴⁶⁷ on 19 March 1734.

GERMANY, THUERINGEN, GOTHA

Death of Anna Francke [Gloxin]⁴⁷⁹ in June 1709.

GERMANY, THURINGIA, KLEINFURRA

Birth of Anna Magdalena Francke [von Wurmb]⁴⁶⁷ on 19 November 1670.

GERMANY, WLDCK., ALFOLDERN

Birth of Hans Francke⁵⁰⁶ in 1534.
Birth of Eva Francke⁵⁰⁷ in 1538.
Death of Hans Francke⁵⁰⁶ on 3 January 1575.
Death of Eva Francke⁵⁰⁷ on 20 May 1579.

HOME

Death of Rachael Jane Dupree [Honeycutt]¹²⁰ on 6 December 2020.

JOHNSTON COUNTY, MOUNT ZION UNITED METHODIST CHURCH

Burial of "Graham" Hubbard Franks²⁴¹.
Burial of Bettie Allene Franks [Barbour]²⁴².

KENTUCKY, GRANT, MT. ZION

Burial of Jacob Miller Franks⁴²⁹.

KENTUCKY

Death of Jacob Miller Franks⁴²⁹ in 1794.

MARYLAND, PRINCE GEORGE COUNTY

Birth of Elizabeth Brett [Lowe]⁴⁶³ about 1628.

MASSACHUSETTS, ESSEX COUNTY, NEWBURY

Death of Hannah Britt⁴¹³.

Birth of John Britt³⁸⁹ on 11 July 1756.

MASSACHUSETTS, ESSEX COUNTY, NEWBURYPORT

Birth of Mary Britt [Moody]⁴⁰⁰ in 1728.

Death of John Britt Jr.³⁹⁸ on 12 December 1797.

Death of John Britt³⁸⁹ on 13 September 1830.

MASSACHUSETTS, NORFOLK COUNTY, DORCHESTER

Birth of Freeloove Britt [Fenno]³⁹⁹ on 1 February 1715.

MASSACHUSETTS, PLYMOUTH COUNTY, BRIDGEWATER

Death of William Brett Jr.⁴⁵⁵ in 1713.

MASSACHUSETTS, SUFFOLK COUNTY, BOSTON

Birth of Elizabeth Brett [Waters]⁴⁴⁴ in 1657.

Birth of Ann Brett [Barnsdale (Barnsdell)]⁴²⁶ on 1 February 1688.

Marriage of John Brett⁴²⁵ and Ann Brett [Barnsdale (Barnsdell)]⁴²⁶ on 29 June 1710.

Birth of Hannah Britt⁴¹³ on 9 May 1711.

Birth of John Britt Jr.³⁹⁸ on 22 July 1713.

Birth of William Brett Britt⁴¹⁴ on 20 January 1719.

MONTANA, YELLOWSTONE CO

Death of Herman Keck Dupree²⁵⁸ in 1991.

NC, ANGIER, GREGORY VINEYARDS

Marriage of Bryant Lee Woodall¹⁷ and Jesse Marie Woodall [Morgan]¹⁸ on 12 October 2019.

NC, AT HOME IN MAGNOLIA

Birth of Betty Jean "BJ" Moore [Wilson]⁶¹⁶ on 15 April 1935.

NC, AT HOME IN RALEIGH

Death of Betty Jean "BJ" Moore [Wilson]⁶¹⁶ on 24 February 2019.

NC, CLAYTON, UNC HEALTH JOHNSON

Birth of Wyatt Lee Woodall² on 16 February 2021.

Birth of Walker Samuel Woodall¹ on 16 February 2021.

NC, DUNN

Death of William Taylor "Billy" Watkins¹⁷⁰ on 13 November 1964.

NC, HARNETT CO, ANGIER, ANGIER PRIMITIVE BAPTIST CHURCH CEMETERY

Burial of Benjamine Franklin Dupree³²⁶.

Burial of Fannie Telfer Dupree [Love]³²⁷.

NC, HARNETT WOODS NURSING HOME DUNN

Death of Virginia Grace Watkins [Matthews]²³⁰ on 12 December 2018.

NC, JOHNSTON CO, MCGEE CROSSROADS, DUPREE FAMILY CEMETERY

Burial of Nathaniel Dupree³⁵⁰.

Burial of Elizabeth Dupree [Turlington]³⁵¹.

NC, KITTY ASKINS HOSPICE CENTER IN GOLDSBORO

Death of William Edward "Billy" Wilson Sr.⁶²² on 6 December 2007.

NC, LANCASTER MEMORIAL PARK MAUSOLEUM LOUISBURG

Burial of Donnie Ray Dupree¹⁴¹.

NC, MOREHEAD CITY, CARTERET HEALTH CARE

Death of Nancy Carol Moore [Washington]⁶¹⁹ on 8 October 2021.

NC, SMITHFIELD, SECU HOSPICE HOUSE

Death of Bill Ulysses Davis¹¹⁴ on 28 February 2018.

NC, WAKE CO, RALEIGH, MONTLAWN MEMORIAL PARK

Burial of William Anguish Dupree Sr.²⁵³.

Burial of Franklin Tell Dupree³⁰².

Death of William Anguish "W.A." Dupree Jr.¹⁸⁷ on 16 January 1999.

Burial of Steve H Fowler⁶⁵⁵.

NORTH CAROLINA, HARNETT COUNTY, LAKESIDE MEMORIAL GARDENS

Burial of Doris Pearl Dupree [Wilkerson]¹³⁸.

NORTH CAROLINA, (WILL FILED) IN BERTIE CO

Death of John Brett⁴²⁵ on 23 May 1738.

NORTH CAROLINA, ANGIER, ANGIER PRIMITIVE BAPTIST CHURCH

Burial of William Taylor "Billy" Watkins¹⁷⁰.

Burial of Timothy Marshburn "Timmy" Watkins¹⁷¹.

Burial of William Marshburn "Bill" Watkins²³⁵.

NORTH CAROLINA, ANGIER, KENNEBEC BAPTIST CHURCH CEMETARY

Burial of Deborah Joanne Moore [Cratch]⁶⁰⁰.

NORTH CAROLINA, ANGIER, NEIL'S CREEK BAPTIST CHURCH

Burial of James Clayborn Butts¹¹².

Burial of Doris Britt Butts [Woodall]¹¹¹.

NORTH CAROLINA, ANGIER, OAK HILL LIVING CENTER

Death of Davis Bryant Woodall¹⁰⁹ on 21 January 2015.

NORTH CAROLINA, ANGIER

Death of Mildred Dupree [Jones]²²⁴ on 11 December 1959.

Death of Emily Adams [Blanchard]¹⁵⁴ on 18 April 2016.

NORTH CAROLINA, APEX, TEN-TEN RD, CATAWBA SPRINGS CHRISTIAN CHURCH CEMETERY

Burial of Emma Gasten Franks [Jones]³⁴¹.

NORTH CAROLINA, BRITTHAVEN IN DUNN

Death of Ruby Larry Dupree [Franks]¹⁹⁹ on 16 September 2004.

NORTH CAROLINA, CARTERET HEALTH CARE MOREHEAD CITY

Death of Charles Allen Moore⁶¹⁸ on 15 March 2017.

NORTH CAROLINA, CARY, FRANKLIN FAMILY CEMETARY

Burial of James Leslie Franks²⁹¹.

Burial of James "Jim" David Franks³⁴⁰.

NORTH CAROLINA, CARY, WAKE MEDICAL CENTER

Birth of Tovi Piper Capps⁵ on 23 September 2009.

NORTH CAROLINA, CHATHAM COUNTY

Birth of John W Perry³⁶⁶ on 15 November 1780.

NORTH CAROLINA, CRAVEN COUNTY

Birth of Jacob Miller Franks⁴²⁹ in 1721.

Death of John Martin Franck⁴⁴⁹ on 3 November 1744.

NORTH CAROLINA, CUMBERLIN COUNTY

Birth of John Adams³⁶⁰ on 19 May 1767.

Death of John Adams³⁶⁰ in 1848.

NORTH CAROLINA, DUNN, BESTY JOHNSON MEMORIAL HOSPITAL

Birth of Kenneth Marvin Watkins⁹⁸ on 10 April 1986.

Birth of Matthew Shane Poole⁹⁹ on 7 April 1987.

Death of Harry Clay Dupree²⁵⁹ on 18 June 2004.

NORTH CAROLINA, DUPLIN COUNTY

Birth of Nancy Britt [Stephens]³⁵⁷ in 1765.

NORTH CAROLINA, EDENTON STREET UNITED METHODIST CHURCH RALEIGH

Marriage of Harry Lee Smith Jr.²⁵ and Jennifer Lynn Smith [Capps]²⁴ on 21 June 2013.

NORTH CAROLINA, EDGECOMB COUNTY

Birth of Lydia Lane [Speight]⁴⁰⁷ on 24 April 1743.

NORTH CAROLINA, FRANKIN COUNTY

Birth of Nancy Ann Perry [Baker]³⁶⁷ in 1784.

NORTH CAROLINA, FRANKLIN COUNTY

Birth of Fred Edward Dean²⁰³ on 19 April 1899.

NORTH CAROLINA, FRANKLIN

Marriage of Edward Woodall Dean¹²⁴ and Annie Duke Dean [Wheless]¹²⁵ on 17 June 1951.

NORTH CAROLINA, FUQUAY VARINA, PLEASANT GROVE BAPTIST CHURCH

Marriage of Roy Neal Moore III⁵⁹⁹ and Deborah Joanne Moore [Cratch]⁶⁰⁰ on 19 August 1989.

NORTH CAROLINA, GAMEWELL, CALDWELL COUNTY, LITTLEJOHN METHODIST CHURCH CEMETERY

Burial of Lance H. Franks²⁹³.

NORTH CAROLINA, GARNER, TEN TEN RD, BRITT FAMILY CEMETARY

Burial of Troy Randolph Britt²⁷⁵.

Burial of Joseph Burke Britt²⁸⁰.

NORTH CAROLINA, GARNER

Death of Issac R Durham⁶³² on 22 September 1911.

Death of Caroline F Durham⁶³³ on 18 November 1926.

NORTH CAROLINA, GOOD HOPE HOSPITAL ERWIN

Death of Clara Emily Dupree [Denning]²²⁸ on 1 April 1980.

Death of Betty Sue Woodall [Dupree]¹¹⁰ on 22 December 2001.

NORTH CAROLINA, HALIFAX COUNTY

Birth of James Lane⁴⁰⁶ in 1739.

Marriage of James Lane⁴⁰⁶ and Lydia Lane [Speight]⁴⁰⁷ in 1760.

NORTH CAROLINA, HARNETT COUNTY, LAKESIDE MEMORIAL GARDENS

Burial of Barry Sherman Dupree⁹⁵.

Burial of John Elmond Dupree Sr.²⁵¹.

Burial of Ottis Alden Dupree²¹⁷.

Burial of CPL Kenneth Lee Watkins²²⁹.

NORTH CAROLINA, HARNETT COUNTY, LAKESIDE MEMORIAL GARDENS (Continued)

Burial of John Stuart Dupree¹⁹⁸.
 Burial of Carolyn Watkins [Johnson]²³³.
 Burial of Shirley Faye Watkins [Wilkerson]²³¹.
 Burial of Betty Sue Woodall [Dupree]¹¹⁰.
 Burial of Patsy Ennis O'Neal [Dupree]¹⁴⁹.
 Burial of Ruby Larry Dupree [Franks]¹⁹⁹.
 Burial of Brandon Lee Price⁴⁴.
 Burial of Daniel Parker "Danny" Watkins²³².
 Burial of John Royster Dupree¹¹⁷.
 Burial of Davis Bryant Woodall¹⁰⁹.
 Burial of Susan "Elaine" Price [Dupree]⁸⁷.

NORTH CAROLINA, HARNETT COUNTY, RAWLS CHURCH BAPTIST CHURCH CEMETARY

Burial of Rex Kenneth Bradley²¹¹.
 Burial of Sallie Muriel Bradley [Woodall]²¹⁰.

NORTH CAROLINA, HARNETT COUNTY, YOUNG FAMILY CEMETERY ON COUNTY LINE RD

Burial of Charlie Benton Dupree²⁶⁵.
 Burial of William Adderson Watkins²⁶⁹.
 Burial of Martha Caroline Dupree [Young]²⁶⁶.
 Burial of Vienna Jannetta Franks [Marshburn]²⁶⁸.
 Burial of Stuart Randall "Randy" Dupree¹²¹.

NORTH CAROLINA, HARNETT COUNTY

Birth of Eira Watkins [Taylor]²³⁶ on 21 March 1924.
 Birth of Frank Alley "Al" Woodall¹⁸³ on 7 December 1945.
 Death of Ottis Alden Dupree²¹⁷ on 4 August 1971.

NORTH CAROLINA, JOHNSTON COUNTY, BETHEL PRIMITIVE BAPTIST CHURCH CEMETERY

Burial of Silas Greene Adams²²².
 Burial of Charles Glenn Dupree²²⁷.
 Burial of Ila Ann Adams [Dupree]²²¹.
 Burial of Daley Glenn Dupree¹⁵⁸.
 Burial of Clara Emily Dupree [Denning]²²⁸.
 Burial of Joseph Gerald "Butch" Adams¹⁵⁵.

NORTH CAROLINA, JOHNSTON COUNTY, MOUNT ZION UNITED METHODIST CHURCH

Burial of Leddie Bain Franks²⁸⁴.
 Burial of Lillian "Lillie" Mary Franks [Godwin]²⁸⁵.

NORTH CAROLINA, JOHNSTON COUNTY, SR 1531 PLEASANT GROVE TOWNSHIP, FAMILY CEMETERY

Burial of Julia Ann Dupree [Adams]³¹¹.
 Burial of James G Dupree³¹⁰.

NORTH CAROLINA, JOHNSTON COUNTY, W. A. DUPREE FAMILY CEMETERY

Burial of William "Anguish" Dupree²⁹⁸.
 Burial of Lugenia Elizabeth "Bettie" Dupree [Smith]²⁹⁹.

NORTH CAROLINA, JOHNSTON COUNTY

Birth of Abigail Spaight [Westropp]⁴³² in 1724.
 Birth of Ann Lee [Rains]³⁵⁵ in 1755.
 Birth of Jacob B. Woodall³⁵² in 1767.
 Birth of Henry "Harry" Lee³³⁰ in 1781.
 Death of Jacob Woodall³⁷¹ in 1808.
 Birth of Ransom Lee³⁰⁶ on 29 August 1820.
 Death of Ann Lee [Rains]³⁵⁵ in 1821.
 Birth of Burt A Woodall³⁰⁴ in 1829.
 Birth of Eliza Woodall [Wellons]³⁰⁵ in 1830.
 Death of Lemuel Samuel "Lom" Lee³⁵⁴ on 15 September 1843.
 Death of Jacob B. Woodall³⁵² in 1849.

NORTH CAROLINA, JOHNSTON COUNTY (Continued)

Death of Lucy Phereby Woodall [Gower]³⁵³ in 1851.
 Birth of Edward Hale Woodall²⁶¹ on 26 May 1861.
 Death of James Gower Woodall³²⁸ in 1865.
 Birth of Sarah Woodall [Lee]²⁶² on 13 December 1871.
 Death of Ransom Lee³⁰⁶ in July 1882.
 Birth of Gilbert Chesley Woodall¹⁹⁶ on 29 November 1893.
 Birth of Hunter McGuire Woodall²⁰⁰ on 3 March 1896.
 Birth of Bettie Vandon Dean [Woodall]²⁰² on 2 April 1898.
 Birth of Clida Lee Woodall²⁰⁴ on 28 September 1901.
 Birth of Leigh Edward Woodall²⁰⁵ on 2 July 1903.
 Birth of Bert Albert Woodall²⁰⁷ on 31 August 1906.
 Birth of Willis Lester Woodall²⁰⁹ on 7 March 1910.
 Birth of Sallie Muriel Bradley [Woodall]²¹⁰ on 17 June 1913.
 Birth of Bill Ulysses Davis¹¹⁴ on 28 June 1922.

NORTH CAROLINA, JONES COUNTY

Death of Sevil Civil Franck [Timmerman]⁴⁵⁰ in 1752.

NORTH CAROLINA, LAFAYETTE MEMORIAL PARK FAYETTEVILLE

Burial of Rex Kenneth Bradley Jr.¹³³.

NORTH CAROLINA, LEE COUNTY

Birth of Fannie Lee Woodall [Goldston]²⁰¹ on 28 January 1898.

NORTH CAROLINA, LENOIR, CALDWELL COUNTY

Death of Lance H. Franks²⁹³ on 5 July 1972.

NORTH CAROLINA, LILLINGTON, E. CARLTON POWELL HOSPICE CENTER

Death of Doris Britt Butts [Woodall]¹¹¹ on 17 March 2009.

NORTH CAROLINA, LILLINGTON, HARNETT MEMORIAL PARK

Burial of Alda Leland Woodall [Britt]¹⁹⁷.
 Burial of Edward Hale Woodall²⁶¹.
 Burial of Clida Lee Woodall²⁰⁴.
 Burial of Broughton C Britt²¹⁵.
 Burial of Billie Jean Dupree [Stephenson]¹¹⁶.
 Burial of Charles Larry Dupree¹¹⁵.
 Burial of Gilbert Chesley Woodall¹⁹⁶.
 Burial of Ila Britt²¹³.
 Burial of Rado Utah Ennis [Britt]²¹⁴.
 Burial of Bert Albert Woodall²⁰⁷.
 Burial of Larry Gene Dupree⁶².
 Burial of Annie Sexton [Britt]²¹².
 Burial of Candice Mozelle Woodall [Fish]²⁰⁸.
 Burial of Raythell Greene Adams¹⁵³.
 Burial of Emily Adams [Blanchard]¹⁵⁴.
 Burial of Joseph Ronald "Ronnie" Adams⁹⁷.

NORTH CAROLINA, LITTLETON

Birth of Lora Ann Moore [Gray]⁶¹⁷ on 19 May 1939.

NORTH CAROLINA, MARIETTA, ROBESON COUNTY

Death of Emma Foy Hayes [Franks]²⁸⁶ on 19 April 1929.

NORTH CAROLINA, MARKET HALL RALEIGH

Marriage of Cody Davis Woodall¹⁹ and Christine Denise Woodall [Wilder]²⁰ on 15 May 2016.

NORTH CAROLINA, NORTHAMPTON COUNTY

Birth of Sarah Mashburn³⁸⁷ in 1703.
 Death of Sarah Mashburn³⁸⁷.

NORTH CAROLINA, NORTHAMPTON COUNTY (Continued)

Death of Matthew Mashburn³⁸⁶ on 1 July 1760.
Birth of Delphia Mashburn [Warren]³⁶⁹ about 1773.

NORTH CAROLINA, ONSLOW COUNTY

Death of Edward Mashborne Mashburn Jr.⁴⁰⁸ on 22 April 1739.

NORTH CAROLINA, PITT COUNTY

Birth of Haley Dupree⁴⁰² in 1727.

NORTH CAROLINA, PROBABLY CUMBERLIN COUNTY

Death of Delphia Mashburn [Warren]³⁶⁹ after 1861.

NORTH CAROLINA, PROVINCE OF

Birth of Mary Ann Franks [Ashley]⁴³⁰ in 1725.
Birth of Martha Franks [Cook]⁴⁰⁵ in 1749.

NORTH CAROLINA, RALEIGH, CITY CEMETARY

Burial of Samuel "Lattie" Franks²⁸².

NORTH CAROLINA, RALEIGH, ERNEST MYATT PRESBYTERIAN CHURCH

Marriage of Roy Neal Moore Jr.⁶¹⁵ and Betty Jean "BJ" Moore [Wilson]⁶¹⁶ on 6 June 1958.
Marriage of Davis Bryant "Dave" Woodall Jr.⁵¹ and Karen Denise Woodall [Moore]⁵² on 12 December 1987.

NORTH CAROLINA, RALEIGH, MONTLAWN MEMORIAL PARK

Burial of Mamie Ethel Moore [Durham]⁶²⁶.
Burial of Cary Melvin Dupree²²³.
Burial of William Nathan "Mutt" Carroll¹⁷⁴.
Burial of Graham Dennis Shepard²⁴⁶.
Burial of Roy Neal Moore⁶²⁵.
Burial of Alpha Byon Franks²⁹⁵.
Burial of Betty "Josephine" Carroll [Franks]¹⁷³.
Burial of Annie Lee Shepard [Franks]²⁴⁵.

NORTH CAROLINA, RALEIGH, OAKWOOD CEMENTARY

Burial of Lora Ann Moore [Gray]⁶¹⁷.

NORTH CAROLINA, RALEIGH, OAKWOOD CEMETARY

Burial of Julia A. Perry [Speight]³⁴³.
Burial of Jane Ellen Perry [Watkins]³⁴⁵.
Burial of Robert Sidney Perry³⁴².

NORTH CAROLINA, RALEIGH, RALEIGH COMMUNITY (NOW DUKE)

Birth of Chase Hunter Woodall²¹ on 11 February 1997.

NORTH CAROLINA, RALEIGH, REX HOSPITAL

Birth of Davis Bryant "Dave" Woodall Jr.⁵¹ on 12 July 1953.
Birth of Karen Denise Woodall [Moore]⁵² on 10 June 1963.

NORTH CAROLINA, RALEIGH, TEN-TEN RD, HOLLAND'S UMC

Burial of Ruby Mable Beck [Franks]²⁸⁸.
Burial of Lewis Nathaniel "Snooks" Franks²⁸⁹.
Burial of Luther Warren Franks²⁴³.
Burial of Lydia Franks [Massey]²⁹⁰.

NORTH CAROLINA, RALEIGH, UNC REX HOSPITAL

Birth of Peyton James Woodall³ on 14 November 2020.
Birth of Carter Davis Woodall⁴ on 11 December 2021.

NORTH CAROLINA, RALEIGH, WAKE MEDICAL CENTER

Birth of Bryant Lee Woodall¹⁷ on 4 May 1990.
Birth of Cody Davis Woodall¹⁹ on 6 August 1992.

NORTH CAROLINA, RALEIGH, WENTWORTH BIBLE CHURCH CEMETARY

Burial of Robert Larry Franks²⁶⁷.
Burial of Grover Carr Franks²⁸⁷.
Burial of Lee Perry Franks²⁹².
Burial of Christopher Clinton Franks²⁹⁴.

NORTH CAROLINA, RALEIGH

Death of Neal Henry Moore⁶³⁰.
Birth of Charles Allen Moore⁶¹⁸ on 9 July 1936.
Death of Lee Perry Franks²⁹² on 31 August 1968.
Death of John Stuart Dupree¹⁹⁸ on 23 July 1976.
Death of Christopher Clinton Franks²⁹⁴ on 19 August 1984.

NORTH CAROLINA, RIVERSIDE CEMETERY SMITHFIELD

Burial of Burt A Woodall³⁰⁴.

NORTH CAROLINA, ROCKY MOUNT

Birth of Neal Henry Moore⁶³⁰ in 1872.

NORTH CAROLINA, SELMA, JOHNSTON COUNTY

Burial of Susan Alice Marshburn [Parker]³¹⁶.
Burial of Dr Berry Daniel Marshburn³¹⁵.

NORTH CAROLINA, VETERANS HOSPITAL FAYETTEVILLE

Death of Gilbert Chesley Woodall¹⁹⁶ on 24 December 1978.

NORTH CAROLINA, WAKE COUNTY, HOUSES CREEK

Birth of William Emory⁶⁴⁰ on 23 March 1844.

NORTH CAROLINA, WAKE COUNTY, MCCULLERS, FRANKS FAMILY CEMETARY

Burial of Lorenda Arinda "Lora" Franks [Perry]³¹³.
Burial of William Nathaniel "Nat" Franks³¹².

NORTH CAROLINA, WAKE COUNTY, MCCULLERS

Birth of Samuel "Lattie" Franks²⁸² on 3 March 1884.
Birth of Robert Larry Franks²⁶⁷ on 28 February 1886.
Birth of Emma Foy Hayes [Franks]²⁸⁶ on 9 June 1889.
Birth of James Leslie Franks²⁹¹ on 28 April 1897.
Birth of Lee Perry Franks²⁹² on 14 January 1898.
Birth of Lance H. Franks²⁹³ on 26 July 1900.
Death of James Leslie Franks²⁹¹ in 1901.
Birth of Christopher Clinton Franks²⁹⁴ on 15 July 1905.
Birth of Alpha Byon Franks²⁹⁵ on 14 February 1909.
Death of Lorenda Arinda "Lora" Franks [Perry]³¹³ on 1 June 1912.

NORTH CAROLINA, WAKE COUNTY

Birth of Nathaniel M. Lane³⁸⁴ on 11 November 1770.
Birth of Joseph Britt Jr.³⁵⁶ in 1774.
Birth of Lewis Henry Franks³⁸⁰ in 1777.
Birth of Elizabeth Lane [Smith]³⁸⁵ on 31 January 1779.
Birth of Sarah Franks [Freeman]³⁸¹ in 1780.
Marriage of Joseph Britt³⁷⁵ and Olive Britt [Davis]³⁷⁷ on 26 January 1788.
Death of Haley Dupree II³⁷⁸.
Marriage of Joseph Britt Jr.³⁵⁶ and Nancy Britt [Stephens]³⁵⁷ on 16 November 1790.
Birth of Hardy Britt³³² in 1800.
Birth of Charlotte Britt [Penny]³³³ in 1800.
Death of James Lane⁴⁰⁶ on 6 January 1805.

NORTH CAROLINA, WAKE COUNTY (Continued)

Death of Lydia Lane [Speight]⁴⁰⁷ in 1805.
 Birth of Ephraim Emery⁶⁴⁶ in 1807.
 Marriage of Lewis Henry Franks³⁸⁰ and Sarah Franks [Freeman]³⁸¹.
 Death of Anthony Franks⁴⁰⁴ in 1820.
 Marriage of Hardy Britt³³² and Charlotte Britt [Penny]³³³ on 21 January 1823.
 Death of Martha Franks [Cook]⁴⁰⁵ in 1827.
 Birth of Robert Sidney Perry³⁴² on 27 August 1829.
 Birth of Julia A. Perry [Speight]³⁴³ on 15 July 1831.
 Birth of Joseph Leonard Britt³⁰⁸ on 27 May 1837.
 Birth of Jane Ellen Perry [Watkins]³⁴⁵ on 17 July 1842.
 Death of Pvt Daniel Mashburn³⁶⁸ on 31 January 1848.
 Death of Nancy Ann Perry [Baker]³⁶⁷ in 1850.
 Death of Lewis Henry Franks³⁸⁰ in 1850.
 Death of Nathaniel M. Lane³⁸⁴ on 5 July 1852.
 Birth of William Nathaniel "Nat" Franks³¹² on 25 December 1858.
 Birth of Lorenda Arinda "Lora" Franks [Perry]³¹³ on 12 August 1864.
 Death of Julia A. Perry [Speight]³⁴³ on 11 July 1868.
 Death of Anthony Franks³⁶² in 1871.
 Death of Hardy Britt³³² in 1878.
 Birth of Grover Carr Franks²⁸⁷ on 13 March 1892.
 Birth of Madeline Clyde Woodall [Hocutt]²⁰⁶ on 2 May 1898.
 Death of Jane Ellen Perry [Watkins]³⁴⁵ on 15 September 1912.
 Birth of Ruby Larry Dupree [Franks]¹⁹⁹ on 20 April 1913.
 Death of Robert Sidney Perry³⁴² on 14 September 1913.
 Death of Samuel "Lattie" Franks²⁸² on 18 December 1958.
 Death of Grover Carr Franks²⁸⁷ on 3 February 1963.
 Death of Alpha Byon Franks²⁹⁵ on 6 October 1993.
 Burial of Frankie Wayne "Red Bug" Carroll¹⁰⁰.

NORTH CAROLINA, WENDELL, WAKE COUNTY

Death of Robert Larry Franks²⁶⁷ on 29 July 1913.

NORTH CAROLINA

Birth of Elizabeth Mashburn [Rhodes]⁴⁰⁹ in 1675.
 Birth of Lemuel Samuel "Lom" Lee³⁵⁴ on 5 March 1753.
 Death of Capt. John Esquire Lee³⁹⁶ on 4 December 1766.
 Birth of Lucy Phereby Woodall [Gower]³⁵³ in 1770.
 Death of Agnes Woodall [Hicks]³⁷² in 1773.
 Death of Edward G Lee³⁷³ in 1775.
 Birth of Sarah "Sally" Woodall [Barber]³²⁹ in 1802.
 Birth of Margaret Emery⁶⁴⁷ in 1817.
 Birth of Susan Alice Marshburn [Parker]³¹⁶ on 3 November 1852.
 Birth of Alda Leland Woodall [Britt]¹⁹⁷ on 18 April 1898.

PENNSYLVANIA, BUCKS COUNTY, WASHINGTON CROSSING NATIONAL CEMENTARY NEWTOWN

Burial of Charles R "Chuck" Pumroy⁶²¹.

PLAINVIEW

Burial of Rachael Jane Dupree [Honeycutt]¹²⁰.

POLAND

Marriage of Sir Richard DuPre⁵²⁶ and Paschale DuPre [DeVermondois]⁵²⁷.

ROSE HILL CEMETERY

Burial of Joan Wilson [Brown]⁶²³.
 Burial of William Edward "Billy" Wilson Sr.⁶²².

ROY NEAL MOORE III HOME IN WAKE COUNTY NC

Death of Roy Neal Moore Jr.⁶¹⁵ on 11 March 2023.

SOUTH CAROLINA, ANDERSON

Marriage of John Woodall⁴²¹ and Sarah Woodall [Stanley]⁴²².

SOUTH CAROLINA, MARION COUNTY, MARION

Death of Daniel Britt³⁹¹ in 1840.

SOUTH CAROLINA, MOUNT PLEASANT

Marriage of Cade Wallace Honeycutt³⁸ and Hannah Elizabeth Honeycutt [Overby]³⁹ on 28 October 2022.

SOUTH CAROLINA, SUMMERTON

Death of John Royster Dupree¹¹⁷ on 16 November 2013.

SPAIN

Birth of Elizabeth DuPre [Gonzales]⁴⁸⁷ in 1570.

Death of Elizabeth DuPre [Gonzales]⁴⁸⁷ in 1630.

VIRGINIA OR MASSACHUSETTS

Birth of Olive Britt [Davis]³⁷⁷ about 1735.

VIRGINIA OR NORTH CAROLINA

Birth of Ms. Britt³⁷⁶ about 1740.

VIRGINIA, BRUNSWICK

Death of Larance Lara Dupree [Ellerbee]⁴²⁸ in 1734.

Death of Loys "Louis" Dupree⁴²⁷ on 12 July 1748.

VIRGINIA, FRANKLIN

Death of John Issac Woodall³⁹⁴ in 1809.

VIRGINIA, GOOCHLAND COUNTY, GOOCHLAND

Death of Sarah Woodall [Stanley]⁴²² in 1747.

Birth of Agnes Woodall [Hicks]³⁷² in 1750.

VIRGINIA, GOOCHLAND COUNTY

Marriage of John Issac Woodall³⁹⁴ and Judith Woodall [Sampson]³⁹⁵ in 1731.

Birth of Jacob Woodall³⁷¹ in 1740.

Marriage of John Britt Jr.³⁹⁸ and Winifred Britt [Connolly]⁴⁰¹ on 9 October 1756.

Birth of James Britt³⁹⁰ on 9 July 1758.

Birth of Daniel Britt³⁹¹ on 28 September 1760.

Birth of Milly Britt³⁹² on 19 July 1763.

Birth of Molly Britt³⁹³ on 10 January 1766.

Death of Winifred Britt [Connolly]⁴⁰¹ in 1770.

Death of William Brett Britt⁴¹⁴ on 4 January 1787.

Death of James Britt³⁹⁰.

VIRGINIA, GOOCHLAND

Birth of John Issac Woodall³⁹⁴ in 1710.

Death of John Woodall⁴²¹ on 19 March 1750.

VIRGINIA, GREENVILLE

Marriage of Haley Dupree⁴⁰² and Susannah Elizabeth Dupree [Garris]⁴⁰³.

VIRGINIA, HALIFAX

Death of Captain William Spaight⁴³¹ in May 1774.

VIRGINIA, HENRICO COUNTY

Birth of John Woodall⁴²¹ in 1678.

VIRGINIA, ISLE OF WIGHT COUNTY

Birth of Susannah Brett [Bressie]⁴⁴⁶ about 1680.

Marriage of John Brett⁴⁴³ and Susannah Brett [Bressie]⁴⁴⁶ in 1699.

VIRGINIA, ISLE OF WIGHT COUNTY (Continued)

Death of John Brett⁴⁴³ about 1718.

Death of Joseph Britt³⁷⁵ in 1799.

VIRGINIA, ISLE OF WRIGHT

Death of Elizabeth Spaight [Powell]⁴⁵² in 1739.

VIRGINIA, KING QUEEN (KING AND QUEEN)

Death of Richard Henry Lee⁴²³ in 1726.

VIRGINIA, KING QUEEN, SUIT

Death of William Lee⁴⁴¹ on 25 May 1709.

VIRGINIA, LUNENBERG

Birth of Larance Lara Dupree [Ellerbee]⁴²⁸ in 1686.

Marriage of Loys "Louis" Dupree⁴²⁷ and Larance Lara Dupree [Ellerbee]⁴²⁸.

VIRGINIA, NANESMOND, ISLE OF WRIGHT

Birth of Captain William Spaight⁴³¹ in 1714.

VIRGINIA, NANSEMOND COUNTY

Death of William Brett⁴⁵⁶ in 1711.

VIRGINIA, NANSEMOND

Birth of Matthew Mashburn³⁸⁶ in 1703.

VIRGINIA, NEAR SOUTH QUAY, ISLE OF WRIGHT COUNTY

Birth of John Thomas Speight⁴⁵¹ in 1687.

VIRGINIA, NEW KENT

Birth of Capt. John Esquire Lee³⁹⁶ in 1689.

VIRGINIA, NORTHCUMBERLAND

Birth of William Lee⁴⁴¹ in 1651.

VIRGINIA, NORTHUMBERLAND, DIVIDING CREEK

Death of Colonel Richard Henry Lee⁴⁵⁹ on 1 March 1664.

VIRGINIA, NORTHUMBERLAND

Death of Ann Lee [Constable]⁴⁶⁰ on 6 October 1706.

VIRGINIA, PRINCE WILLIAM COUNTY

Birth of Winifred Britt [Connolly]⁴⁰¹ about 1735.

VIRGINIA, SOUTHAMPTON COUNTY, GREENSVILLE

Birth of Henry Dupree³⁵⁸ in 1784.

VIRGINIA, SOUTHAMPTON COUNTY

Death of Joseph Britt Jr.³⁵⁶ in 1839.

VIRGINIA, SUFFOLK COUNTY

Death of John Thomas Speight⁴⁵¹ in 1738.

VIRGINIA

Birth of Sherry Lynne Watkins [Taylor]¹⁶⁰.

Birth of Alice Lee [Felton]⁴⁴² in 1655.

Birth of Sarah Woodall [Stanley]⁴²² in 1680.

Death of Mary Lee [Young]⁴²⁴.

Death of Barthelemy DuPre⁴⁶⁴ in 1701.

Death of Alice Lee [Felton]⁴⁴² in 1703.

Birth of Edward G Lee³⁷³ in 1725.

VIRGINIA (Continued)

Birth of Mary Lee [Allen]³⁷⁴ in 1726.

Birth of Kizzie Dupree [Young]³⁵⁹ about 1777.

Death of Mary Ann Franks [Ashley]⁴³⁰ in 1789.

17. INDEX OF DATES

- 5 A.D**
Birth of Sharon Rogers [Pumroy]⁶⁰⁴ in January.
- 870**
Birth of Roger I de Montgomery⁵⁸⁷.
- 900**
Birth of Roger II de Montgomery⁵⁸⁵.
- 915**
Birth of Berchta de podio del puech [d'Opfikon]⁵⁷⁵ between 915 and 975.
Birth of Guillaume de podio del puech⁵⁷⁴ between 915 and 975.
- 920**
Birth of Elizabeth de Montgomery [de Tripon]⁵⁸¹ between 920 and 980.
- 930**
Birth of Roger III de Montgomery⁵⁸³.
- 941**
Birth of Amelie de podio [de Heitz]⁵⁷¹ between 941 and 995.
- 943**
Birth of Joscelina de Montgomery [de Normandie]⁵⁷⁷ between 943 and 1003, in Normandy, France.
- 955**
Birth of William de Montgomery⁵⁸⁰.
- 975**
Birth of Jeanne de podio del puech [d'Archingaux]⁵⁷⁹ before 975.
Birth of Norman Anglo saxony (de Pugio) de podio del puech⁵⁸² before 975.
Birth of Amelius Simplious (de Pugio) de podio del puech⁵⁷⁸ before 975.
Birth of Gaius Suetonius Paulinus de Pugio⁵⁸⁶ before 975.
Birth of Adminius Amminius de podio del puech⁵⁸⁴ before 975.
- 980**
Birth of Hugh I de Montgomery⁵⁷⁶ in Saint-Germain, Yvelines, Île-de-France, France.
Birth of Raymond Guillaume de podio⁵⁷⁰.
- 985**
Birth of Gilbert de Montgomery⁵⁷² between 985 and 1035.
- 994**
Birth of Pétronille de Archaic] Du Puy, Countess of Conteville [de Bérengs⁵⁶⁷ in Conteville, Eure, Upper Normandy, France.
- 1011**
Birth of Grand Chamberlain Conrad II Raphael (del Poggio) Du Puy⁵⁶⁶.
- 1016**
Birth of Joseline de Montgomery [de Vetulis]⁵⁷³ in France.
- 1035**
Birth of Aimeria Emma de Montgomery de Metz [de Montgomery]⁵⁶⁹ in about 1035, in Saint-Germain-de-Montgommery, Calvados, Normandy, France.
- 1048**
Death of Pétronille de Archaic] Du Puy, Countess of Conteville [de Bérengs⁵⁶⁷.
- 1050**
Death of Raymond Guillaume de podio⁵⁷⁰.
Birth of Warine "The Sherriff" de Metz⁵⁶⁸ in Metz, Moselle, Alsace-Champagne-Ardenne-Lorraine, France.
- 1055**
Birth of Hugues Lord of Rochefort Du Puy I⁵⁶² in Pereins, France.
- 1062**
Death of Grand Chamberlain Conrad II Raphael (del Poggio) Du Puy⁵⁶⁶.
- 1064**
Death of Gilbert de Montgomery⁵⁷² in Normandy, France.
- 1075**
Birth of Baroness Melette Maud ,Heiress of Whittington, "Maud de Ingelrica" de Metz [Peverell]⁵⁶⁵ in Brunne, Cambridgeshire, England.
Marriage of Hugues Lord of Rochefort Du Puy I⁵⁶² and Deurard DE POISIEU Du Puy⁵⁶³.
- 1077**
Birth of Chevalier Alleman Du Puy I⁵⁵⁸.
- 1079**
Birth of Sir Guy Warin "the Bold" de Metz⁵⁶⁴ in about 1079, in Metz, France.
- 1084**
Death of Aimeria Emma de Montgomery de Metz [de Montgomery]⁵⁶⁹ in England.

- 1100**
Death of Joseline de Montgomery [de Vetulis]⁵⁷³ in France.
- 1102**
Birth of Eva FitzWarin [de Blancminister Warrine]⁵⁵³ between 1102 and 1140.
- 1110**
Death of Hugues Lord of Rochefort Du Puy I⁵⁶².
Birth of Fulk "Fulko" FitzWarin I, Lord of Whittington and Alderbury, "Guarine de Meer"⁵⁶⁰ in about 1110, in Bramley, Shropshire, England.
- 1115**
Death of Sir Guy Warin "the Bold" de Metz⁵⁶⁴ in Bramly, Shropshire, England.
Death of Warine "The Sherriff" de Metz⁵⁶⁸ in Bramley, Hampshire, England.
- 1116**
Birth of Miletta de Whittington FitzWarin [de Whittington]⁵⁶¹ in Whittington, Shropshire, England.
- 1125**
Marriage of Chevalier Alleman Du Puy I⁵⁵⁸ and Lady Veronique Ademar Du Puy⁵⁵⁹.
- 1130**
Birth of Chevalier Hugues Apifer & Montbrun Du Puy II , Seigneur de Pereins, Rochefort⁵⁵⁴.
- 1138**
Birth of Fulk II "Brunin" Lord of Whittington and Alveston FitzWarin II⁵⁵⁶ in about 1138, in Whittington Castle, Whittington, Shropshire, England.
- 1140**
Birth of Hugo "Hugo de La Lea /de Lee/" de Lega "⁵⁴⁸ in Stanton, Roden, Shropshire, England.
- 1142**
Birth of Christian De Stainton de Lega⁵⁴⁹ in about 1142, in Lorraine, France.
- 1147**
Birth of Hawise FitzWarin [de Dinan]⁵⁵⁷ in Dinan, Ille Et Vilaine, Bretagne, France.
- 1150**
Death of Chevalier Alleman Du Puy I⁵⁵⁸.
- 1160**
Birth of Reginald "Reginald Reynor de la Lea" de Laga⁵⁴⁴ in about 1160, in Lea Hall, Shropshire, England.
Birth of Sir Fulk Marcher Lord of Whittington and Alveston FitzWarin III⁵⁵² between 1160 and 1165, in Whittington Castle, Shropshire, England.
- 1162**
Birth of Rei Lega de Laga⁵⁴⁵ in Lea Hall, Shropshire, England.
Birth of Rei Mnu de la Lee⁵⁴¹ in about 1162, in England.
- 1165**
Marriage of Chevalier Hugues Apifer & Montbrun Du Puy II , Seigneur de Pereins, Rochefort⁵⁵⁴ and Floride Du Puy [De Morian]⁵⁵⁵.
- 1170**
Birth of Chevalier Alleman de Montbrun Seigneur de Pereins Du Puy II⁵⁵⁰.
Death of Fulk "Fulko" FitzWarin I, Lord of Whittington and Alderbury, "Guarine de Meer"⁵⁶⁰ in Alveston, Gloucestershire, England.
- 1178**
Death of Baroness Melette Maud ,Heiress of Whittington, "Maud de Ingelrica" de Metz [Peverell]⁵⁶⁵ in Albeny, France.
- 1180**
Death of Chevalier Hugues Apifer & Montbrun Du Puy II , Seigneur de Pereins, Rochefort⁵⁵⁴.
Birth of Alix Princess of Dauphine Du Puy⁵⁵¹.
- 1182**
Death of Hugo "Hugo de La Lea /de Lee/" de Lega "⁵⁴⁸ in England.
- 1195**
Birth of Sir John "John Lee Esquire" de la Lee⁵⁴⁰ in Lea Hall, Shropshire, England.
- 1197**
Death of Fulk II "Brunin" Lord of Whittington and Alveston FitzWarin II⁵⁵⁶ on 6 November, in Thornbury, Gloucestershire, England.
- 1203**
Death of Reginald "Reginald Reynor de la Lea" de Laga⁵⁴⁴ in Shrewsbury, Shropshire, England.
Death of Rei Lega de Laga⁵⁴⁵ in Shrewsbury, Shropshire, England.
Death of Rei Mnu de la Lee⁵⁴¹ in England.
Death of Christian De Stainton de Lega⁵⁴⁹.

- 1205** Marriage of Chevalier Alleman de Montbrun Seigneur de Pereins Du Puy II⁵⁵⁰ and Alix Princess of Dauphine Du Puy⁵⁵¹.
- 1210** Birth of Alleman Sgr. of Bordeaux Du Puy III⁵⁴⁶ in Pereins, Drome, Rhone-Alpes, France.
Birth of Beatrix Tournon Du Puy [Artod]⁵⁴⁷ in Glandage, Drome, Rhone-Alpes, France.
- 1224** Birth of Sir Thomas de la Lee⁵³⁶ in Alderton Hall, Lea Hall, Pimhill, Salop, England.
- 1226** Death of Hawise FitzWarin [de Dinan]⁵⁵⁷ in Whittington, Shropshire, England.
- 1229** Death of Chevalier Alleman de Montbrun Seigneur de Pereins Du Puy II⁵⁵⁰.
- 1238** Birth of Petronilla de la Lee [Corbet]⁵³⁷ in about 1238, in Moreton Corbet, Shropshire, England.
- 1245** Marriage of Alleman Sgr. of Bordeaux Du Puy III⁵⁴⁶ and Beatrix Tournon Du Puy [Artod]⁵⁴⁷.
- 1250** Birth of Chevalier Alleman Du Puy IV⁵⁴² in Drome, Rhone-Alpes, France.
- 1258** Death of Sir Fulk Marcher Lord of Whittington and Alveston FitzWarin III⁵⁵² in Whittington, Shropshire, England.
Death of Sir Thomas de la Lee⁵³⁶ in Salop, Shropshire, England.
- 1275** Birth of Eleanore Alleman Du Puy [de Lancoil]⁵⁴³.
- 1285** Marriage of Chevalier Alleman Du Puy IV⁵⁴² and Eleanore Alleman Du Puy [de Lancoil]⁵⁴³.
- 1290** Birth of Lord Alleman Du Puy V⁵³⁸ in Pereins, Drôme, Rhone-Alpes, France.
- 1293** Death of Beatrix Tournon Du Puy [Artod]⁵⁴⁷ in France.
- 1301** Death of Sir John "John Lee Esquire" de la Lee⁵⁴⁰ in Cheshire, England.
- 1304** Death of Alleman Sgr. of Bordeaux Du Puy III⁵⁴⁶ on 23 September, in France.
- 1310** Birth of Ainarde Du Puy [De Roland]⁵³⁹ in Pereins, France.
- 1311** Birth of Margaret de la Lee⁵³³ between 1311 and 1371.
- 1319** Death of Petronilla de la Lee [Corbet]⁵³⁷ in Alderton, Gloucestershire, England.
- 1321** Death of Eleanore Alleman Du Puy [de Lancoil]⁵⁴³.
- 1325** Marriage of Lord Alleman Du Puy V⁵³⁸ and Ainarde Du Puy [De Roland]⁵³⁹.
- 1326** Birth of John de la Lee II⁵³² between 1326 and 1366.
- 1329** Death of Chevalier Alleman Du Puy IV⁵⁴².
- 1330** Birth of Gilles Lord of Rochefort Du Puy I, Knight⁵³⁴ in Rochefort, Allier, Auvergne, France.
- 1335** Birth of Alix Du Puy [de Bellecombe]⁵³⁵ in Pereins, France.
- 1354** Birth of Margaret "Margaret de Astley" de Lee [Astley]⁵²⁹ in about 1354, in Coton Hall, Nordley Regis, Shropshire, England.
- 1360** Marriage of Gilles Lord of Rochefort Du Puy I, Knight⁵³⁴ and Alix Du Puy [de Bellecombe]⁵³⁵.
- 1362** Death of Lord Alleman Du Puy V⁵³⁸ in Rochefort, Allier, Auvergne, France.
Death of Ainarde Du Puy [De Roland]⁵³⁹ in France.
- 1366** Birth of Gillies Lord of Pereins Du Puy II⁵³⁰ in Pereins, Drome (Drôme), France.

- 1374** Birth of Petronella "Petronilla Of Lampley /De Lee/" Lee [Pimhall] "⁵²⁵ in Langley, Cheshire, England.
- 1376** Birth of Roger "Robert" de Lee⁵²⁸ in about 1376, in Roden, Stanton, Shropshire, England.
- 1378** Birth of Lady Marie Florence Du Puy [de Hauteville]⁵³¹ in Peyrins, (Drôme), Rhone-Alps, France.
- 1390** Death of Alix Du Puy [de Bellecombe]⁵³⁵ in France.
- 1392** Birth of Robert "Robert /De Lee/" Lee "⁵²⁴ in about 1392, in Coton, Nordley Regis, Shropshire, England.
- 1397** Death of Gilles Lord of Rochefort Du Puy I, Knight⁵³⁴ in Pereins, Drôme, Ardèche, Rhône-Alpes (Règion), France.
- 1400** Birth of Sir Richard DuPre⁵²⁶ in France.
- 1405** Birth of Paschale DuPre [DeVermondois]⁵²⁷ in Vermandois, France.
- 1420** Death of Gillies Lord of Pereins Du Puy II⁵³⁰ on 13 May, in France.
Death of Roger "Robert" de Lee⁵²⁸ in Nordley Regis, Shropshire, England.
- 1423** Death of Margaret "Margaret de Astley" de Lee [Astley]⁵²⁹ in Nordley Regis, Shropshire, England.
- 1424** Death of John de la Lee II⁵³².
- 1425** Birth of Isabella Lee [Ridley]⁵²⁰ in Alkington, Shropshire, England.
- 1429** Death of Robert "Robert /De Lee/" Lee "⁵²⁴ in Langley, Shropshire, England.
- 1430** Birth of Nicolas Brett⁵¹⁶ in Kelle, Staffordshire, England.
- 1432** Birth of Sir Richard "Recardus /De Lee/Lee" Lee Lee"⁵¹⁴ in Langley, Shropshire, England.
- 1433** Birth of Sir Josias DuPre⁵²¹ in Paris, Ile-de-France (Île-de-France), France.
- 1435** Birth of Lady Maria DuPre [Esteves]⁵²² in Bourgogne, France.
Birth of Agnes DuPre [Villiers]⁵¹⁸ in France.
- 1438** Birth of Radolphus "Ralph de Lee" Lee⁵¹⁹ between 1438 and 1447, in Langley, Shropshire, England.
- 1441** Birth of Margery Sprencheaux Lee [Sprencheaux]⁵¹⁵ in Donnington, Shropshire, England.
- 1442** Death of Petronella "Petronilla Of Lampley /De Lee/" Lee [Pimhall] "⁵²⁵ in England.
- 1460** Birth of Thomas Brett⁵¹⁰ in Dimmesdale, Wolstanton, Staffordshire, England.
- 1463** Birth of Jaques Henre DuPre II⁵¹⁷ in France.
- 1464** Birth of Mrs Brett [Baginholde]⁵¹¹.
- 1470** Birth of Sir John Clois Clowes Clewlowe Clulow⁴⁹⁰ in Rudyard, Staffordshire, England.
- 1471** Death of Sir Richard DuPre⁵²⁶ in Bourgogne, France.
- 1473** Birth of Lady Isabell Clois Clowes Clewlowe Clulow⁴⁹¹.
- 1475** Death of Lady Maria DuPre [Esteves]⁵²² in Bourgogne, France.
- 1477** Death of Lady Marie Florence Du Puy [de Hauteville]⁵³¹ in Pereins, (Drôme), Rhone-Alps, France.
- 1479** Death of Radolphus "Ralph de Lee" Lee⁵¹⁹ on 14 December, in Langley, Shropshire, England.

- 1484** Birth of Johanna Lee [Morton]⁵⁰⁹ in Haughton, Shropshire, England.
- 1487** Birth of Ann Brett [Woode]⁵⁰³ in about 1487, in Keele, Staffordshire, England.
- 1490** Birth of Jaques "James" Henre DuPre⁵¹² in Paris, France.
- 1492** Birth of Randolphe Brett⁵⁰² in Dimmesdale, Wolstanton, Staffordshire, England.
- 1494** Birth of Sir Thomas Lee⁵⁰⁸ in about 1494, in Langley, Acton Burnell, Shropshire, England.
- 1496** Birth of Anonette DuPre [Gaillard]⁵¹³ in Paris, Ile-de-France (Île-de-France), France.
- 1500** Birth of Laurence Woodall⁴⁸⁰ in Milton Keynes, Buckinghamshire, England.
- 1505** Birth of Sir Humphrey "Humphrey De Lee" Lee⁵⁰⁰ in about 1505, in Coton Hall, Alveley Parish, Nordley Regis, Shropshire, England.
- 1506** Birth of Katherine Lee [Blount]⁵⁰¹ in about 1506, in Yeo, Hereford, England.
- 1507** Death of Sir Josias DuPre⁵²¹ in Paris, Ile-de-France (Île-de-France), France.
Birth of Agnes Woodall [Inu/Light] Light⁴⁸¹ in Milton Keynes, Buckinghamshire, England.
Death of Jaques Henre DuPre II⁵¹⁷ in Nièvre (Nièvre), Bourgogne, France.
- 1508** Death of Sir Richard "Recardus /De Lee/Lee" Lee Lee⁵¹⁴ in England.
- 1512** Death of Margery Sprencheaux Lee [Sprencheaux]⁵¹⁵ in Willington, Durham, England.
- 1517** Birth of Louis Claude DuPre I⁵⁰⁴ in Paris, France.
Birth of Alice DuPre [Jospin]⁵⁰⁵ in France.
- 1518** Birth of Edward Brett⁴⁹⁴ in about 1518, in Keele, Staffordshire, England.
Marriage of Randolphe Brett⁵⁰² and Ann Brett [Woode]⁵⁰³ in about 1518, in Keele, Staffordshire, England.
- 1522** Birth of Cissely Brett [Fitton]⁴⁹⁵ in about 1522, in Keele, Staffordshire, England.
- 1526** Death of Sir Thomas Lee⁵⁰⁸ on 16 March, in Nordley Regis, Shropshire, England.
Death of Johanna Lee [Morton]⁵⁰⁹ in Nordley Regis, Shropshire, England.
- 1530** Birth of Sir John "John Lee Esquire" Lee⁴⁹² in about 1530, in Coton Hall, Nordley Regis, Shropshire, England.
- 1533** Birth of Louis Claude DuPre II⁴⁹⁶ in Paris, Ile-de-France, France.
Birth of Suzanne DuPre [Moeze]⁴⁹⁷.
- 1534** Birth of Hans Francke⁵⁰⁶ in Alfoldern, Wldck., Germany.
- 1538** Birth of Eva Francke⁵⁰⁷ in Alfoldern, Wldck., Germany.
- 1542** Birth of Joyce Lee [Romney]⁴⁹³ in Lulsley, Worcester, England.
- 1543** Death of Anonette DuPre [Gaillard]⁵¹³ in France.
- 1544** Birth of Randle Brett Britt⁴⁸⁴ in Keele, Staffordshire, England.
- 1545** Birth of Richard Woodall⁴⁷⁰ in Warwickshire, England.
Birth of Margaret Britt [Chetwynd]⁴⁸⁵ in Ingestre, Staffordshire, England.
- 1550** Death of Sir John Clois Clowes Clewlowe Clulow⁴⁹⁰ in about 1550, in Rudyard, Staffordshire, England.
- 1553** Birth of Mary Woodall [Ithell]⁴⁷¹.

- 1556** Death of Laurence Woodall⁴⁸⁰ in Buckinghamshire, England.
- 1557** Death of Agnes Woodall [Inu/Light] Light⁴⁸¹ on 25 August, in Sulton Benger, Wiltshire, England.
- 1559** Birth of Catherina Francke [Leimbach]⁴⁹⁹ in Heldra, Hessen-Nassau, Germany.
- 1561** Birth of Louis DuPre⁴⁸⁶ in Paris, Ile-de-France, France.
- 1563** Birth of Richard Lee⁴⁸² on 10 June, in Coton Hall, Nordley Regis, Shropshire, England.
- 1566** Birth of Hermann Francke⁴⁹⁸ on 16 March, in Heldra, Hessen-Nassau, Germany.
Marriage of Randle Brett Britt⁴⁸⁴ and Margaret Britt [Chetwynd]⁴⁸⁵ in about 1566, in Ingestre, Staffordshire, England.
- 1567** Death of Jaques "James" Henre DuPre⁵¹² in Paris, Ile-de-France (Île-de-France), France.
Birth of Elizabeth Lee [Bendey]⁴⁸³ in Shrophire, England.
- 1568** Death of Ann Brett [Woode]⁵⁰³ in St. Olave, Hart Street, London, England.
- 1569** Birth of Surgeon General John Woodall⁴⁵⁷ in London, England.
- 1570** Birth of Elizabeth DuPre [Gonzales]⁴⁸⁷ in Spain.
Birth of Sara Woodall [Staelie]⁴⁵⁸.
- 1572** Death of Louis Claude DuPre I⁵⁰⁴ in Manche, Basse-Normandie, France.
- 1573** Birth of Thomas Brett Britt⁴⁷⁴ in about 1573, in Ingestre, Staffordshire, England.
- 1575** Death of Hans Francke⁵⁰⁶ on 3 January, in Alfoldern, Wldck., Germany.
- 1579** Death of Eva Francke⁵⁰⁷ on 20 May, in Alfoldern, Wldck., Germany.
- 1580** Birth of John Lee Sr.⁴⁷² in Nordley Regis, Salop, England.
- 1583** Death of Edward Brett⁴⁹⁴ in Dimmesdale, Wolstanton, Staffordshire, England.
Death of Randle Brett Britt⁴⁸⁴.
- 1584** Birth of Ursula Britt [Coward]⁴⁷⁵.
- 1589** Death of Sir Humphrey "Humphrey De Lee" Lee⁵⁰⁰ on 12 March, in Nordley Regis, Shropshire, England.
- 1590** Death of Catherina Francke [Leimbach]⁴⁹⁹.
Birth of Margeurite DuPre [Bessonnet]⁴⁷⁷ in Ille-et-Vilaine, France.
Birth of Hans Francke Francke⁴⁸⁸ in Thüringen, Deutschland, Germany.
Birth of Ms. Francke⁴⁸⁹.
- 1591** Death of Hermann Francke⁴⁹⁸.
Death of Katherine Lee [Blount]⁵⁰¹ on 20 August, in Nordley Regis, Shropshire, England.
- 1594** Birth of Jane Lee [Hancock]⁴⁷³ in Twing, England.
- 1597** Birth of Jean DuPre⁴⁷⁶ on 20 February, in Ille-et-Vilaine, France.
- 1598** Death of Richard Woodall⁴⁷⁰ on 20 June, in Warwick, Warwickshire, England.
- 1603** Birth of Elizabeth Susan Brett [Gosling]⁴⁶².
Birth of Edmund Brett⁴⁶¹ in about 1603, in Bury St. Edmunds, Suffolk County, England.
- 1604** Death of Ursula Britt [Coward]⁴⁷⁵.

1604 (Continued)

Marriage of Thomas Brett Britt⁴⁷⁴ and Ursula Britt [Coward]⁴⁷⁵ on 5 July.

1605

Death of Sir John "John Lee Esquire" Lee⁴⁹² in June, in Regis Nordley, Shropshire, England.

1609

Death of Joyce Lee [Romney]⁴⁹³ on 4 December, in Alveley, Coton Nordley Register, Shropshire, England.

1612

Death of Louis Claude DuPre II⁴⁹⁶ in Manche, Basse-Normandie, France.

1616

Birth of John Lee II⁴⁶⁸ on 19 September, in St. Martin's Parish, Worcestershire, England.

1618

Birth of Colonel Richard Henry Lee⁴⁵⁹ on 22 March, in Coton Hall, Nordley Regis, Shropshire, England.

1621

Birth of Johannes Francke⁴⁷⁸ on 5 March, in Langenhessen, Zwickau, Sachsen, Germany.

Death of Richard Lee⁴⁸² in Alveley Parish, Shropshire, England.

1622

Birth of Ann Lee [Constable]⁴⁶⁰ in London, Middlesex, England.

Birth of Thomas Lee⁴⁶⁹.

Death of Louis DuPre⁴⁸⁶ in La Rochelle, Manche, Basse-Normandie, France.

1623

Birth of Barthelemy DuPre⁴⁶⁴ in Lot-et-Garonne, France.

Death of Margeurite DuPre [Bessonnet]⁴⁷⁷ in Saone-et-Loire (Saône-et-Loire), Bourgogne, France.

1625

Birth of Anna Francke [Gloxin]⁴⁷⁹ on 25 July, in Lubeck, Germany.

1627

Birth of Dr. John William Woodall⁴³⁹ on 22 July, in St Benet Fink, Hemingbrough Yorkshire, England.

1628

Birth of Elizabeth Brett [Lowe]⁴⁶³ in about 1628, in Prince George County, Maryland.

1630

Death of John Lee Sr.⁴⁷² on 23 February, in Worcester, Worcestershire, England.

Death of Elizabeth Lee [Bendey]⁴⁸³ on 12 April, in Alveley, Shropshire, England.

Birth of Sarah Woodall [Henchpole]⁴⁴⁰.

Birth of Matilda DuPree [Robin]⁴⁶⁵ in France.

Death of Elizabeth DuPre [Gonzales]⁴⁸⁷ in Spain.

1631

Birth of Ann Brett [Woodward]⁴⁴⁵ in about 1631, in Worcestershire, England.

1633

Death of John Lee II⁴⁶⁸.

Birth of Susan Brett Britt⁴⁵³ on 24 November, in Rattlesden, Suffolk County, England.

1635

Birth of John Brett⁴⁴³ on 7 March, in Rattlesden, Suffolk County, England.

Birth of Elizabeth Brett Britt⁴⁵⁴ on 7 March, in Rattlesden, Suffolk County, England.

Birth of William Brett Jr.⁴⁵⁵ in Kent, Sussex County, England.

1636

Death of Thomas Lee⁴⁶⁹.

1637

Birth of William Brett⁴⁵⁶ on 8 January, in Rattlesden, Suffolk County, England.

1638

Death of Jane Lee [Hancock]⁴⁷³ in England.

1641

Death of Sara Woodall [Staelie]⁴⁵⁸ in September.

1643

Death of Surgeon General John Woodall⁴⁵⁷ on 28 August, in London, England.

1646

Death of Hans Francke Francke⁴⁸⁸.

1651

Birth of William Lee⁴⁴¹ in Northumberland, Virginia.

1654

Birth of Josias "Joseph" Crancie Dupree⁴⁴⁷ in Haute-Saone (Haute-Saône), France.

1654 (Continued)

Death of Matilda DuPree [Robin]⁴⁶⁵ in France.

1655

Birth of Alice Lee [Felton]⁴⁴² in Virginia.

Birth of Edward Mashborne Mashburn Sr.⁴³³ in about 1655, in St Giles Parrish, London, England.

1656

Death of Margaret Britt [Chetwynd]⁴⁸⁵.

Birth of Sarah Mashburn [Sindery]⁴³⁴ in St Giles Parrish, London, England.

Birth of Mynetta "Mary" Denizot Dupree [Lamoreaux]⁴⁴⁸ in Cannes, Gard, Languedoc-Roussillon, France.

1657

Birth of Elizabeth Brett [Waters]⁴⁴⁴ in Boston, Suffolk County, Massachusetts.

1661

Marriage of John Brett⁴⁴³ and Ann Brett [Woodward]⁴⁴⁵ in Rattlesden, Suffolk County, England.

1663

Birth of August Hermann Francke⁴⁶⁶ on 22 March, in Lubeck, Germany.

Death of Johannes Francke⁴⁷⁸ in Lübeck, Schleswig-Holstein, Deutschland, Germany.

1664

Death of Colonel Richard Henry Lee⁴⁵⁹ on 1 March, in Dividing Creek, Northumberland, Virginia.

1669

Birth of John Brett⁴²⁵ on 26 February, in Rattlesden, Suffolk County, England.

1670

Birth of Richard Henry Lee⁴²³ in England.

Birth of Mary Lee [Young]⁴²⁴ in England.

Birth of Anna Magdalena Francke [von Wurmb]⁴⁶⁷ on 19 November, in Kleinfurra, Thuringia, Germany.

1671

Death of Elizabeth Susan Brett [Gosling]⁴⁶² on 16 September.

Marriage of Edmund Brett⁴⁶¹ and Elizabeth Brett [Lowe]⁴⁶³ on 30 November, in Rattlesden, Suffolk County, England.

1672

Birth of Nathaniel Brett⁴³⁶ on 23 June, in Rattlesden, Suffolk County, England.

1674

Death of Edmund Brett⁴⁶¹ in Suffolk County, England.

Death of Jean DuPre⁴⁷⁶ on 7 November, in Saone-et-Loire (Saône-et-Loire), Bourgogne, France.

1675

Birth of Samuel Mashburn⁴¹⁸ on 9 January.

Birth of Elizabeth Mashburn [Rhodes]⁴⁰⁹ in North Carolina.

Birth of John Martin Franck⁴⁴⁹ on about 1 June, in Salsburg, Bavarian, Palatinate Section, Germany.

1676

Birth of Edward Mashborne Mashburn Jr.⁴⁰⁸ on 27 May, in St Giles Parrish, London, England.

Marriage of Edward Mashborne Mashburn Sr.⁴³³ and Sarah Mashburn [Sindery]⁴³⁴ on 16 August, in St. Dunston, East London, England .

1677

Birth of Mary Brett⁴³⁷ on 25 March, in Rattlesden, Suffolk County, England.

1678

Birth of John Woodall⁴²¹ in Henrico County, Virginia.

Marriage of John Brett⁴⁴³ and Elizabeth Brett [Waters]⁴⁴⁴ in Hurstmonceux, Sussex, England.

1679

Birth of James Brett⁴³⁸ on 5 October, in Rattlesden, Suffolk County, England.

1680

Birth of Sarah Woodall [Stanley]⁴²² in Virginia.

Death of Dr. John William Woodall⁴³⁹ in Westminster, London, England.

Birth of Sarah Mashburn⁴¹⁹ on 25 August.

Birth of Susannah Brett [Bressie]⁴⁴⁶ in about 1680, in Isle of Wight County, Virginia.

1683

Birth of Matthew Mashburn⁴²⁰ in London, Middlesex, England.

Birth of Loys "Louis" Dupree⁴²⁷ in La Rochelle, Manche, Brasse-Normandie, France.

1685

Death of Sarah Mashburn [Sindery]⁴³⁴.

1686

Birth of Larance Lara Dupree [Ellerbee]⁴²⁸ in Lunenburg, Virginia.

- 1687** Birth of John Thomas Speight⁴⁵¹ in Isle of Wright County, near South Quay, Virginia.
- 1688** Birth of Ann Brett [Barnsdale (Barnsdell)]⁴²⁶ on 1 February, in Boston, Suffolk County, Massachusetts.
- 1689** Birth of Capt. John Esquire Lee³⁹⁶ in New Kent, Virginia.
Birth of Elizabeth Spaight [Powell]⁴⁵² in Kingsland, Herefordshire, England.
- 1690** Birth of Mary Lee [Bryan]³⁹⁷.
Death of Mynetta "Mary" Denizot Dupree [Lamoreaux]⁴⁴⁸ in September, in France.
- 1691** Baptist: Elizabeth Spaight [Powell]⁴⁵² on 30 August, in Kingsland, Herefordshire, England.
- 1694** Birth of Sevil Civil Franck [Timmerman]⁴⁵⁰ in Bayern, Germany.
- 1699** Marriage of John Brett⁴⁴³ and Susannah Brett [Bressie]⁴⁴⁶ in isle of Wight County, Virginia.
- 1701** Death of Barthelemy DuPre⁴⁶⁴ in Virginia.
- 1702** Marriage of Edward Mashborne Mashburn Jr.⁴⁰⁸ and Elizabeth Mashburn [Rhodes]⁴⁰⁹ in about 1702.
- 1703** Birth of Sarah Mashburn³⁸⁷ in Northampton County, North Carolina.
Death of Alice Lee [Felton]⁴⁴² in Virginia.
Birth of Matthew Mashburn³⁸⁶ in Nansemond, Virginia.
- 1706** Death of Ann Lee [Constable]⁴⁶⁰ on 6 October, in Northumberland, Virginia.
- 1709** Death of William Lee⁴⁴¹ on 25 May, in Suit, King Queen, Virginia.
Death of Anna Francke [Gloxin]⁴⁷⁹ in June, in Gotha, Thuringen, Germany.
Birth of William Woodall Sr.⁴¹¹.
- 1710** Marriage of John Brett⁴²⁵ and Ann Brett [Barnsdale (Barnsdell)]⁴²⁶ on 29 June, in Boston, Suffolk County, Massachusetts.
Birth of John Issac Woodall³⁹⁴ in Goochland, Virginia.
- 1711** Birth of Hannah Britt⁴¹³ on 9 May, in Boston, Suffolk County, Massachusetts.
Death of William Brett⁴⁵⁶ in Nansemond County, Virginia.
- 1712** Death of Elizabeth Mashburn [Nash]⁴¹⁰ in London, England.
Death of Edward Mashborne Mashburn Sr.⁴³³ on 12 October, in St. Giles Parrish, London, England.
- 1713** Death of William Brett Jr.⁴⁵⁵ in Bridgewater, Plymouth County, Massachusetts.
Birth of John Britt Jr.³⁹⁸ on 22 July, in Boston, Suffolk County, Massachusetts.
- 1714** Birth of Captain William Spaight⁴³¹ in Isle of Wright, Nanesmond, Virginia.
- 1715** Birth of Freelove Britt [Fenno]³⁹⁹ on 1 February, in Dorchester, Norfolk County, Massachusetts.
- 1717** Birth of Sarah Prior [Woodall]⁴¹².
- 1718** Death of John Brett⁴⁴³ in about 1718, in Isle of Wight County, Virginia.
- 1719** Birth of William Brett Britt⁴¹⁴ on 20 January, in Boston, Suffolk County, Massachusetts.
- 1721** Birth of Jacob Miller Franks⁴²⁹ in Craven County, North Carolina.
- 1723** Marriage of Matthew Mashburn³⁸⁶ and Sarah Mashburn³⁸⁷.
- 1724** Birth of Abigail Spaight [Westropp]⁴³² in Johnston County, North Carolina.
- 1725** Birth of Mary Ann Franks [Ashley]⁴³⁰ in Province of, North Carolina.

1725 (Continued)

Birth of Edward G Lee³⁷³ in Virginia.

1726

Birth of Mary Lee [Allen]³⁷⁴ in Virginia.

Death of Richard Henry Lee⁴²³ in King Queen (King and Queen), Virginia.

1727

Death of August Hermann Francke⁴⁶⁶ on 8 June, in Halle, Germany.

Birth of Haley Dupree⁴⁰² in Pitt County, North Carolina.

1728

Birth of Mary Britt [Moody]⁴⁰⁰ in Newburyport, Essex County, Massachusetts.

1731

Birth of Joseph Britt³⁷⁵ on 16 June, in Canterbury, Windham County, Connecticut.

Marriage of John Issac Woodall³⁹⁴ and Judith Woodall [Sampson]³⁹⁵ in Goochland County, Virginia.

1732

Marriage of John Britt Jr.³⁹⁸ and Freeloove Britt [Fenno]³⁹⁹ on 20 January.

1734

Death of Anna Magdalena Francke [von Wurmb]⁴⁶⁷ on 19 March, in Halle, Saxony-Anhalt, Germany.

Death of Larance Lara Dupree [Ellerbee]⁴²⁸ in Brunswick, Virginia.

1735

Birth of Olive Britt [Davis]³⁷⁷ in about 1735, in Virginia or Massachusetts.

Birth of Winifred Britt [Connolly]⁴⁰¹ in about 1735, in Prince William County, Virginia.

1736

Death of Freeloove Britt [Fenno]³⁹⁹.

1738

Death of John Brett⁴²⁵ on 23 May, in (will Filed) in Bertie Co, North Carolina.

Death of John Thomas Speight⁴⁵¹ in Suffolk County, Virginia.

1739

Death of Edward Mashborne Mashburn Jr.⁴⁰⁸ on 22 April, in Onslow County, North Carolina.

Death of Elizabeth Spaight [Powell]⁴⁵² in Isle of Wright, Virginia.

Birth of James Lane⁴⁰⁶ in Halifax County, North Carolina.

1740

Birth of Jacob Woodall³⁷¹ in Goochland County, Virginia.

Birth of Ms. Britt³⁷⁶ in about 1740, in Virginia or North Carolina.

Death of Susannah Brett [Bressie]⁴⁴⁶ in about 1740.

1743

Birth of Lydia Lane [Speight]⁴⁰⁷ on 24 April, in Edgecomb County, North Carolina.

1744

Death of John Martin Franck⁴⁴⁹ on 3 November, in Craven County, North Carolina.

1745

Marriage of Edward G Lee³⁷³ and Mary Lee [Allen]³⁷⁴.

1747

Death of Sarah Woodall [Stanley]⁴²² in Goochland, Goochland County, Virginia.

Marriage of John Britt Jr.³⁹⁸ and Mary Britt [Moody]⁴⁰⁰ on 10 September.

1748

Death of Loys "Louis" Dupree⁴²⁷ on 12 July, in Brunswick, Virginia.

1749

Birth of Martha Franks [Cook]⁴⁰⁵ in Province of, North Carolina.

1750

Death of John Woodall⁴²¹ on 19 March, in Goochland, Virginia.

Birth of Anthony Franks⁴⁰⁴.

Birth of Agnes Woodall [Hicks]³⁷² in Goochland, Goochland County, Virginia.

1752

Death of Sevil Civil Franck [Timmerman]⁴⁵⁰ in Jones County, North Carolina.

1753

Birth of Lemuel Samuel "Lom" Lee³⁵⁴ on 5 March, in North Carolina.

1755

Birth of Ann Lee [Rains]³⁵⁵ in Johnston County, North Carolina.

1756

Birth of John Britt³⁸⁹ on 11 July, in Newbury, Essex County, Massachusetts.

1756 (Continued)

Marriage of John Britt Jr.³⁹⁸ and Winifred Britt [Connolly]⁴⁰¹ on 9 October, in Goochland County, Virginia.

1757

Birth of Pvt Daniel Mashburn³⁶⁸.

1758

Birth of James Britt³⁹⁰ on 9 July, in Goochland County, Virginia.

1759

Birth of Haley Dupree II³⁷⁸.

1760

Marriage of James Lane⁴⁰⁶ and Lydia Lane [Speight]⁴⁰⁷ in Halifax County, North Carolina.

Death of Matthew Mashburn³⁸⁶ on 1 July, in Northampton County, North Carolina.

Birth of Daniel Britt³⁹¹ on 28 September, in Goochland County, Virginia.

1763

Marriage of Jacob Woodall³⁷¹ and Agnes Woodall [Hicks]³⁷².

Birth of Milly Britt³⁹² on 19 July, in Goochland County, Virginia.

1765

Birth of Lewis Emery⁶⁴⁸.

Birth of Nancy Britt [Stephens]³⁵⁷ in Duplin County, North Carolina.

1766

Birth of Molly Britt³⁹³ on 10 January, in Goochland County, Virginia.

Death of Capt. John Esquire Lee³⁹⁶ on 4 December, in North Carolina.

1767

Birth of John Adams³⁶⁰ on 19 May, in Cumberland County, North Carolina.

Birth of Jacob B. Woodall³⁵² in Johnston County, North Carolina.

1770

Death of Winifred Britt [Connolly]⁴⁰¹ in Goochland County, Virginia.

Birth of Lucy Phereby Woodall [Gower]³⁵³ in North Carolina.

Birth of Nathaniel M. Lane³⁸⁴ on 11 November, in Wake County, North Carolina.

1773

Death of Agnes Woodall [Hicks]³⁷² in North Carolina.

Birth of Delphia Mashburn [Warren]³⁶⁹ in about 1773, in Northampton County, North Carolina.

1774

Death of Captain William Spaight⁴³¹ in May, in Halifax, Virginia.

Birth of Joseph Britt Jr.³⁵⁶ in Wake County, North Carolina.

Birth of Delilah Adams [Green]³⁶¹ in about 1774.

1775

Death of Edward G Lee³⁷³ in North Carolina.

Marriage of Lemuel Samuel "Lom" Lee³⁵⁴ and Ann Lee [Rains]³⁵⁵.

1777

Birth of Lewis Henry Franks³⁸⁰ in Wake County, North Carolina.

Birth of Kizzie Dupree [Young]³⁵⁹ in about 1777, in Virginia.

1779

Birth of Elizabeth Lane [Smith]³⁸⁵ on 31 January, in Wake County, North Carolina.

1780

Birth of Sarah Franks [Freeman]³⁸¹ in Wake County, North Carolina.

Birth of John W Perry³⁶⁶ on 15 November, in Chatham County, North Carolina.

1781

Death of Abigail Spaight [Westropp]⁴³² on 17 January.

Birth of Henry "Harry" Lee³³⁰ in Johnston County, North Carolina.

1783

Birth of Sally Lee [Coats]³³¹ in about 1783.

1784

Birth of Henry Dupree³⁵⁸ in Greenville, Southampton County, Virginia.

Birth of Nancy Ann Perry [Baker]³⁶⁷ in Franklin County, North Carolina.

1785

Birth of Elizabeth Emery⁶⁴⁹.

1787

Death of William Brett Britt⁴¹⁴ on 4 January, in Goochland County, Virginia.

1788

Marriage of Joseph Britt³⁷⁵ and Olive Britt [Davis]³⁷⁷ on 26 January, in Wake County, North Carolina.

1789

Death of Mary Ann Franks [Ashley]⁴³⁰ in Virginia.
 Marriage of Jacob B. Woodall³⁵² and Lucy Phereby Woodall [Gower]³⁵³ on 16 December.

1790

Marriage of Joseph Britt Jr.³⁵⁶ and Nancy Britt [Stephens]³⁵⁷ on 16 November, in Wake County, North Carolina.

1792

Death of Mary Lee [Bryan]³⁹⁷.

1794

Death of Jacob Miller Franks⁴²⁹ in Kentucky.

1797

Birth of Austin Jones³⁶⁴.
 Death of William Woodall Sr.⁴¹¹ in August.
 Death of John Britt Jr.³⁹⁸ on 12 December, in Newburyport, Essex County, Massachusetts.

1799

Death of Joseph Britt³⁷⁵ in Isle of Wight County, Virginia.

1800

Birth of James Gower Woodall³²⁸ on 29 May.
 Birth of Charlotte Britt [Penny]³³³ in Wake County, North Carolina.
 Birth of Hardy Britt³³² in Wake County, North Carolina.
 Death of Mary Lee [Allen]³⁷⁴ on 20 October.

1802

Birth of Sarah "Sally" Woodall [Barber]³²⁹ in North Carolina.

1803

Birth of Joseph Adams³³⁸ on 8 May.
 Birth of Anthony Franks³⁶².
 Birth of William Marshburn³⁴⁶ in about 1803.

1804

Birth of Talitha Adams [Johnson]³³⁹ on 3 March.

1805

Death of James Lane⁴⁰⁶ on 6 January, in Wake County, North Carolina.
 Birth of Anna Franks [Hunter]³⁶³.
 Death of Lydia Lane [Speight]⁴⁰⁷ in Wake County, North Carolina.

1807

Death of Haley Dupree⁴⁰².
 Birth of Ephraim Emery⁶⁴⁶ in Wake County, North Carolina.
 Birth of James Dupree³⁴⁸.

1808

Death of Jacob Woodall³⁷¹ in Johnston County, North Carolina.

1809

Death of John Issac Woodall³⁹⁴ in Franklin, Virginia.
 Birth of Thomas Jefferson Dupree³³⁶ in about 1809.

1810

Birth of Allie Oliver Dupree [Gregory]³³⁷ in February.
 Marriage of Henry "Harry" Lee³³⁰ and Sally Lee [Coats]³³¹ in about 1810.

1812

Birth of Martha Ann Jones [Lane]³⁶⁵.

1814

Birth of Susan Marshburn [Ellis]³⁴⁷ in about 1814.

1815

Death of Elizabeth Lane [Smith]³⁸⁵ on 25 September.

1816

Birth of Nathaniel Dupree³⁵⁰ in April.
 Birth of Grace Dupree [Blalock]³⁴⁹.

1817

Birth of Margaret Emery⁶⁴⁷ in North Carolina.

1820

Death of Anthony Franks⁴⁰⁴ in Wake County, North Carolina.
 Birth of Ransom Lee³⁰⁶ on 29 August, in Johnston County, North Carolina.

1821

Death of Ann Lee [Rains]³⁵⁵ in Johnston County, North Carolina.

1821 (Continued)

Marriage of James Gower Woodall³²⁸ and Sarah "Sally" Woodall [Barber]³²⁹ on 10 August.

1823

Marriage of Hardy Britt³³² and Charlotte Britt [Penny]³³³ on 21 January, in Wake County, North Carolina.

1824

Birth of Elizabeth Dupree [Turlington]³⁵¹ on 2 May.

1825

Birth of John G Woodall³¹⁷.

1827

Death of Martha Franks [Cook]⁴⁰⁵ in Wake County, North Carolina.

1829

Birth of Burt A Woodall³⁰⁴ in Johnston County, North Carolina.

Birth of Robert Sidney Perry³⁴² on 27 August, in Wake County, North Carolina.

1830

Birth of Eliza Woodall [Wellons]³⁰⁵ in Johnston County, North Carolina.

Death of John Britt³⁸⁹ on 13 September, in Newburyport, Essex County, Massachusetts.

1831

Birth of Julia A. Perry [Speight]³⁴³ on 15 July, in Wake County, North Carolina.

1834

Birth of Lucy E Lee [Rose]³⁰⁷ on 22 February.

Birth of James "Jim" David Franks³⁴⁰ on 25 December.

1835

Birth of Edith Rebecca Britt [Young]³⁰⁹ on 12 May.

Marriage of William Marshburn³⁴⁶ and Susan Marshburn [Ellis]³⁴⁷ on 26 August.

1836

Birth of William H Dupree³¹⁹.

Birth of Emily Woodall [Eldridge]³¹⁸.

Birth of Julia Ann Dupree [Adams]³¹¹ on 22 October.

1837

Birth of Joseph Leonard Britt³⁰⁸ on 27 May, in Wake County, North Carolina.

Birth of Eugenia "Jane" Dupree [Stancil]³²⁰.

1838

Birth of Emma Gasten Franks [Jones]³⁴¹ on 7 March.

Birth of Joseph Dupree³²⁴.

1839

Birth of James G Dupree³¹⁰ on 24 May.

Death of Joseph Britt Jr.³⁵⁶ in Southampton County, Virginia.

Birth of Eliza Jane Dupree [Adams]³²⁵.

1840

Death of Daniel Britt³⁹¹ in Marion, Marion County, South Carolina.

1842

Birth of Jane Ellen Perry [Watkins]³⁴⁵ on 17 July, in Wake County, North Carolina.

1843

Birth of Issac R Durham⁶³² on 7 March.

Death of Lemuel Samuel "Lom" Lee³⁵⁴ on 15 September, in Johnston County, North Carolina.

1844

Birth of William Emory⁶⁴⁰ on 23 March, in Houses Creek, Wake County, North Carolina.

Birth of William Wright Wilson⁶⁴².

1847

Birth of William Moore⁶³⁸.

Birth of Laura Emory⁶⁴¹.

1848

Death of Pvt Daniel Mashburn³⁶⁸ on 31 January, in Wake County, North Carolina.

Death of John Adams³⁶⁰ in Cumberland County, North Carolina.

1849

Death of Jacob B. Woodall³⁵² in Johnston County, North Carolina.

1850

Death of Lewis Henry Franks³⁸⁰ in Wake County, North Carolina.

Death of Sarah Franks [Freeman]³⁸¹.

1850 (Continued)

Death of Nancy Ann Perry [Baker]³⁶⁷ in Wake County, North Carolina.

Death of Delilah Adams [Green]³⁶¹ in about 1850.

Death of Henry Dupree³⁵⁸ in about 1850.

1851

Death of Lucy Phereby Woodall [Gower]³⁵³ in Johnston County, North Carolina.

1852

Death of Nathaniel M. Lane³⁸⁴ on 5 July, in Wake County, North Carolina.

Birth of Susan Alice Marshburn [Parker]³¹⁶ on 3 November, in North Carolina.

1853

Death of John W Perry³⁶⁶.

1854

Birth of John Benton Dupree³²¹.

Marriage of Joseph Leonard Britt³⁰⁸ and Edith Rebecca Britt [Young]³⁰⁹ on 9 August.

Birth of Dr Berry Daniel Marshburn³¹⁵ on 16 August.

Birth of Caroline F Durham⁶³³ on 24 August.

Marriage of Burt A Woodall³⁰⁴ and Eliza Woodall [Wellons]³⁰⁵ on 2 November.

Marriage of Robert Sidney Perry³⁴² and Julia A. Perry [Speight]³⁴³ on 13 December.

1855

Birth of Troy Randolph Britt²⁷⁵ on 2 June.

1858

Birth of John Henry Quinn⁶³⁶ on 26 January.

Birth of William Nathaniel "Nat" Franks³¹² on 25 December, in Wake County, North Carolina.

1859

Birth of Susanna Kincaid Britt²⁷⁶ on 28 April.

Birth of Willis L. Woodall²⁷⁰.

1860

Birth of William "Anguish" Dupree²⁹⁸ on 3 February.

Death of Henry "Harry" Lee³³⁰ in Arkansas.

Death of Austin Jones³⁶⁴.

1861

Birth of Zeba Bunyan Britt²⁷⁷ on 21 February.

Birth of Edward Hale Woodall²⁶¹ on 26 May, in Johnston County, North Carolina.

Birth of Benjamine Franklin Dupree³²⁶ on 28 October.

Death of Delphia Mashburn [Warren]³⁶⁹ after 1861, in Probably Cumberlin County, North Carolina.

1863

Death of William H Dupree³¹⁹ on 5 January.

Birth of Fannie Telfer Dupree [Love]³²⁷ on 27 March.

Birth of Martha Charlotte Britt²⁷⁸ on 14 November.

Birth of Lugenia Elizabeth "Bettie" Dupree [Smith]²⁹⁹ on 2 December.

1864

Birth of Lorenda Arinda "Lora" Franks [Perry]³¹³ on 12 August, in Wake County, North Carolina.

1865

Birth of Leonard Lethco Britt²⁶³ on 29 April.

Birth of Mosley R H Franks³²² on 26 June.

Death of James Gower Woodall³²⁸ in Johnston County, North Carolina.

1866

Birth of Mary Francis Britt [Guy]²⁶⁴ on 2 July.

1868

Birth of Martha Caroline Dupree [Young]²⁶⁶ on 2 February.

Death of Julia A. Perry [Speight]³⁴³ on 11 July, in Wake County, North Carolina.

Marriage of Robert Sidney Perry³⁴² and Mitty Ann Perry [Horton]³⁴⁴ on 30 December.

1869

Birth of Luella Etta Britt²⁷⁹ on 7 November.

Birth of Charlie Benton Dupree²⁶⁵ on 26 December.

1870

Death of Mosley R H Franks³²² on 12 February.

Birth of William Adderson Watkins²⁶⁹ on 6 April.

Death of Charlotte Britt [Penny]³³³.

1871

Birth of Mary Elizabeth Franks³²³ on 14 May.
 Death of Anna Franks [Hunter]³⁶³.
 Death of Anthony Franks³⁶² in Wake County, North Carolina.
 Birth of Sarah Woodall [Lee]²⁶² on 13 December, in Johnston County, North Carolina.

1872

Birth of Neal Henry Moore⁶³⁰ in Rocky Mount, North Carolina.
 Birth of Joseph Burke Britt²⁸⁰ on 26 October.

1873

Birth of Cecil Ripton Wilson⁶³⁴ on 16 October.
 Marriage of Dr Berry Daniel Marshburn³¹⁵ and Susan Alice Marshburn [Parker]³¹⁶ in about 1873.

1874

Death of Joseph Leonard Britt³⁰⁸ on 20 May.

1876

Death of Talitha Adams [Johnson]³³⁹ on 14 May.
 Birth of Sophony Emery Moore⁶³¹.
 Death of Thomas Jefferson Dupree³³⁶ in about 1876.

1877

Birth of Rachel Stroud Quinn⁶³⁷ on 1 April.
 Death of Joseph Adams³³⁸ on 12 May.

1878

Death of Hardy Britt³³² in Wake County, North Carolina.
 Birth of John Franklin Woodall²⁹⁶ on 7 August.
 Birth of Rebecca Mathis Wilson⁶³⁵ on 26 October.

1880

Death of Troy Randolph Britt²⁷⁵ on 28 January.
 Death of Martha Ann Jones [Lane]³⁶⁵.
 Birth of Lalah Florence Dupree [Gardner]³⁰¹.

1882

Death of Ransom Lee³⁰⁶ in July, in Johnston County, North Carolina.

1883

Birth of Henry Quinton Dupree³⁰⁰.

1884

Birth of Samuel "Lattie" Franks²⁸² on 3 March, in McCullers, Wake County, North Carolina.
 Birth of Bettie Perry Franks [Spears]²⁸³ on 12 September.

1886

Birth of Vienna Jannetta Franks [Marshburn]²⁶⁸ on 27 January.
 Birth of Robert Larry Franks²⁶⁷ on 28 February, in McCullers, Wake County, North Carolina.
 Birth of Franklin Tell Dupree³⁰² on 4 April.

1887

Birth of Leddie Bain Franks²⁸⁴ on 28 July.

1889

Birth of Emma Foy Hayes [Franks]²⁸⁶ on 9 June, in McCullers, Wake County, North Carolina.
 Birth of Elizabeth "Lizzie" Dupree [Wells]³⁰³ on 15 September.

1890

Death of Julia Ann Dupree [Adams]³¹¹ on 11 February.
 Birth of Mattie Woodall [Creech]²⁹⁷.

1891

Marriage of Neal Henry Moore⁶³⁰ and Sophony Emery Moore⁶³¹.

1892

Birth of Grover Carr Franks²⁸⁷ on 13 March, in Wake County, North Carolina.
 Marriage of Edward Hale Woodall²⁶¹ and Sarah Woodall [Lee]²⁶² on 3 October.
 Death of Mary Elizabeth Franks³²³ on 6 October.
 Birth of Ottis Alden Dupree²¹⁷ on 8 October.
 Marriage of Charlie Benton Dupree²⁶⁵ and Martha Caroline Dupree [Young]²⁶⁶ in about 1892.

1893

Birth of Annie Sexton [Britt]²¹² on 3 June.
 Birth of Ruby Mable Beck [Franks]²⁸⁸ on 5 October.
 Birth of John Elmond Dupree Sr.²⁵¹ on 19 November.

1893 (Continued)

Birth of Gilbert Chesley Woodall¹⁹⁶ on 29 November, in Johnston County, North Carolina.

1894

Birth of Dorsey Benard Dupree²¹⁹ on 6 May.

Death of Burt A Woodall³⁰⁴.

1895

Birth of Lewis Nathaniel "Snooks" Franks²⁸⁹ on 27 April.

Death of John G Woodall³¹⁷.

1896

Birth of Hunter McGuire Woodall²⁰⁰ on 3 March, in Johnston County, North Carolina.

Birth of Ila Britt²¹³ on 24 May.

Birth of Ila Ann Adams [Dupree]²²¹ on 28 September.

1897

Birth of James Leslie Franks²⁹¹ on 28 April, in McCullers, Wake County, North Carolina.

Birth of William Anguish Dupree Sr.²⁵³ on 18 September.

Birth of Roy Neal Moore⁶²⁵ on 31 October.

1898

Birth of Lee Perry Franks²⁹² on 14 January, in McCullers, Wake County, North Carolina.

Birth of Fannie Lee Woodall [Goldston]²⁰¹ on 28 January, in Lee County, North Carolina.

Birth of Mallie Dupree [Ennis]²²⁰ on 2 March.

Birth of Bettie Vandon Dean [Woodall]²⁰² on 2 April, in Johnston County, North Carolina.

Birth of Alda Leland Woodall [Britt]¹⁹⁷ on 18 April, in North Carolina.

Birth of Madeline Clyde Woodall [Hocutt]²⁰⁶ on 2 May, in Wake County, North Carolina.

Birth of Silas Greene Adams²²² on 8 June.

Birth of Lydia Franks [Massey]²⁹⁰.

Death of Eliza Jane Dupree [Adams]³²⁵.

1899

Birth of Lillian "Lillie" Mary Franks [Godwin]²⁸⁵ on 6 April.

Birth of Fred Edward Dean²⁰³ on 19 April, in Franklin County, North Carolina.

Birth of Cary Melvin Dupree²²³ on 22 June.

Birth of Mamie Ethel Moore [Durham]⁶²⁶ on 7 October.

Birth of Rado Utah Ennis [Britt]²¹⁴ on 30 October.

1900

Birth of Lance H. Franks²⁹³ on 26 July, in McCullers, Wake County, North Carolina.

Birth of Mattie Dupree [Brickhouse]²⁵² on 10 October.

1901

Death of James Leslie Franks²⁹¹ in McCullers, Wake County, North Carolina.

Birth of Clida Lee Woodall²⁰⁴ on 28 September, in Johnston County, North Carolina.

1902

Birth of Mildred Dupree [Jones]²²⁴ on 9 April.

Birth of John Stuart Dupree¹⁹⁸ on 9 June.

Birth of Broughton C Britt²¹⁵ on 6 July.

1903

Birth of Leigh Edward Woodall²⁰⁵ on 2 July, in Johnston County, North Carolina.

1904

Death of Luella Etta Britt²⁷⁹ on 17 April.

Death of James "Jim" David Franks³⁴⁰ on 11 July.

Birth of Wayman Creech²²⁶ in about 1904.

1905

Birth of Ruth Naola Dupree²⁵⁴ on 28 June.

Death of Joseph Dupree³²⁴.

Birth of Myrtle Irene Dupree [Stephenson]²¹⁸.

Birth of Christopher Clinton Franks²⁹⁴ on 15 July, in McCullers, Wake County, North Carolina.

1906

Birth of "Graham" Hubbard Franks²⁴¹ on 8 June.

Death of Nathaniel Dupree³⁵⁰.

Birth of William Wells Wilson⁶²⁷ on 30 June.

Birth of Bert Albert Woodall²⁰⁷ on 31 August, in Johnston County, North Carolina.

Birth of Lois Creech [Dupree]²²⁵ in about 1906.

1907

Birth of Bettie Allene Franks [Barbour]²⁴² on 11 November.

1908

Death of Elizabeth Dupree [Turlington]³⁵¹ on 17 May.

Death of Lucy E Lee [Rose]³⁰⁷ on 18 May.

1909

Birth of Alpha Byon Franks²⁹⁵ on 14 February, in McCullers, Wake County, North Carolina.

Birth of Graham Dennis Shepard²⁴⁶ on 23 July.

Birth of Candice Mozelle Woodall [Fish]²⁰⁸ on 14 November.

Birth of Rex Kenneth Bradley²¹¹ on 29 November.

1910

Birth of Willis Lester Woodall²⁰⁹ on 7 March, in Johnston County, North Carolina.

Death of Edith Rebecca Britt [Young]³⁰⁹ on 14 August.

1911

Birth of Charles Glenn Dupree²²⁷ on 23 March.

Birth of Clyda Dupree [Young]²⁵⁶.

Birth of Alvis Holton Dupree²⁵⁵.

Birth of Effie Ray Wilson [Quinn]⁶²⁸ on 5 July.

Death of Issac R Durham⁶³² on 22 September, in Garner, North Carolina.

Birth of Dewitt Creech Woodall²⁴⁹ on 28 September.

1912

Death of James G Dupree³¹⁰ on 20 January.

Death of Lorenda Arinda "Lora" Franks [Perry]³¹³ on 1 June, in McCullers, Wake County, North Carolina.

Death of Jane Ellen Perry [Watkins]³⁴⁵ on 15 September, in Wake County, North Carolina.

1913

Birth of Ruby Larry Dupree [Franks]¹⁹⁹ on 20 April, in Wake County, North Carolina.

Birth of Sallie Muriel Bradley [Woodall]²¹⁰ on 17 June, in Johnston County, North Carolina.

Death of Robert Larry Franks²⁶⁷ on 29 July, in Wake County, Wendell, North Carolina.

Death of Robert Sidney Perry³⁴² on 14 September, in Wake County, North Carolina.

Birth of Franklin Taylor Dupree Jr.²⁵⁷ on 8 October.

1914

Birth of Clara Emily Dupree [Denning]²²⁸ on 25 February.

Marriage of William Nathaniel "Nat" Franks³¹² and Martha Franks [Mitchell]³¹⁴.

Birth of Leah Elizabeth Woodall [Alley]²⁵⁰ on 9 October.

1915

Death of Willis L. Woodall²⁷⁰ on 25 July.

1917

Death of Eugenia "Jane" Dupree [Stancil]³²⁰ on 18 October.

1918

Birth of James Clayborn Butts¹¹² on 7 June.

Death of Emma Gasten Franks [Jones]³⁴¹ on 9 August.

1919

Birth of Herman Keck Dupree²⁵⁸ on 4 February.

Death of John Henry Quinn⁶³⁶ on 25 November.

1920

Birth of William Nathan "Mutt" Carroll¹⁷⁴ on 27 March.

1921

Death of William "Anguish" Dupree²⁹⁸ on 24 May.

Birth of Annie Lee Shepard [Franks]²⁴⁵ on 25 May.

Birth of Luther Warren Franks²⁴³ on 29 May.

1922

Birth of James "Wilburn" Dupree¹⁴⁶ on 15 May.

Birth of Bill Ulysses Davis¹¹⁴ on 28 June, in Johnston County, North Carolina.

Marriage of Gilbert Chesley Woodall¹⁹⁶ and Alda Leland Woodall [Britt]¹⁹⁷ on 6 December.

1923

Birth of Cecil Adair Fuquay¹⁴⁰ on 9 September.

1924

Birth of Doris Britt Butts [Woodall]¹¹¹ on 24 January.

Birth of Eira Watkins [Taylor]²³⁶ on 21 March, in Harnett County, North Carolina.

1924 (Continued)

Marriage of "Graham" Hubbard Franks²⁴¹ and Bettie Allene Franks [Barbour]²⁴² on 24 April.
 Death of John Benton Dupree³²¹.
 Birth of Kathleen Franks [Humphries]²⁴⁴ on 16 October.
 Birth of Harry Clay Dupree²⁵⁹ on 4 November.

1925

Marriage of Silas Greene Adams²²² and Ila Ann Adams [Dupree]²²¹ on 9 May.
 Birth of Frances Loraine Davis [Woodall]¹¹³ on 12 July.
 Birth of Blanche William Dupree [Ogburn]²⁶⁰ on 30 November.
 Marriage of Fred Edward Dean²⁰³ and Bettie Vandon Dean [Woodall]²⁰² on 21 December.

1926

Birth of Betty "Josephine" Carroll [Franks]¹⁷³ on 3 February.
 Marriage of Hunter McGuire Woodall²⁰⁰ and Fannie Lee Woodall [Goldston]²⁰¹ on 3 April.
 Birth of CPL Kenneth Lee Watkins²²⁹ on 5 August.
 Death of Caroline F Durham⁶³³ on 18 November, in Garner, North Carolina.

1927

Birth of Davis Bryant Woodall¹⁰⁹ on 7 January.
 Birth of Susan Evelyn O'Neal [Dupree]¹⁴⁸ on 31 March.
 Birth of Nancy Adeline Dupree [Dilday]¹⁸⁶ on 22 September.
 Death of Mary Francis Britt [Guy]²⁶⁴ on 3 November.
 Marriage of Ottis Alden Dupree²¹⁷ and Myrtle Irene Dupree [Stephenson]²¹⁸ on 24 December.

1928

Birth of Etholea Dupree [Hardee]¹⁴⁷ on 15 February.
 Birth of Raythell Greene Adams¹⁵³ on 17 February.
 Birth of Annie Duke Dean [Wheless]¹²⁵.
 Birth of Edward Woodall Dean¹²⁴.
 Birth of Daniel Parker "Danny" Watkins²³² on 3 September.
 Birth of Martha Rebecca Creech¹⁵⁷ on 9 September.
 Birth of John Elmond "J.E." Dupree Jr.¹⁸⁵ on 19 September.
 Birth of Virginia Grace Watkins [Matthews]²³⁰ on 4 December.
 Death of Ruby Mable Beck [Franks]²⁸⁸ on 7 December.
 Marriage of John Stuart Dupree¹⁹⁸ and Ruby Larry Dupree [Franks]¹⁹⁹ on 15 December.
 Birth of William Anguish "W.A." Dupree Jr.¹⁸⁷ on 26 December.

1929

Birth of Joanna Catherine Dupree [Pttard]¹⁸⁸ on 14 March.
 Death of Emma Foy Hayes [Franks]²⁸⁶ on 19 April, in Robeson County, Marietta, North Carolina.
 Birth of William Marshburn "Bill" Watkins²³⁵ on 29 May.
 Death of William Nathaniel "Nat" Franks³¹² on 1 July.
 Birth of Stacy Lee Dupree¹³⁷ on 22 July.
 Birth of Patsy Ennis O'Neal [Dupree]¹⁴⁹ on 29 July.
 Birth of Betty Lou Dean¹²⁶ on 4 October.

1930

Birth of Edward Hale Woodall II¹²⁷ on 3 March.
 Birth of Charles Larry Dupree¹¹⁵ on 27 March.
 Birth of Hunter McGuire Woodall Jr.¹²² on 14 June.
 Death of Alda Leland Woodall [Britt]¹⁹⁷ on 12 July.
 Birth of Claude Leroy Baker²⁴⁸ on 20 July.
 Death of Charlie Benton Dupree²⁶⁵ on 28 August.
 Birth of Doris Pearl Dupree [Wilkerson]¹³⁸ on 22 September.
 Birth of Emily Adams [Blanchard]¹⁵⁴ on 29 September.

1931

Birth of Charles R "Chuck" Pumroy⁶²¹ on 6 May.
 Birth of Ruth Emma Baker [Franks]²⁴⁷.
 Birth of Carolyn Watkins [Johnson]²³³ on 24 November.

1932

Birth of Sarah Francis Woodall¹²³ on 1 January.
 Birth of Betty Sue Woodall [Dupree]¹¹⁰ on 21 February.
 Birth of Roy Neal Moore Jr.⁶¹⁵ on 1 March.
 Birth of Joseph Gerald "Butch" Adams¹⁵⁵ on 4 March.

1932 (Continued)

Birth of Martha Stella Woodall¹²⁸ on 24 August.
 Birth of Thomas Layton Dupree¹⁵¹ on 11 September.
 Birth of Edna Pumroy [Wilson]⁶²⁰ on 25 October.

1933

Death of Susan Alice Marshburn [Parker]³¹⁶ on 6 January.
 Birth of Billie Jean Dupree [Stephenson]¹¹⁶ on 19 October.

1934

Death of Martha Stella Woodall¹²⁸ on 24 January.
 Death of Dr Berry Daniel Marshburn³¹⁵ on 30 March.
 Birth of Shirley Ann Fuquay [Dupree]¹³⁹ on 22 May.
 Death of Edward Hale Woodall II¹²⁷ on 9 June.
 Birth of Herman Dennis O'Neal¹⁵⁰ on 5 November.

1935

Birth of John Royster Dupree¹¹⁷ on 6 February.
 Birth of Betty Jean "BJ" Moore [Wilson]⁶¹⁶ on 15 April, in At home in Magnolia, NC.

1936

Birth of Nancy Carol Moore [Washington]⁶¹⁹ on 26 May.
 Birth of Charles Allen Moore⁶¹⁸ on 9 July, in Raleigh, North Carolina.
 Birth of Carolyn Muriel Bradley¹³² on 7 November.

1937

Birth of Shirley Faye Watkins [Wilkerson]²³¹ on 10 March.
 Birth of Mary Lynn Dupree [Smith]¹⁵² on 25 April.
 Death of Edward Hale Woodall²⁶¹ on 11 November.

1938

Birth of Edward Marshall Woodall¹²⁹ on 4 February.
 Birth of Jean Caroline Lee [Adams]¹⁵⁶ on 28 February.

1939

Death of William Adderson Watkins²⁶⁹ on 5 February.
 Birth of Lora Ann Moore [Gray]⁶¹⁷ on 19 May, in Littleton, North Carolina.
 Death of William Wells Wilson⁶²⁷ on 26 May.
 Birth of Rex Kenneth Bradley Jr.¹³³ on 19 June.
 Birth of Bobby Willis Young⁹⁰ on 28 August.
 Birth of William Edward "Billy" Wilson Sr.⁶²² on 2 September.

1940

Death of Lugenia Elizabeth "Bettie" Dupree [Smith]²⁹⁹ on 8 June.
 Death of Zeba Bunyan Britt²⁷⁷.

1941

Death of Benjamine Franklin Dupree³²⁶ on 2 May.
 Birth of Elizabeth Ellen "Beth" Woodall¹⁸⁰ on 17 August.

1942

Birth of Joan Wilson [Brown]⁶²³ on 24 June.
 Birth of James Lynwood Dupree¹¹⁸ on 30 June.
 Birth of Evelyn Bradley [Pleasant]¹³⁴.
 Birth of Harold Bert Woodall¹³⁰ on 20 November.
 Birth of Donnie Ray Dupree¹⁴¹ on 30 December.

1943

Birth of Dewitt Creech "Woody" Woodall Jr.¹⁸¹ on 14 March.
 Birth of Betty Carolyn Dupree [Radford]¹⁴⁴.

1944

Birth of Donna Kay Gaskin [Dupree]¹⁸⁹.
 Birth of Rachael Jane Dupree [Honeycutt]¹²⁰ on 14 August.
 Birth of Jerry Mac Bradley¹³⁵ on 25 November.

1945

Birth of James Lenn Butts⁵⁵ on 9 February.
 Birth of Ronald Holton Dupree¹⁹⁰ on 17 May.
 Birth of "Donald" Ray Franks¹⁷⁵ on 27 June.
 Death of Sarah Woodall [Lee]²⁶².
 Death of Martha Caroline Dupree [Young]²⁶⁶ on 29 August.

1945 (Continued)

Birth of Frank Alley "Al" Woodall¹⁸³ on 7 December, in Harnett County, North Carolina.

1946

Birth of Larue Dupree [Williford]¹¹⁹ on 15 February.

Birth of Gayle Franks [Hardy]¹⁷⁷.

Birth of Johnnie Loteze Chambers⁵⁸.

Marriage of William Nathan "Mutt" Carroll¹⁷⁴ and Betty "Josephine" Carroll [Franks]¹⁷³ on 9 August.

Birth of Michael Franks¹⁷⁶ on 22 October.

Birth of Robert Britt Davis⁵⁹ on 17 December.

1947

Birth of William Taylor "Billy" Watkins¹⁷⁰ on 23 January.

Birth of Johnny Lee Watkins¹⁵⁹ on 30 March.

Birth of Mary Woodall [Olive]¹⁸².

Birth of Johnny Lee Dupree¹⁹¹.

Birth of Larry David Rowe⁷⁹.

Birth of Linda Carol Dupree [Glasgow]¹⁴³.

1948

Birth of Ronald Williard "Buddy" Davis⁶¹ on 22 January.

Birth of Leland Diane Chambers [Butts]⁵⁷ on 2 March.

Marriage of Harry Clay Dupree²⁵⁹ and Blanche William Dupree [Ogburn]²⁶⁰ on 11 September.

Marriage of James "Wilburn" Dupree¹⁴⁶ and Etholea Dupree [Hardee]¹⁴⁷ on 13 November.

1949

Death of Clida Lee Woodall²⁰⁴ on 7 March.

Birth of Janet Lynn White [Dupree]¹⁹³.

Death of Leigh Edward Woodall²⁰⁵ on 14 July.

1950

Birth of Stuart Randall "Randy" Dupree¹²¹ on 25 June.

Birth of Roger Wayne Maye⁸⁸.

Birth of Betty Grace Barnes [Watkins]¹⁶¹ on 22 July.

Death of Rachel Stroud Quinn⁶³⁷ on 18 October.

1951

Birth of Joan Elizabeth Blalock [Dupree]¹⁹⁴ on 11 January.

Birth of Ellie Leigh "Bunny" Dupree [Wood]⁸¹ on 15 January.

Death of Silas Greene Adams²²² on 24 March.

Marriage of Stacy Lee Dupree¹³⁷ and Doris Pearl Dupree [Wilkerson]¹³⁸ on 31 March.

Birth of Susan "Elaine" Price [Dupree]⁸⁷ on 31 March.

Marriage of Edward Woodall Dean¹²⁴ and Annie Duke Dean [Wheless]¹²⁵ on 17 June, in Franklin, North Carolina.

Birth of Joseph Edgar Capps⁵⁴ on 30 July.

Birth of Janet Doane Adams [Dupree]¹⁹² on 29 December.

1952

Death of Joseph Burke Britt²⁸⁰ on 2 March.

Birth of Deborah Lynn Hill [Dupree]¹⁰⁵.

Birth of Frankie Wayne "Red Bug" Carroll¹⁰⁰ on 23 July.

Birth of Kathy Lynn Rowe [Dupree]⁷⁸ on 14 September.

Marriage of Davis Bryant Woodall¹⁰⁹ and Betty Sue Woodall [Dupree]¹¹⁰ on 3 October.

1953

Birth of Daniel Parker "Danny" Watkins Jr.¹⁶⁷ on 7 May.

Birth of Robert Lynn "Bobby" Sheets⁶⁶¹.

Birth of Jane Bradley [S]¹³⁶.

Birth of Davis Bryant "Dave" Woodall Jr.⁵¹ on 12 July, in Rex Hospital, Raleigh, North Carolina.

1954

Birth of Shirley Dupree [Murphy]¹⁴⁵ on 18 June.

Birth of Elizabeth Dupree¹⁰⁶.

Birth of Jonathan Lemoyne Rose⁶⁷³ on 29 July.

Birth of Bonnie Lou Poole [Watkins]¹⁶³ on 24 September.

Birth of Linda Kay Capps [Woodall]⁵³ on 3 December.

1955

Birth of Joseph Ronald "Ronnie" Adams⁹⁷ on 9 January.

Birth of Beverly Clay Davis [Dupree]¹⁹⁵ on 8 March.

1955 (Continued)

Birth of Gregory Wayne Pumroy⁶⁰⁶ on 30 April.
 Birth of Ruth Petrea [Dupree]¹⁰⁷.
 Birth of Daley Glenn Dupree¹⁵⁸ on 23 September.
 Birth of Larry Glenn Dupree⁸² on 2 December.
 Birth of Gary Ken Dupree⁸⁰ on 2 December.

1956

Birth of Mark Lee Price⁸⁹ on 13 April.
 Death of Fannie Telfer Dupree [Love]³²⁷ on 31 August.
 Birth of Timothy Marshburn "Timmy" Watkins¹⁷¹ on 26 September.

1957

Birth of Janet Lynne Franks [Swiger]¹⁷⁸ on 21 March.
 Birth of Claudia Ruth Baker¹⁷⁹.
 Birth of William A Dupree III¹⁰⁸.
 Marriage of Herman Dennis O'Neal¹⁵⁰ and Patsy Ennis O'Neal [Dupree]¹⁴⁹ on 12 July.
 Death of Cecil Ripton Wilson⁶³⁴ on 18 July.

1958

Marriage of Roy Neal Moore Jr.⁶¹⁵ and Betty Jean "BJ" Moore [Wilson]⁶¹⁶ on 6 June, in Ernest Myatt Presbyterian Church, Raleigh, North Carolina.
 Death of Broughton C Britt²¹⁵ on 20 June.
 Birth of Victor D Goffredo⁶⁰⁸.
 Birth of Angela Goffredo [Pumroy]⁶⁰⁷.
 Death of Willis Lester Woodall²⁰⁹ on 19 September.
 Death of Samuel "Lattie" Franks²⁸² on 18 December, in Wake County, North Carolina.

1959

Death of Rebecca Mathis Wilson⁶³⁵ on 9 May.
 Birth of Roy Neal Moore III⁵⁹⁹ on 21 May.
 Birth of Richard A Mellor⁶¹⁰.
 Death of Mamie Ethel Moore [Durham]⁶²⁶ on 7 July.
 Death of Leonard Lethco Britt²⁶³ on 6 August.
 Birth of Dennis Alan O'Neal⁹¹ on 1 September.
 Death of Mildred Dupree [Jones]²²⁴ on 11 December, in Angier, North Carolina.

1960

Birth of Susan Matthew Thompson [Watkins]¹⁶⁵ on 29 March.
 Birth of Steve H Fowler⁶⁵⁵ on 13 May.
 Birth of Lisa Ann Fuquay⁸⁴ on 13 May.
 Death of Lalah Florence Dupree [Gardner]³⁰¹.
 Birth of Barry R Francescangeli⁶⁰⁹.
 Birth of Deborah Joanne Moore [Cratch]⁶⁰⁰ on 31 July.
 Marriage of Charles Allen Moore⁶¹⁸ and Nancy Carol Moore [Washington]⁶¹⁹ on 4 September.
 Birth of Sharon Moore [Mitchell]⁶⁰¹ on 18 September.
 Birth of Terry Lee O'Neal⁹² on 12 December.

1961

Birth of Ronnie Lynn Poole¹⁶⁴ on 26 February.
 Birth of William Edward "Billy" Wilson Jr.⁶¹¹.
 Birth of Larry Gene Dupree⁶² on 21 July.
 Marriage of Donnie Ray Dupree¹⁴¹ and Mamie Lou Dupree [Johnson]¹⁴² on 23 November.

1962

Birth of Michael Allen Moore⁶⁰² on 9 May.
 Birth of Melody Jean Dupree [Page]⁸³ on 4 June.
 Birth of Tammy Richelle Ferebee [Dupree]⁹⁴ on 5 October.

1963

Death of Grover Carr Franks²⁸⁷ on 3 February, in Wake County, North Carolina.
 Birth of Rebecca Sue "Becky" Eason [Dupree]⁶³ on 20 May.
 Birth of Karen Denise Woodall [Moore]⁵² on 10 June, in Rex Hospital, Raleigh, North Carolina.
 Death of Charles Glenn Dupree²²⁷ on 8 August.
 Death of John Franklin Woodall²⁹⁶ on 2 September.

1964

Death of Barry Sherman Dupree⁹⁵ on 29 October.

1964 (Continued)

Birth of Barry Sherman Dupree⁹⁵ on 29 October.
 Death of William Taylor "Billy" Watkins¹⁷⁰ on 13 November, in Dunn, NC.
 Death of Vienna Jannetta Franks [Marshburn]²⁶⁸ on 20 December.

1965

Death of Bettie Perry Franks [Spears]²⁸³ on 28 February.
 Birth of William Martin "Marty" Moore⁶⁰³ on 30 May.
 Death of Billie Jean Dupree [Stephenson]¹¹⁶ on 22 June.
 Marriage of Donnie Ray Dupree¹⁴¹ and Linda Carol Dupree [Glasgow]¹⁴³ on 2 October.

1966

Birth of Lisa M Dolan [Franks]¹⁰³.
 Death of Henry Quinton Dupree³⁰⁰.
 Death of Stuart Randall "Randy" Dupree¹²¹ on 23 November.
 Death of Ida Jones [Watkins]²³⁷ on 12 December.

1967

Death of Lewis Nathaniel "Snooks" Franks²⁸⁹ on 29 May.
 Birth of Mark Andrew O'Neal⁹³.
 Death of Alvis Holton Dupree²⁵⁵.
 Birth of Kevin Ray Dupree⁸⁵ on 26 July.
 Birth of Laura Lynn Honeycutt [Dupree]⁶⁵ on 4 October.

1968

Death of William Anguish Dupree Sr.²⁵³ on 17 February.
 Death of Lee Perry Franks²⁹² on 31 August, in Raleigh, North Carolina.
 Birth of Frances Wilson [Hawes]⁶¹² on 22 October.
 Death of Franklin Tell Dupree³⁰² on 15 November.

1969

Marriage of CPL Kenneth Lee Watkins²²⁹ and Shirley Faye Watkins [Wilkerson]²³¹ on 22 February.
 Death of Dorsey Benard Dupree²¹⁹ on 22 April.
 Birth of Chad David Thomas⁴⁶.
 Birth of Robin Jackson [Bradley]⁷¹.
 Death of Charles Larry Dupree¹¹⁵ on 21 September.
 Death of Leddie Bain Franks²⁸⁴ on 18 October.
 Marriage of Roger Wayne Maye⁸⁸ and Susan "Elaine" Price [Dupree]⁸⁷ on 20 December.

1970

Birth of Patrick "Brian" Wilson⁶¹³ on 29 March.
 Birth of Scott P Franks¹⁰⁴.
 Death of Myrtle Irene Dupree [Stephenson]²¹⁸.
 Birth of Susan "Kelly" Thomas [Young]⁴⁵.
 Death of John Elmond Dupree Sr.²⁵¹ on 30 September.
 Birth of Kari Dupree⁸⁶ on 13 October.

1971

Death of Ila Ann Adams [Dupree]²²¹ on 4 April.
 Death of Ottis Alden Dupree²¹⁷ on 4 August, in Harnett County, North Carolina.
 Marriage of Johnnie Loteze Chambers⁵⁸ and Leland Diane Chambers [Butts]⁵⁷ on 19 August.
 Death of CPL Kenneth Lee Watkins²²⁹ on 18 November.

1972

Marriage of Donnie Ray Dupree¹⁴¹ and Betty Carolyn Dupree [Radford]¹⁴⁴.
 Birth of Joseph Francis "Joey" Brennan Jr.⁶⁵⁷.
 Death of Lance H. Franks²⁹³ on 5 July, in Caldwell County, Lenoir, North Carolina.

1973

Birth of Kerry Lyn Beaver [Bradley]⁷³.
 Death of Daley Glenn Dupree¹⁵⁸ on 13 August.

1974

Marriage of Joseph Edgar Capps⁵⁴ and Linda Kay Capps [Woodall]⁵³ on 29 June.
 Birth of Allison Leslie Stephenson [Young]⁴⁷.

1975

Birth of Heather Dawn Marler [Dupree]⁹⁶ on 18 February.
 Death of Timothy Marshburn "Timmy" Watkins¹⁷¹ on 26 April.
 Birth of Tracy Alan Stephenson⁴⁸.

1975 (Continued)

Death of Dewitt Creech Woodall²⁴⁹ on 2 September.

1976

Death of John Stuart Dupree¹⁹⁸ on 23 July, in Raleigh, North Carolina.

Death of Elizabeth "Lizzie" Dupree [Wells]³⁰³ on 17 August.

1977

Birth of Amber Wilson [Powell]⁶¹⁴ on 10 June.

1978

Death of Fannie Lee Woodall [Goldston]²⁰¹ in March.

Birth of Harry Lee Smith Jr.²⁵ on 31 March.

Death of Effie Ray Wilson [Quinn]⁶²⁸ on 30 August.

Death of Gilbert Chesley Woodall¹⁹⁶ on 24 December, in Veterans Hospital Fayetteville, North Carolina.

Death of Mallie Dupree [Ennis]²²⁰ on 27 December.

1979

Death of Ila Britt²¹³ on 10 May.

Death of Fred Edward Dean²⁰³ in June.

Birth of Joseph Edgar Capps Jr.²² on 14 November.

1980

Birth of Kristen Capps [Kidwell]²³ on 25 March.

Death of Clara Emily Dupree [Denning]²²⁸ on 1 April, in Good Hope Hospital Erwin, North Carolina.

Death of Rado Utah Ennis [Britt]²¹⁴ on 12 April.

Birth of Rachel Tiffany Mellor⁵⁹⁴.

Birth of Clare Melissa Bradley⁷⁵.

1981

Death of Hunter McGuire Woodall²⁰⁰ on 18 April.

Death of Cary Melvin Dupree²²³ on 16 May.

Death of Stacy Lee Dupree¹³⁷.

Birth of Rex Bradley⁷⁶.

Death of Bert Albert Woodall²⁰⁷ on 26 July.

Marriage of Dewitt Creech "Woody" Woodall Jr.¹⁸¹ and Mary Woodall [Olive]¹⁸² on 14 November.

Birth of Jennifer Lynn Smith [Capps]²⁴ on 21 December.

1982

Death of Larry Gene Dupree⁶² on 16 March.

1983

Death of George Halford Barbour⁶⁶⁸ on 2 January.

Marriage of Mark Lee Price⁸⁹ and Susan "Elaine" Price [Dupree]⁸⁷ on 29 January.

Death of William Nathan "Mutt" Carroll¹⁷⁴ on 20 March.

Death of "Graham" Hubbard Franks²⁴¹ on 14 May.

Death of Graham Dennis Shepard²⁴⁶ on 1 July.

1984

Birth of Brandon Lee Price⁴⁴ on 13 January.

Birth of Asley Swiger Jarvis [Rose]⁶⁷².

Death of Christopher Clinton Franks²⁹⁴ on 19 August, in Raleigh, North Carolina.

1985

Marriage of Larry Glenn Dupree⁸² and Melody Jean Dupree [Page]⁸³ on 26 January.

Death of Clyda Dupree [Young]²⁵⁶.

Birth of Adam Bryant Capps²⁶ on 24 November.

1986

Birth of Kenneth Marvin Watkins⁹⁸ on 10 April, in Besty Johnson Memorial Hospital, Dunn, North Carolina.

Birth of Jessica Capps [Wood]²⁷ on 3 July.

Death of Annie Sexton [Britt]²¹² on 6 July.

Death of James Clayborn Butts¹¹² on 6 October.

1987

Marriage of Donnie Ray Dupree¹⁴¹ and Shirley Dupree [Murphy]¹⁴⁵ on 21 February.

Birth of Matthew Shane Poole⁹⁹ on 7 April, in Besty Johnson Memorial Hospital, Dunn, North Carolina.

Marriage of Davis Bryant "Dave" Woodall Jr.⁵¹ and Karen Denise Woodall [Moore]⁵² on 12 December, in Ernest Myatt Presbyterian Church, Raleigh, North Carolina.

Death of Roy Neal Moore⁶²⁵ on 24 December.

1988

Birth of Nicole Johnson [Fowler]⁶⁵³ on 13 January.

1988 (Continued)

Death of Mattie Dupree [Brickhouse]²⁵² on 25 May.
 Birth of Michael Johnson⁶⁵⁴ on 15 June.
 Birth of Leeann M Bradley⁷⁷.

1989

Marriage of Roy Neal Moore III⁵⁹⁹ and Deborah Joanne Moore [Cratch]⁶⁰⁰ on 19 August, in Pleasant Grove Baptist Church, Fuquay Varina, North Carolina.
 Death of Lillian "Lillie" Mary Franks [Godwin]²⁸⁵ on 21 October.

1990

Birth of Ryan Neal Moore⁵⁹⁰ on 23 February.
 Birth of Bryant Lee Woodall¹⁷ on 4 May, in Wake Medical Center, Raleigh, North Carolina.
 Marriage of Gary Ken Dupree⁸⁰ and Ellie Leigh "Bunny" Dupree [Wood]⁸¹ on 18 August.
 Marriage of James Lynwood Dupree¹¹⁸ and Rachael Jane Dupree [Honeycutt]¹²⁰ on 14 December.

1991

Death of Herman Keck Dupree²⁵⁸ in Yellowstone Co, Montana.

1992

Death of Shirley Ann Fuquay [Dupree]¹³⁹ on 26 April.
 Birth of Cody Davis Woodall¹⁹ on 6 August, in Wake Medical Center, Raleigh, North Carolina.
 Marriage of Chad David Thomas⁴⁶ and Susan "Kelly" Thomas [Young]⁴⁵ on 22 August.
 Death of John Elmond "J.E." Dupree Jr.¹⁸⁵ on 9 September.
 Death of Martha Rebecca Creech¹⁵⁷ on 29 November.

1993

Death of Luther Warren Franks²⁴³ on 27 May.
 Death of Hunter McGuire Woodall Jr.¹²² on 23 September.
 Death of Alpha Byon Franks²⁹⁵ on 6 October, in Wake County, North Carolina.

1994

Death of Candice Mozelle Woodall [Fish]²⁰⁸ on 27 January.
 Birth of Shannen Jean Moore⁵⁹² on 13 May.
 Birth of Christine Denise Woodall [Wilder]²⁰ on 17 July.
 Birth of Jesse Marie Woodall [Morgan]¹⁸ on 29 October.
 Death of Doris Pearl Dupree [Wilkerson]¹³⁸ on 21 December.

1995

Birth of Christian "Tanner" Brennan⁶⁵⁶.
 Birth of Taylor Francescangeli⁵⁹³.
 Marriage of Michael Wallace Honeycutt⁶⁶ and Laura Lynn Honeycutt [Dupree]⁶⁵ on 9 December.
 Death of Franklin Taylor Dupree Jr.²⁵⁷ on 17 December.
 Birth of William Edward "Will" Wilson III⁵⁹⁵ on 18 December.

1997

Birth of Chase Hunter Woodall²¹ on 11 February, in Raleigh Community (now Duke), Raleigh, North Carolina.
 Birth of Cade Wallace Honeycutt³⁸ on 12 May.
 Death of Bettie Vandon Dean [Woodall]²⁰² on 18 May.
 Birth of Hannah Elizabeth Honeycutt [Overby]³⁹.
 Death of Joseph Gerald "Butch" Adams¹⁵⁵ on 13 September.
 Death of Joan Wilson [Brown]⁶²³ on 12 December.

1998

Death of James "Wilburn" Dupree¹⁴⁶ on 17 February.
 Death of Joanna Catherine Dupree [Pttard]¹⁸⁸ on 14 April.
 Marriage of Tracy Alan Stephenson⁴⁸ and Allison Leslie Stephenson [Young]⁴⁷ on 16 May.

1999

Death of William Anguish "W.A." Dupree Jr.¹⁸⁷ on 16 January, in Montlawn Memorial Park, Raleigh, Wake Co, NC.
 Death of Betty "Josephine" Carroll [Franks]¹⁷³ on 31 March.
 Death of Carolyn Watkins [Johnson]²³³ on 4 June.
 Death of Lydia Franks [Massey]²⁹⁰.
 Birth of Caleb Smith⁸ on 15 July.
 Death of Bettie Allene Franks [Barbour]²⁴² on 5 October.

2000

Death of Steve H Fowler⁶⁵⁵ on 6 March.
 Death of Rex Kenneth Bradley²¹¹ on 7 September.
 Death of Shirley Faye Watkins [Wilkerson]²³¹ on 16 October.

- 2001**
 Death of Claude Leroy Baker²⁴⁸ on 16 April.
 Death of Betty Sue Woodall [Dupree]¹¹⁰ on 22 December, in Good Hope Hospital Erwin, North Carolina.
- 2003**
 Death of Deborah Joanne Moore [Cratch]⁶⁰⁰ on 19 February.
 Marriage of Roy Neal Moore III⁵⁹⁹ and Sharon Moore [Mitchell]⁶⁰¹ on 5 April.
 Death of Ronald Williard "Buddy" Davis⁶¹ on 28 June.
 Marriage of Patrick "Brian" Wilson⁶¹³ and Amber Wilson [Powell]⁶¹⁴ on 4 July.
 Death of Mary Lynn Dupree [Smith]¹⁵² on 5 October.
- 2004**
 Death of Patsy Ennis O'Neal [Dupree]¹⁴⁹ on 27 January.
 Death of William Marshburn "Bill" Watkins²³⁵ on 29 February.
 Death of Harry Clay Dupree²⁵⁹ on 18 June, in Besty Johnson Memorial Hospital, Dunn, North Carolina.
 Death of Ruby Larry Dupree [Franks]¹⁹⁹ on 16 September, in Britthaven in Dunn, North Carolina.
- 2005**
 Death of Evelyn Bradley [Pleasant]¹³⁴ on 4 February.
 Death of Leah Elizabeth Woodall [Alley]²⁵⁰ on 12 July.
 Birth of Addison Bailey Capps¹⁰ on 30 September.
 Death of Jonathan Lemoyne Rose⁶⁷³ on 19 October.
- 2006**
 Death of Ruth Naola Dupree²⁵⁴ on 2 March.
 Death of Etholea Dupree [Hardee]¹⁴⁷ on 9 June.
 Marriage of Daniel Parker "Danny" Watkins²³² and Barbara Jean Watkins [Davis]²³⁴ on 31 July.
- 2007**
 Death of William Edward "Billy" Wilson Sr.⁶²² on 6 December, in Kitty Askins Hospice Center in Goldsboro, NC.
- 2008**
 Death of Johnnie Loteze Chambers⁵⁸ on 22 June.
 Death of Gregory Wayne Pumroy⁶⁰⁶ on 23 June.
 Death of Sallie Muriel Bradley [Woodall]²¹⁰ on 28 August.
- 2009**
 Death of Doris Britt Butts [Woodall]¹¹¹ on 17 March, in E. Carlton Powell Hospice Center, Lillington, North Carolina.
 Birth of Tovi Piper Capps⁵ on 23 September, in Wake Medical Center, Cary, North Carolina.
- 2010**
 Death of Bobby Willis Young⁹⁰ on 3 April.
 Death of Raythell Greene Adams¹⁵³ on 27 September.
 Death of Brandon Lee Price⁴⁴ on 30 October.
- 2011**
 Birth of Brody Matthew Moore⁵⁸⁹ on 30 January.
 Death of Daniel Parker "Danny" Watkins²³² on 20 July.
- 2012**
 Death of Blanche William Dupree [Ogburn]²⁶⁰ on 24 March.
 Marriage of Michael Johnson⁶⁵⁴ and Nicole Johnson [Fowler]⁶⁵³ on 14 April.
- 2013**
 Death of Frances Loraine Davis [Woodall]¹¹³ on 17 January.
 Death of Rex Kenneth Bradley Jr.¹³³ on 21 April.
 Death of Charles R "Chuck" Pumroy⁶²¹ on 24 April.
 Marriage of Harry Lee Smith Jr.²⁵ and Jennifer Lynn Smith [Capps]²⁴ on 21 June, in Edenton Street United Methodist Church Raleigh, North Carolina.
 Death of Cecil Adair Fuquay¹⁴⁰ on 23 August.
 Death of Annie Lee Shepard [Franks]²⁴⁵ on 4 November.
 Death of John Royster Dupree¹¹⁷ on 16 November, in Summerton, South Carolina.
 Birth of Cooper Steven Johnson⁶⁵¹ on 21 December.
- 2014**
 Death of Susan Evelyn O'Neal [Dupree]¹⁴⁸ on 9 September.
 Death of Frankie Wayne "Red Bug" Carroll¹⁰⁰ on 24 October.
- 2015**
 Death of Davis Bryant Woodall¹⁰⁹ on 21 January, in Oak Hill Living Center, Angier, North Carolina.
 Death of Harold Bert Woodall¹³⁰ on 14 December.
- 2016**
 Death of Emily Adams [Blanchard]¹⁵⁴ on 18 April, in Angier, North Carolina.

2016 (Continued)

Death of Lora Ann Moore [Gray]⁶¹⁷ on 10 May.

Marriage of Cody Davis Woodall¹⁹ and Christine Denise Woodall [Wilder]²⁰ on 15 May, in Market Hall Raleigh, North Carolina.

Birth of Cassidy Nicole Johnson⁶⁵² on 26 June.

Death of Joseph Ronald "Ronnie" Adams⁹⁷ on 24 December.

2017

Death of Charles Allen Moore⁶¹⁸ on 15 March, in Carteret Health Care Morehead City, North Carolina.

Death of Bonnie Lou Poole [Watkins]¹⁶³ on 25 March, in At sons home.

Death of Nancy Adeline Dupree [Dilday]¹⁸⁶ on 3 July.

2018

Death of Susan "Elaine" Price [Dupree]⁸⁷ on 14 February.

Death of Bill Ulysses Davis¹¹⁴ on 28 February, in SECU Hospice House, Smithfield, NC.

Death of Eira Watkins [Taylor]²³⁶ on 31 July.

Death of Virginia Grace Watkins [Matthews]²³⁰ on 12 December, in Harnett Woods Nursing Home Dunn, NC.

2019

Death of Betty Jean "BJ" Moore [Wilson]⁶¹⁶ on 24 February, in At home in Raleigh, NC.

Death of Donnie Ray Dupree¹⁴¹ on 18 March.

Marriage of Bryant Lee Woodall¹⁷ and Jesse Marie Woodall [Morgan]¹⁸ on 12 October, in Gregory Vineyards, Angier, NC.

2020

Birth of Peyton James Woodall³ on 14 November, in UNC Rex Hospital, Raleigh, North Carolina.

Death of Rachael Jane Dupree [Honeycutt]¹²⁰ on 6 December, in Home.

Birth of Palmer Grace Honeycutt¹² on 7 December.

2021

Birth of Wyatt Lee Woodall² on 16 February, in UNC Health Johnson, Clayton, NC.

Birth of Walker Samuel Woodall¹ on 16 February, in UNC Health Johnson, Clayton, NC.

Birth of Easton Neal Moore⁵⁸⁸ on 21 July.

Death of Nancy Carol Moore [Washington]⁶¹⁹ on 8 October, in Carteret Health Care, Morehead City, NC.

Birth of Carter Davis Woodall⁴ on 11 December, in UNC Rex Hospital, Raleigh, North Carolina.

2022

Marriage of Cade Wallace Honeycutt³⁸ and Hannah Elizabeth Honeycutt [Overby]³⁹ on 28 October, in Mount Pleasant, South Carolina.

2023

Death of Roy Neal Moore Jr.⁶¹⁵ on 11 March, in Roy Neal Moore III home in Wake County NC.

18. INDEX OF INDIVIDUALS

<u>Ref.</u>	<u>Tree</u>	<u>Name (Relationship)</u>
154		ADAMS [BLANCHARD], Emily (Davis' cousin's wife, once removed).
221	9	ADAMS [DUPREE], Ila Ann (Davis' great-aunt).
192	 Janet Doane (Davis' fourth cousin, once removed).
361	14	ADAMS [GREEN], Delilah (Davis' four-times-great-grandmother).
339	14	ADAMS [JOHNSON], Talitha (Davis' great-great-great-grandmother).
360	14	ADAMS, John (Davis' four-times-great-grandfather).
338	14 Joseph (Davis' great-great-great-grandfather).
155	 Joseph Gerald "Butch" (Davis' cousin, once removed).
97	 Joseph Ronald "Ronnie" (Davis' second cousin).
153	 Raythell Greene (Davis' cousin, once removed).
222	 Silas Greene (Davis' great-uncle by marriage).
168		ADCOCK [WATKINS], Debbie (Davis' cousin, once removed).
247		BAKER [FRANKS], Ruth Emma (Davis' cousin, twice removed).
248		BAKER, Claude Leroy (Davis' cousin's husband, twice removed).
179	 Claudia Ruth (Davis' second cousin, once removed).
668		BARBOUR, George Halford (Rachael Jane Dupree [Honeycutt]'s husband).
666	 Kevin (Rachael Jane Dupree [Honeycutt]'s son).
664	 Scott (Rachael Jane Dupree [Honeycutt]'s son).
665	 Shea (Rachael Jane Dupree [Honeycutt]'s daughter-in-law).
667	 Tracie (Rachael Jane Dupree [Honeycutt]'s daughter-in-law).
161		BARNES [WATKINS], Betty Grace (Davis' cousin, once removed).
162		BARNES, David (Davis' cousin's husband, once removed).
50		BARWICK [CARROLL], Jamie (Davis' third cousin, once removed).
102		BEASLEY [CARROLL], Brenda (Davis' third cousin).
73		BEAVER [BRADLEY], Kerry Lyn (Davis' second cousin).
74		BEAVER, Mark (Davis' second cousin's husband).
43	 Markie Elisabeth (Davis' second cousin, once removed).
288	15	BECK [FRANKS], Ruby Mable (Davis' great-great-aunt).
194		BLALOCK [DUPREE], Joan Elizabeth (Davis' fourth cousin, once removed).
134		BRADLEY [PLEASANT], Evelyn (Davis' cousin's wife, once removed).
136		BRADLEY [S], Jane (Davis' cousin's wife, once removed).
210	7	BRADLEY [WOODALL], Sallie Muriel (Davis' great-aunt).
132		BRADLEY, Carolyn Muriel (Davis' cousin, once removed).
75	 Clare Melissa (Davis' second cousin).
135	 Jerry Mac (Davis' cousin, once removed).
77	 Leeann M (Davis' second cousin).
76	 Rex (Davis' second cousin).
211	 Rex Kenneth (Davis' great-uncle by marriage).
133	 Rex Kenneth, Jr. (Davis' cousin, once removed).
35		BRADSHAW, Shaun (Davis' cousin, once removed).
656		BRENNAN, Christian "Tanner" (Amber Wilson [Powell]'s son).
657	 Joseph Francis "Joey", Jr. (Amber Wilson [Powell]'s husband).
511	72	BRETT [BAGINHOLDE], Mrs (Davis' fourteen-times-great-grandmother).
426	45	BRETT [BARNSDALE (BARNSDELL)], Ann (Davis' seven-times-great-grandmother).
446		BRETT [BRESSIE], Susannah (Davis' step-eight-times-great-grandmother).
495	69	BRETT [FITTON], Cissely (Davis' twelve-times-great-grandmother).
462	56	BRETT [GOSLING], Elizabeth Susan (Davis' nine-times-great-grandmother).
463		BRETT [LOWE], Elizabeth (Davis' nine-times-great-grandfather's wife).
444	51	BRETT [WATERS], Elizabeth (Davis' eight-times-great-grandmother).
503	72	BRETT [WOODE], Ann (Davis' thirteen-times-great-grandmother).
445		BRETT [WOODWARD], Ann (Davis' eight-times-great-grandfather's previous wife).
461	61	BRETT, Edmund (Davis' nine-times-great-grandfather).
494	72 Edward (Davis' twelve-times-great-grandfather).
438	51 James (Davis' seven-times-great-great-uncle).
425	51 John (Davis' seven-times-great-grandfather).
443	56 John (Davis' eight-times-great-grandfather).
437	51 Mary (Davis' seven-times-great-great-aunt).
436	51 Nathaniel (Davis' seven-times-great-great-uncle).

<u>Ref.</u>	<u>Tree</u>	<u>Name (Relationship)</u>
516	72	BRETT, Nicolas (Davis' fifteen-times-great-grandfather).
502	72 Randolphe (Davis' thirteen-times-great-grandfather).
510	72 Thomas (Davis' fourteen-times-great-grandfather).
456	56 William (Davis' eight-times-great-great-uncle).
455	56 William, Jr. (Davis' eight-times-great-great-uncle).
485	65	BRITT [CHETWYND], Margaret (Davis' eleven-times-great-grandmother).
401		BRITT [CONNOLLY], Winifred (Davis' step-six-times-great-grandmother).
475	61	BRITT [COWARD], Ursula (Davis' ten-times-great-grandmother).
377		BRITT [DAVIS], Olive (Davis' five-times-great-grandfather's wife).
399	39	BRITT [FENNO], Freelove (Davis' six-times-great-grandmother).
264	8	BRITT [GUY], Mary Francis (Davis' great-grandmother).
400		BRITT [MOODY], Mary (Davis' step-six-times-great-grandmother).
333	19	BRITT [PENNY], Charlotte (Davis' great-great-great-grandmother).
357	25	BRITT [STEPHENS], Nancy (Davis' four-times-great-grandmother).
309	8	BRITT [YOUNG], Edith Rebecca (Davis' great-great-grandmother).
376	32	BRITT, Ms. (Davis' five-times-great-grandmother).
215	8 Broughton C (Davis' great-uncle).
391	 Daniel (Davis' five-times-great-great-uncle).
454	56 Elizabeth Brett (Davis' eight-times-great-great-aunt).
413	45 Hannah (Davis' six-times-great-great-aunt).
332	25 Hardy (Davis' great-great-great-grandfather).
213	8 Ila (Davis' great-aunt).
216	8 Ira (Davis' great-uncle).
390	 James (Davis' five-times-great-great-uncle).
389	 John (Davis' five-times-great-great-uncle).
398	45 John, Jr. (Davis' six-times-great-grandfather).
375	39 Joseph (Davis' five-times-great-grandfather).
280	13 Joseph Burke (Davis' great-great-uncle).
308	19 Joseph Leonard (Davis' great-great-grandfather).
356	32 Joseph, Jr. (Davis' four-times-great-grandfather).
263	13 Leonard Lethco (Davis' great-grandfather).
279	13 Luella Etta (Davis' great-great-aunt).
278	13 Martha Charlotte (Davis' great-great-aunt).
281	13 Mary (Davis' great-great-aunt).
392	 Milly (Davis' five-times-great-great-aunt).
393	 Molly (Davis' five-times-great-great-aunt).
484	69 Randle Brett (Davis' eleven-times-great-grandfather).
453	56 Susan Brett (Davis' eight-times-great-great-aunt).
276	13 Susanna Kincaid (Davis' great-great-aunt).
474	65 Thomas Brett (Davis' ten-times-great-grandfather).
275	13 Troy Randolph (Davis' great-great-uncle).
414	45 William Brett (Davis' six-times-great-great-uncle).
277	13 Zeba Bunyan (Davis' great-great-uncle).
671		BUIE, Mr. (Shotzi Butts [Buie]'s husband).
669	 Candie (Shotzi Butts [Buie]'s daughter).
670	 Chrissy (Shotzi Butts [Buie]'s daughter).
56		BUTTS [BUIE], Shotzi (Davis' cousin's wife).
111	5	BUTTS [WOODALL], Doris Britt (Davis' aunt).
112		BUTTS, James Clayborn (Davis' uncle by marriage).
55	 James Lenn (Davis' cousin).
28	 Michelle (Davis' cousin, once removed).
23		CAPPS [KIDWELL], Kristen (Davis' nephew's wife).
27		CAPPS [WOOD], Jessica (Davis' nephew's wife).
53	4	CAPPS [WOODALL], Linda Kay (Davis' sister).
26		CAPPS, Adam Bryant (Davis' nephew).
10	 Addison Bailey (Davis' great-niece).
54	 Joseph Edgar (Davis' brother-in-law).
22	 Joseph Edgar, Jr. (Davis' nephew).

<u>Ref.</u>	<u>Tree</u>	<u>Name (Relationship)</u>
6		CAPPS, Maddox (Davis' great-nephew).
5	 Tovi Piper (Davis' great-niece).
173		CARROLL [FRANKS], Betty "Josephine" (Davis' second cousin, once removed).
101		CARROLL [NOBLING], Jenny (Davis' third cousin's wife).
100		CARROLL, Frankie Wayne "Red Bug" (Davis' third cousin).
49	 Jeremy Wayne (Davis' third cousin, once removed).
174	 William Nathan "Mutt" (Davis' second cousin's husband, once removed).
57		CHAMBERS [BUTTS], Leland Diane (Davis' cousin).
58		CHAMBERS, Johnnie Loteze (Davis' cousin's husband).
29	 Kristy (Davis' cousin, once removed).
491	59	CLOIS CLOWES CLEWLOWE CLULOW, Lady Isabell (Davis' twelve-times-great-grandmother).
490	59 Sir John (Davis' twelve-times-great-grandfather).
225	9	CREECH [DUPREE], Lois (Davis' great-aunt).
157		CREECH, Martha Rebecca (Davis' cousin, once removed).
226	 Wayman (Davis' great-uncle by marriage).
195		DAVIS [DUPREE], Beverly Clay (Davis' fourth cousin, once removed).
659		DAVIS [TALTON], Ila Mae (Bill Ulysses Davis' mother).
113	5	DAVIS [WOODALL], Frances Loraine (Davis' aunt).
114		DAVIS, Bill Ulysses (Davis' uncle by marriage).
60	 Carolyn (Davis' cousin's wife).
33	 Christopher Cullen (Davis' cousin, once removed).
658	 General William "Will" (Bill Ulysses Davis' father).
32	 Rev. Brian (Davis' cousin, once removed).
59	 Robert Britt (Davis' cousin).
61	 Ronald Williard "Buddy" (Davis' cousin).
34	 Will (Davis' cousin, once removed).
576	108	DE MONTGOMERY, I, Hugh (Davis' thirty-times-great-grandfather).
587	110 Roger (Davis' thirty-four-times-great-grandfather).
585	110	DE MONTGOMERY, II, Roger (Davis' thirty-three-times-great-grandfather).
583	110	DE MONTGOMERY, III, Roger (Davis' thirty-two-times-great-grandfather).
125		DEAN [WHELESS], Annie Duke (Davis' cousin's wife, once removed).
202	7	DEAN [WOODALL], Bettie Vandon (Davis' great-aunt).
126		DEAN, Betty Lou (Davis' cousin, once removed).
124	 Edward Woodall (Davis' cousin, once removed).
203	 Fred Edward (Davis' great-uncle by marriage).
103		DOLAN [FRANKS], Lisa M (Davis' third cousin).
534	87	DU PUY I, KNIGHT, LORD OF ROCHEFORT, Gilles (Davis' nineteen-times-great-grandfather).
562	101	DU PUY I, LORD OF ROCHEFORT, Hugues (Davis' twenty-six-times-great-grandfather).
554	97	DU PUY II, SEIGNEUR DE PEREINS, ROCHEFORT, APIFER & MONTBRUN, Chevalier Hugues (Davis' twenty-four-times-great-grandfather).
530	85	DU PUY II, LORD OF PEREINS, Gillies (Davis' eighteen-times-great-grandfather).
550	95	DU PUY II, SEIGNEUR DE PEREINS, Chevalier Alleman de Montbrun (Davis' twenty-three-times-great-grandfather).
546	93	DU PUY III, SGR. OF BORDEAU, Alleman (Davis' twenty-two-times-great-grandfather).
567	101	DU PUY, COUNTESS OF CONTEVILLE [DE BÉRENGS, DE ARCHAIC], Pétronille (Davis' twenty-seven-times-great-grandmother).
477	62	DUPRE [BESSONET], Margeurite (Davis' ten-times-great-grandmother).
527	81	DUPRE [DEVERMONDOIS], Paschale (Davis' seventeen-times-great-grandmother).
522	79	DUPRE [ESTEVEVES], Lady Maria (Davis' sixteen-times-great-grandmother).
513	75	DUPRE [GAILLARD], Anonette (Davis' fourteen-times-great-grandmother).
487	66	DUPRE [GONZALES], Elizabeth (Davis' eleven-times-great-grandmother).
505	73	DUPRE [JOSPIN], Alice (Davis' thirteen-times-great-grandmother).
497	70	DUPRE [MOEZE], Suzanne (Davis' twelve-times-great-grandmother).
518	77	DUPRE [VILLIERS], Agnes (Davis' fifteen-times-great-grandmother).
464	62	DUPRE, Barthelemy (Davis' nine-times-great-grandfather).
512	77 Jaques "James" Henre (Davis' fourteen-times-great-grandfather).
517	79 Jaques Henre, II (Davis' fifteen-times-great-grandfather).
476	66 Jean (Davis' ten-times-great-grandfather).

<u>Ref.</u>	<u>Tree</u>	<u>Name (Relationship)</u>
486	70	DUPREE, Louis (Davis' eleven-times-great-grandfather).
504	75 Louis Claude, I (Davis' thirteen-times-great-grandfather).
496	73 Louis Claude, II (Davis' twelve-times-great-grandfather).
523	81 Richard de Vermondois, II (Davis' sixteen-times-great-great-uncle).
521	81 Sir Josias (Davis' sixteen-times-great-grandfather).
526	83 Sir Richard (Davis' seventeen-times-great-grandfather).
325		DUPREE [ADAMS], Eliza Jane (Davis' cousin's wife, four times removed).
311	14 Julia Ann (Davis' great-great-grandmother).
349		DUPREE [BLALOCK], Grace (Davis' great-great-great-great-aunt by marriage).
252		DUPREE [BRICKHOUSE], Mattie (Davis' second cousin's wife, twice removed).
379	33	DUPREE [CLARK], Elizabeth Bettie (Davis' five-times-great-grandmother).
228		DUPREE [DENNING], Clara Emily (Davis' great-aunt by marriage).
186		DUPREE [DILDAY], Nancy Adeline (Davis' third cousin's wife, once removed).
428	46	DUPREE [ELLERBEE], Larance Lara (Davis' seven-times-great-grandmother).
220		DUPREE [ENNIS], Mallie (Davis' great-aunt by marriage).
199	10	DUPREE [FRANKS], Ruby Larry (Davis' grandmother).
301		DUPREE [GARDNER], Lalah Florence (Davis' second cousin's wife, three times removed).
403	40	DUPREE [GARRIS], Susannah Elizabeth (Davis' six-times-great-grandmother).
143		DUPREE [GLASGOW], Linda Carol (Davis' cousin's wife, once removed).
337	20	DUPREE [GREGORY], Allie Oliver (Davis' great-great-great-grandmother).
147		DUPREE [HARDEE], Etholea (Davis' cousin's wife, once removed).
120		DUPREE [HONEYCUTT], Rachael Jane (Davis' aunt by marriage).
142		DUPREE [JOHNSON], Mamie Lou (Davis' cousin's wife, once removed).
224		DUPREE [JONES], Mildred (Davis' great-aunt by marriage).
448	52	DUPREE [LAMOREAUX], Mynetta "Mary" Denizot (Davis' eight-times-great-grandmother).
327		DUPREE [LOVE], Fannie Telfer (Davis' cousin's wife, four times removed).
145		DUPREE [MURPHY], Shirley (Davis' cousin's wife, once removed).
260		DUPREE [OGBURN], Blanche William (Davis' third cousin's wife, twice removed).
83		DUPREE [PAGE], Melody Jean (Davis' second cousin's wife).
188		DUPREE [PTTTARD], Joanna Catherine (Davis' third cousin's wife, once removed).
144		DUPREE [RADFORD], Betty Carolyn (Davis' cousin's wife, once removed).
465	57	DUPREE [ROBIN], Matilda (Davis' nine-times-great-grandmother).
299		DUPREE [SMITH], Lugenia Elizabeth "Bettie" (Davis' cousin's wife, three times removed).
152	 Mary Lynn (Davis' cousin's wife, once removed).
320		DUPREE [STANCIL], Eugenia "Jane" (Davis' great-great-great-aunt by marriage).
116		DUPREE [STEPHENSON], Billie Jean (Davis' aunt by marriage).
218	 Myrtle Irene (Davis' great-aunt by marriage).
351		DUPREE [TURLINGTON], Elizabeth (Davis' great-great-great-great-aunt by marriage).
303		DUPREE [WELLS], Elizabeth "Lizzie" (Davis' second cousin's wife, three times removed).
138		DUPREE [WILKERSON], Doris Pearl (Davis' cousin's wife, once removed).
119		DUPREE [WILLIFORD], Larue (Davis' aunt by marriage).
81		DUPREE [WOOD], Ellie Leigh "Bunny" (Davis' second cousin's wife).
256		DUPREE [YOUNG], Clyda (Davis' third cousin's wife, twice removed).
359	26 Kizzie (Davis' four-times-great-grandmother).
266	9 Martha Caroline (Davis' great-grandmother).
255		DUPREE, Alvis Holton (Davis' third cousin, twice removed).
95	 Barry Sherman (Davis' second cousin).
326	 Benjamine Franklin (Davis' cousin, four times removed).
223	9 Cary Melvin (Davis' great-uncle).
227	9 Charles Glenn (Davis' great-uncle).
115	6 Charles Larry (Davis' uncle).
265	14 Charlie Benton (Davis' great-grandfather).
158	 Daley Glenn (Davis' cousin, once removed, via adoption).
141	 Donnie Ray (Davis' cousin, once removed).
219	9 Dorsey Benard (Davis' great-uncle).
106	 Elizabeth (Davis' fourth cousin).
257	 Franklin Taylor, Jr. (Davis' third cousin, twice removed).
302	 Franklin Tell (Davis' second cousin, three times removed).

<u>Ref.</u>	<u>Tree</u>	<u>Name (Relationship)</u>
80		DUPREE, Gary Ken (Davis' second cousin).
402	46 Haley (Davis' six-times-great-grandfather).
378	40 Haley, II (Davis' five-times-great-grandfather).
259	 Harry Clay (Davis' third cousin, twice removed).
358	33 Henry (Davis' four-times-great-grandfather).
300	 Henry Quinton (Davis' second cousin, three times removed).
258	 Herman Keck (Davis' third cousin, twice removed).
348	26 James (Davis' great-great-great-uncle).
146	 James "Wilburn" (Davis' cousin, once removed).
310	20 James G (Davis' great-great-grandfather).
118	6 James Lynwood (Davis' uncle).
321	20 John Benton (Davis' great-great-great-uncle).
185	 John Elmond "J.E.", Jr. (Davis' third cousin, once removed).
251	 John Elmond, Sr. (Davis' second cousin, twice removed).
117	6 John Royster (Davis' uncle).
198	9 John Stuart (Davis' grandfather).
191	 Johnny Lee (Davis' fourth cousin, once removed).
324	 Joseph (Davis' cousin, four times removed).
447	57 Josias "Joseph" Crancie (Davis' eight-times-great-grandfather).
86	 Kari (Davis' second cousin's wife).
85	 Kevin Ray (Davis' second cousin).
62	 Larry Gene (Davis' cousin).
82	 Larry Glenn (Davis' second cousin).
427	52 Loys "Louis" (Davis' seven-times-great-grandfather).
350	26 Nathaniel (Davis' great-great-great-uncle).
217	9 Ottis Alden (Davis' great-uncle).
190	 Ronald Holton (Davis' fourth cousin, once removed).
254	 Ruth Naola (Davis' second cousin's wife, twice removed).
137	 Stacy Lee (Davis' cousin, once removed).
121	6 Stuart Randall "Randy" (Davis' uncle).
336	26 Thomas Jefferson (Davis' great-great-great-grandfather).
151	 Thomas Layton (Davis' cousin, once removed).
298	 William "Anguish" (Davis' cousin, three times removed).
108	 William A, III (Davis' fourth cousin).
187	 William Anguish "W.A.", Jr. (Davis' third cousin, once removed).
253	 William Anguish, Sr. (Davis' second cousin, twice removed).
319	20 William H (Davis' great-great-great-uncle).
633		DURHAM, Caroline F (Karen Denise Woodall [Moore]'s great-grandmother).
632	 Issac R (Karen Denise Woodall [Moore]'s great-grandfather).
63		EASON [DUPREE], Rebecca Sue "Becky" (Davis' cousin).
370	16	ELLIS, Berry (Davis' four-times-great-grandfather).
650		EMERY, Edmund (Karen Denise Woodall [Moore]'s five-times-great-grandfather).
649	 Elizabeth (Karen Denise Woodall [Moore]'s four-times-great-grandmother).
646	 Ephraim (Karen Denise Woodall [Moore]'s great-great-great-grandfather).
648	 Lewis (Karen Denise Woodall [Moore]'s four-times-great-grandfather).
647	 Margaret (Karen Denise Woodall [Moore]'s great-great-great-grandmother).
641		EMORY, Laura (Karen Denise Woodall [Moore]'s great-great-grandmother).
640	 William (Karen Denise Woodall [Moore]'s great-great-grandfather).
214	8	ENNIS [BRITT], Rado Utah (Davis' great-aunt).
94		FEREBEE [DUPREE], Tammy Richelle (Davis' second cousin).
552	96	FITZWARIN III, MARCHER LORD OF WHITTINGTON AND ALVESTON, Sir Fulk (Davis' twenty-four-times-great-grandfather).
553	94	FITZWARIN [DE BLANCMINISTER WARRINE], Eva (Davis' twenty-four-times-great-grandmother).
557	96	FITZWARIN [DE DINAN], Hawise (Davis' twenty-five-times-great-grandmother).
561	98	FITZWARIN [DE WHITTINGTON], Miletta de Whittington (Davis' twenty-six-times-great-grandmother).
560	100	FITZWARIN I, LORD OF WHITTINGTON AND ALDERBURY, "GUARINE DE MEER", "FULKO", Fulk (Davis' twenty-six-times-great-grandfather).
556	98	FITZWARIN II, LORD OF WHITTINGTON AND ALVESTON, Fulk II "Brunin" (Davis' twenty-five-times-great-grandfather).

<u>Ref.</u>	<u>Tree</u>	<u>Name (Relationship)</u>
655		FOWLER, Steve H (Sharon Moore [Mitchell]'s husband).
609		FRANDESCANGELI, Barry R (Karen Denise Woodall [Moore]'s cousin's husband).
593	 Taylor (Karen Denise Woodall [Moore]'s cousin, once removed).
450	53	FRANCK [TIMMERMAN], Sevil Civil (Davis' eight-times-great-grandmother).
449	58	FRANCK, John Martin (Davis' eight-times-great-grandfather).
479	63	FRANCKE [GLOXIN], Anna (Davis' ten-times-great-grandmother).
499	67	FRANCKE [LEIMBACH], Catherina (Davis' twelve-times-great-grandmother).
467	58	FRANCKE [VON WURMB], Anna Magdalena (Davis' nine-times-great-grandmother).
489	67	FRANCKE, Ms. (Davis' eleven-times-great-grandmother).
466	63 August Hermann (Davis' nine-times-great-grandfather).
507	67 Eva (Davis' thirteen-times-great-grandmother).
506	67 Hans (Davis' thirteen-times-great-grandfather).
488	67 Hans Francke (Davis' eleven-times-great-grandfather).
498	67 Hermann (Davis' twelve-times-great-grandfather).
478	67 Johannes (Davis' ten-times-great-grandfather).
430	47	FRANKS [ASHLEY], Mary Ann (Davis' seven-times-great-grandmother).
242		FRANKS [BARBOUR], Bettie Allene (Davis' cousin's wife, twice removed).
405	41	FRANKS [COOK], Martha (Davis' six-times-great-grandmother).
381	34	FRANKS [FREEMAN], Sarah (Davis' five-times-great-grandmother).
285		FRANKS [GODWIN], Lillian "Lillie" Mary (Davis' great-great-aunt by marriage).
177		FRANKS [HARDY], Gayle (Davis' second cousin's wife, once removed).
244		FRANKS [HUMPHRIES], Kathleen (Davis' cousin's wife, twice removed).
363	27	FRANKS [HUNTER], Anna (Davis' four-times-great-grandmother).
341	28	FRANKS [JONES], Emma Gasten (Davis' great-great-great-grandmother).
268	16	FRANKS [MARSHBURN], Vienna Jannetta (Davis' great-grandmother).
290		FRANKS [MASSEY], Lydia (Davis' great-great-aunt by marriage).
314		FRANKS [MITCHELL], Martha (Davis' great-great-grandfather's wife).
313	15	FRANKS [PERRY], Lorenda Arinda "Lora" (Davis' great-great-grandmother).
283		FRANKS [SPEARS], Bettie Perry (Davis' great-great-aunt by marriage).
178		FRANKS [SWIGER], Janet Lynne (Davis' second cousin's wife, once removed).
175		FRANKS, "Donald" Ray (Davis' second cousin, once removed).
241	 "Graham" Hubbard (Davis' cousin, twice removed).
295	15 Alpha Byon (Davis' great-great-uncle).
404	47 Anthony (Davis' six-times-great-grandfather).
362	34 Anthony (Davis' four-times-great-grandfather).
294	15 Christopher Clinton (Davis' great-great-uncle).
287	15 Grover Carr (Davis' great-great-uncle).
429	53 Jacob Miller (Davis' seven-times-great-grandfather).
340	27 James "Jim" David (Davis' great-great-great-grandfather).
291	15 James Leslie (Davis' great-great-uncle).
293	15 Lance H. (Davis' great-great-uncle).
284	15 Leddie Bain (Davis' great-great-uncle).
292	15 Lee Perry (Davis' great-great-uncle).
380	41 Lewis Henry (Davis' five-times-great-grandfather).
289	15 Lewis Nathaniel "Snooks" (Davis' great-great-uncle).
243	 Luther Warren (Davis' cousin, twice removed).
323	21 Mary Elizabeth (Davis' great-great-great-aunt).
176	 Michael (Davis' second cousin, once removed).
322	21 Mosley R H (Davis' great-great-great-uncle).
267	15 Robert Larry (Davis' great-grandfather).
282	15 Samuel "Lattie" (Davis' great-great-uncle).
104	 Scott P (Davis' third cousin).
312	21 William Nathaniel "Nat" (Davis' great-great-grandfather).
139		FUQUAY [DUPREE], Shirley Ann (Davis' cousin, once removed).
140		FUQUAY, Cecil Adair (Davis' cousin's partner, once removed).
84	 Lisa Ann (Davis' second cousin).
189		GASKIN [DUPREE], Donna Kay (Davis' fourth cousin, once removed).
607		GOFFREDO [PUMROY], Angela (Karen Denise Woodall [Moore]'s cousin).

<u>Ref.</u>	<u>Tree</u>	<u>Name (Relationship)</u>
608		GOFFREDO, Victor D (Karen Denise Woodall [Moore]'s cousin's husband).
286	15	HAYES [FRANKS], Emma Foy (Davis' great-great-aunt).
105		HILL [DUPREE], Deborah Lynn (Davis' fourth cousin).
65		HONEYCUTT [DUPREE], Laura Lynn (Davis' cousin).
39		HONEYCUTT [OVERBY], Hannah Elizabeth (Davis' cousin's wife, once removed).
40		HONEYCUTT, Ally Elizabeth (Davis' cousin, once removed).
38	 Cade Wallace (Davis' cousin, once removed).
66	 Michael Wallace (Davis' cousin's husband).
12	 Palmer Grace (Davis' cousin, twice removed).
71		JACKSON [BRADLEY], Robin (Davis' second cousin).
42		JACKSON, Bradley Ray (Davis' second cousin, once removed).
41	 John Keith, II (Davis' second cousin, once removed).
72	 Keith (Davis' second cousin's husband).
672		JARVIS [ROSE], Asley Swiger (Janet Lynne Franks [Swiger]'s daughter).
653		JOHNSON [FOWLER], Nicole (Sharon Moore [Mitchell]'s daughter).
652		JOHNSON, Cassidy Nicole (Sharon Moore [Mitchell]'s granddaughter).
651	 Cooper Steven (Sharon Moore [Mitchell]'s grandson).
654	 Michael (Sharon Moore [Mitchell]'s son-in-law).
365	35	JONES [LANE], Martha Ann (Davis' four-times-great-grandmother).
237		JONES [WATKINS], Ida (Davis' great-aunt).
364	21	JONES, Austin (Davis' four-times-great-grandfather).
238	 Gordon (Davis' great-uncle by marriage).
383	21 Peggy (Davis' five-times-great-grandmother).
382	21 Robert (Davis' five-times-great-grandfather).
172	 Susan (Davis' cousin, once removed).
544	92	LAGA, DE, Reginald "Reginald Reynor de la Lea" (Davis' twenty-two-times-great-grandfather).
545	90 Rei Lega (Davis' twenty-two-times-great-grandmother).
385	35	LANE [SMITH], Elizabeth (Davis' five-times-great-grandmother).
407	42	LANE [SPEIGHT], Lydia (Davis' six-times-great-grandmother).
406	42	LANE, James (Davis' six-times-great-grandfather).
384	42 Nathaniel M. (Davis' five-times-great-grandfather).
156		LEE [ADAMS], Jean Caroline (Davis' cousin, once removed).
374	31	LEE [ALLEN], Mary (Davis' five-times-great-grandmother).
529	82	LEE [ASTLEY], DE, Margaret "Margaret de Astley" (Davis' eighteen-times-great-grandmother).
483	64	LEE [BENDEY], Elizabeth (Davis' eleven-times-great-grandmother).
501	71	LEE [BLOUNT], Katherine (Davis' thirteen-times-great-grandmother).
397	38	LEE [BRYAN], Mary (Davis' six-times-great-grandmother).
331	18	LEE [COATS], Sally (Davis' great-great-great-grandmother).
460	55	LEE [CONSTABLE], Ann (Davis' nine-times-great-grandmother).
537	86	LEE [CORBET], DE LA, Petronilla (Davis' twenty-times-great-grandmother).
442	50	LEE [FELTON], Alice (Davis' eight-times-great-grandmother).
473	60	LEE [HANCOCK], Jane (Davis' ten-times-great-grandmother).
509	74	LEE [MORTON], Johanna (Davis' fourteen-times-great-grandmother).
525	80	LEE [PIMHALL], Petronella "Petronilla Of Lampley /De Lee/", " (Davis' seventeen-times-great-grandmother).
355	24	LEE [RAINS], Ann (Davis' four-times-great-grandmother).
520	78	LEE [RIDLEY], Isabella (Davis' sixteen-times-great-grandmother).
493	68	LEE [ROMNEY], Joyce (Davis' twelve-times-great-grandmother).
307	12	LEE [ROSE], Lucy E (Davis' great-great-grandmother).
515	76	LEE [SPRENCHEAUX], Margery Sprencheaux (Davis' fifteen-times-great-grandmother).
424	44	LEE [YOUNG], Mary (Davis' seven-times-great-grandmother).
532	86	LEE, DE LA, John, II (Davis' nineteen-times-great-grandfather).
533	84 Margaret (Davis' nineteen-times-great-grandmother).
541	88 Rei Mnu (Davis' twenty-one-times-great-grandmother).
540	90 Sir John "John Lee Esquire" (Davis' twenty-one-times-great-grandfather).
536	88 Sir Thomas (Davis' twenty-times-great-grandfather).
528	84	LEE, DE, Roger "Robert" (Davis' eighteen-times-great-grandfather).
396	44	LEE, Capt. John Esquire (Davis' six-times-great-grandfather).
459	60 Colonel Richard Henry (Davis' nine-times-great-grandfather).

<u>Ref.</u>	<u>Tree</u>	<u>Name (Relationship)</u>
373	38	LEE, Edward G (Davis' five-times-great-grandfather).
330	24 Henry "Harry" (Davis' great-great-great-grandfather).
468	60 John, II (Davis' nine-times-great-great-uncle).
472	64 John, Sr. (Davis' ten-times-great-grandfather).
354	31 Lemuel Samuel "Lom" (Davis' four-times-great-grandfather).
519	80 Radolphus "Ralph de Lee" (Davis' sixteen-times-great-grandfather).
306	18 Ransom (Davis' great-great-grandfather).
482	68 Richard (Davis' eleven-times-great-grandfather).
423	50 Richard Henry (Davis' seven-times-great-grandfather).
524	82 Robert "Robert /De Lee/", " (Davis' seventeen-times-great-grandfather).
500	74 Sir Humphrey "Humphrey De Lee" (Davis' thirteen-times-great-grandfather).
492	71 Sir John "John Lee Esquire" (Davis' twelve-times-great-grandfather).
514	78 Sir Richard "Recardus /De Lee/ Lee", Lee" (Davis' fifteen-times-great-grandfather).
508	76 Sir Thomas (Davis' fourteen-times-great-grandfather).
469	60 Thomas (Davis' nine-times-great-great-uncle).
441	55 William (Davis' eight-times-great-grandfather).
549	92	LEGA, DE, Christian De Stainton (Davis' twenty-three-times-great-grandmother).
548	94 Hugo "Hugo de La Lea /de Lee/", " (Davis' twenty-three-times-great-grandfather).
629		LOCKERMAN, Mr. (Karen Denise Woodall [Moore]'s grandmother's husband).
624	 Johnny (Karen Denise Woodall [Moore]'s uncle).
674		LOWE, John, Jr. (Elizabeth Brett [Lowe]'s father).
96		MARLER [DUPREE], Heather Dawn (Davis' second cousin).
347	16	MARSHBURN [ELLIS], Susan (Davis' great-great-great-grandmother).
316	16	MARSHBURN [PARKER], Susan Alice (Davis' great-great-grandmother).
315	22	MARSHBURN, Dr Berry Daniel (Davis' great-great-grandfather).
346	29 William (Davis' great-great-great-grandfather).
410		MASHBURN [NASH], Elizabeth (Davis' six-times-great-grandfather's wife).
409	29	MASHBURN [RHODES], Elizabeth (Davis' six-times-great-grandmother).
434	48	MASHBURN [SINDERY], Sarah (Davis' seven-times-great-grandmother).
435		MASHBURN [STEPHENS], Allie (Davis' seven-times-great-grandfather's wife).
369	22	MASHBURN [WARREN], Delphia (Davis' four-times-great-grandmother).
408	48	MASHBURN, Edward Mashborne, Jr. (Davis' six-times-great-grandfather).
433	48 Edward Mashborne, Sr. (Davis' seven-times-great-grandfather).
417	 Etta (Davis' six-times-great-great-aunt).
415	 Kit Carson (Davis' six-times-great-great-uncle).
386	29 Matthew (Davis' five-times-great-grandfather).
420	48 Matthew (Davis' six-times-great-great-uncle).
368	36 Pvt Daniel (Davis' four-times-great-grandfather).
416	 Ruby (Davis' six-times-great-great-aunt).
418	48 Samuel (Davis' six-times-great-great-uncle).
387	36 Sarah (Davis' five-times-great-grandmother).
419	48 Sarah (Davis' six-times-great-great-aunt).
645		MATHIS [PETTERSON], Julia (Karen Denise Woodall [Moore]'s great-great-grandmother).
644		MATHIS, Wells (Karen Denise Woodall [Moore]'s great-great-grandfather).
88		MAYE, Roger Wayne (Davis' second cousin's husband).
594		MELLOR, Rachel Tiffany (Karen Denise Woodall [Moore]'s cousin, once removed).
610	 Richard A (Karen Denise Woodall [Moore]'s cousin's husband).
569	104	METZ [DE MONTGOMERY], DE, Aimeria Emma de Montgomery (Davis' twenty-eight-times-great-grandmother).
565	100	METZ [PEVERELL], DE, Baroness Melette Maud ,Heiress of Whittington, "Maud de Ingelrica" (Davis' twenty-seven-times-great-grandmother).
564	102	METZ, DE, Sir Guy Warin "the Bold" (Davis' twenty-seven-times-great-grandfather).
568	102 Warine "The Sherriff" (Davis' twenty-eight-times-great-grandfather).
577	106	MONTGOMERY [DE NORMANDIE], DE, Joscelina (Davis' thirty-times-great-grandmother).
581	108	MONTGOMERY [DE TRIPON], DE, Elizabeth (Davis' thirty-one-times-great-grandmother).
573	104	MONTGOMERY [DE VETULIS], DE, Joseline (Davis' twenty-nine-times-great-grandmother).
572	106	MONTGOMERY, DE, Gilbert (Davis' twenty-nine-times-great-grandfather).
580	110 William (Davis' thirty-one-times-great-grandfather).
600		MOORE [CRATCH], Deborah Joanne (Karen Denise Woodall [Moore]'s sister-in-law).

<u>Ref.</u>	<u>Tree</u>	<u>Name (Relationship)</u>
626		MOORE [DURHAM], Mamie Ethel (Karen Denise Woodall [Moore]'s grandmother).
617		MOORE [GRAY], Lora Ann (Karen Denise Woodall [Moore]'s father's wife).
591		MOORE [MILLSAPS], Heather (Karen Denise Woodall [Moore]'s nephew's wife).
601		MOORE [MITCHELL], Sharon (Karen Denise Woodall [Moore]'s sister-in-law).
619		MOORE [WASHINGTON], Nancy Carol (Karen Denise Woodall [Moore]'s aunt by marriage).
616		MOORE [WILSON], Betty Jean "BJ" (Karen Denise Woodall [Moore]'s mother).
589		MOORE, Brody Matthew (Karen Denise Woodall [Moore]'s nephew).
618	 Charles Allen (Karen Denise Woodall [Moore]'s uncle).
588	 Easton Neal (Karen Denise Woodall [Moore]'s great-nephew).
598	 Kristen (Karen Denise Woodall [Moore]'s sister-in-law).
639	 Mary (Karen Denise Woodall [Moore]'s great-great-grandmother).
602	 Michael Allen (Karen Denise Woodall [Moore]'s cousin).
630	 Neal Henry (Karen Denise Woodall [Moore]'s great-grandfather).
625	 Roy Neal (Karen Denise Woodall [Moore]'s grandfather).
599	 Roy Neal, III (Karen Denise Woodall [Moore]'s brother).
615	 Roy Neal, Jr. (Karen Denise Woodall [Moore]'s father).
590	 Ryan Neal (Karen Denise Woodall [Moore]'s nephew).
592	 Shannen Jean (Karen Denise Woodall [Moore]'s niece).
631	 Sophony Emery (Karen Denise Woodall [Moore]'s great-grandmother).
597	 Steven Neal (Karen Denise Woodall [Moore]'s half-brother).
638	 William (Karen Denise Woodall [Moore]'s great-great-grandfather).
603	 William Martin "Marty" (Karen Denise Woodall [Moore]'s cousin).
149		O'NEAL [DUPREE], Patsy Ennis (Davis' cousin, once removed).
148	 Susan Evelyn (Davis' cousin, once removed).
91		O'NEAL, Dennis Alan (Davis' second cousin).
150	 Herman Dennis (Davis' cousin's husband, once removed).
93	 Mark Andrew (Davis' second cousin).
92	 Terry Lee (Davis' second cousin).
30		PANKOP [CHAMBERS], Sarah (Davis' cousin, once removed).
31		PANKOP, Ashley (Davis' cousin's husband, once removed).
11	 Audrey (Davis' cousin, twice removed).
367	15	PERRY [BAKER], Nancy Ann (Davis' four-times-great-grandmother).
344		PERRY [HORTON], Mitty Ann (Davis' step-great-great-great-grandmother).
343	15	PERRY [SPEIGHT], Julia A. (Davis' great-great-great-grandmother).
345		PERRY [WATKINS], Jane Ellen (Davis' great-great-great-grandfather's wife).
366	15	PERRY, John W (Davis' four-times-great-grandfather).
342	15 Robert Sidney (Davis' great-great-great-grandfather).
107		PETREA [DUPREE], Ruth (Davis' fourth cousin).
571	103	PODIO [DE HEITZ], DE, Amelie (Davis' twenty-eight-times-great-grandmother).
579	107	PODIO DEL PUECH [D'ARCHINGAUX], DE, Jeanne (Davis' thirty-times-great-grandmother).
575	105	PODIO DEL PUECH [D'OPFIKON], DE, Berchta (Davis' twenty-nine-times-great-grandmother).
584	109	PODIO DEL PUECH, DE, Adminius Amminius (Davis' thirty-two-times-great-grandfather).
578	109 Amelius Simplius (de Pugio) (Davis' thirty-times-great-grandfather).
574	107 Guillaume (Davis' twenty-nine-times-great-grandfather).
582	109 Norman Anglo saxony (de Pugio) (Davis' thirty-one-times-great-grandfather).
570	105	PODIO, DE, Raymond Guillaume (Davis' twenty-eight-times-great-grandfather).
163		POOLE [WATKINS], Bonnie Lou (Davis' cousin, once removed).
99		POOLE, Matthew Shane (Davis' second cousin).
164	 Ronnie Lynn (Davis' cousin's husband, once removed).
87		PRICE [DUPREE], Susan "Elaine" (Davis' second cousin).
44		PRICE, Brandon Lee (Davis' second cousin, once removed).
89	 Mark Lee (Davis' second cousin's husband).
412	43	PRIOR [WOODALL], Sarah (Davis' six-times-great-great-aunt).
586	109	PUGIO, DE, Gaius Suetonius Paulinus (Davis' thirty-three-times-great-grandfather).
620		PUMROY [WILSON], Edna (Karen Denise Woodall [Moore]'s aunt).
621		PUMROY, Charles R "Chuck" (Karen Denise Woodall [Moore]'s uncle by marriage).
606	 Gregory Wayne (Karen Denise Woodall [Moore]'s cousin).
547	91	PUY [ARTOD], DU, Beatrix Tournon (Davis' twenty-two-times-great-grandmother).

<u>Ref.</u>	<u>Tree</u>	<u>Name (Relationship)</u>
535	85	PUY [DE BELLECOMBE], DU, Alix (Davis' nineteen-times-great-grandmother).
531	83	PUY [DE HAUTEVILLE], DU, Lady Marie Florence (Davis' eighteen-times-great-grandmother).
543	89	PUY [DE LANCOIL], DU, Eleanore Alleman (Davis' twenty-one-times-great-grandmother).
555	95	PUY [DE MORIAN], DU, Floride (Davis' twenty-four-times-great-grandmother).
539	87	PUY [DE ROLAND], DU, Ainarde (Davis' twenty-times-great-grandmother).
558	99	PUY I, DU, Chevalier Alleman (Davis' twenty-five-times-great-grandfather).
542	91	PUY IV, DU, Chevalier Alleman (Davis' twenty-one-times-great-grandfather).
538	89	PUY V, DU, Lord Alleman (Davis' twenty-times-great-grandfather).
551	93	PUY, DU, Alix Princess of Dauphine (Davis' twenty-three-times-great-grandmother).
563	99 Deurard DE POISIEU (Davis' twenty-six-times-great-grandmother).
566	103 Grand Chamberlain Conrad II Raphael (del Poggio) (Davis' twenty-seven-times-great-grandfather).
559	97 Lady Veronique Ademar (Davis' twenty-five-times-great-grandmother).
636		QUINN, John Henry (Karen Denise Woodall [Moore]'s great-grandfather).
637	 Rachel Stroud (Karen Denise Woodall [Moore]'s great-grandmother).
604		ROGERS [PUMROY], Sharon (Karen Denise Woodall [Moore]'s cousin).
605		ROGERS, Bob (Karen Denise Woodall [Moore]'s cousin's husband).
673		ROSE, Jonathan Lemoyne (Janet Lynne Franks [Swiger]'s husband).
78		ROWE [DUPREE], Kathy Lynn (Davis' second cousin).
79		ROWE, Larry David (Davis' second cousin's husband).
212	8	SEXTON [BRITT], Annie (Davis' great-aunt).
663		SHEETS, Mr. (Billie Jean Dupree [Stephenson]'s partner).
660	 Angelique (Billie Jean Dupree [Stephenson]'s granddaughter).
662	 Jerri (Billie Jean Dupree [Stephenson]'s son's partner).
661	 Robert Lynn "Bobby" (Billie Jean Dupree [Stephenson]'s son).
245		SHEPARD [FRANKS], Annie Lee (Davis' cousin, twice removed).
246		SHEPARD, Graham Dennis (Davis' cousin's husband, twice removed).
24		SMITH [CAPPS], Jennifer Lynn (Davis' niece).
9		SMITH, Caitlin (Davis' great-niece).
8	 Caleb (Davis' great-nephew).
7	 Camden (Davis' great-nephew).
25	 Harry Lee, Jr. (Davis' niece's husband).
452	42	SPAIGHT [POWELL], Elizabeth (Davis' eight-times-great-grandmother).
432	42	SPAIGHT [WESTROPP], Abigail (Davis' seven-times-great-grandmother).
431	42	SPAIGHT, Captain William (Davis' seven-times-great-grandfather).
451	42	SPEIGHT, John Thomas (Davis' eight-times-great-grandfather).
47		STEPHENSON [YOUNG], Allison Leslie (Davis' second cousin, once removed).
16		STEPHENSON, Addison (Davis' second cousin, twice removed).
15	 Reagan (Davis' second cousin, twice removed).
48	 Tracy Alan (Davis' second cousin's husband, once removed).
45		THOMAS [YOUNG], Susan "Kelly" (Davis' second cousin, once removed).
46		THOMAS, Chad David (Davis' second cousin's husband, once removed).
13	 Kendall (Davis' second cousin, twice removed).
14	 Taylor (Davis' second cousin, twice removed).
37		THOMPSON, Bliss (Davis' cousin, once removed).
64	 Tommy (Davis' cousin's husband).
36	 Tommy (Davis' cousin, once removed).
165		THOMPSON [WATKINS], Susan Matthew (Davis' cousin, once removed).
166		THOMPSON, Garland (Davis' cousin's husband, once removed).
388	22	WARREN, George (Davis' five-times-great-grandfather).
234		WATKINS [DAVIS], Barbara Jean (Davis' great-aunt by marriage).
233		WATKINS [JOHNSON], Carolyn (Davis' great-aunt by marriage).
230		WATKINS [MATTHEWS], Virginia Grace (Davis' great-aunt by marriage).
236		WATKINS [TAYLOR], Eira (Davis' great-aunt by marriage).
160	 Sherry Lynne (Davis' cousin's wife, once removed).
231		WATKINS [WILKERSON], Shirley Faye (Davis' great-aunt by marriage).
229		WATKINS, CPL Kenneth Lee (Davis' great-uncle).
232	 Daniel Parker "Danny" (Davis' great-uncle).
167	 Daniel Parker "Danny", Jr. (Davis' cousin, once removed).

<u>Ref.</u>	<u>Tree</u>	<u>Name (Relationship)</u>
169		WATKINS, David (Davis' cousin, once removed).
159	 Johnny Lee (Davis' cousin, once removed).
98	 Kenneth Marvin (Davis' second cousin).
171	 Timothy Marshburn "Timmy" (Davis' cousin, once removed).
269	 William Adderson (Davis' great-grandmother's husband).
235	 William Marshburn "Bill" (Davis' great-uncle).
170	 William Taylor "Billy" (Davis' cousin, once removed).
193		WHITE [DUPREE], Janet Lynn (Davis' fourth cousin, once removed).
623		WILSON [BROWN], Joan (Karen Denise Woodall [Moore]'s aunt by marriage).
643		WILSON [FASON], Fannie (Karen Denise Woodall [Moore]'s great-great-grandmother).
612		WILSON [HAWES], Frances (Karen Denise Woodall [Moore]'s cousin's wife).
614		WILSON [POWELL], Amber (Karen Denise Woodall [Moore]'s cousin's wife).
628		WILSON [QUINN], Effie Ray (Karen Denise Woodall [Moore]'s grandmother).
634		WILSON, Cecil Ripton (Karen Denise Woodall [Moore]'s great-grandfather).
613	 Patrick "Brian" (Karen Denise Woodall [Moore]'s cousin).
635	 Rebecca Mathis (Karen Denise Woodall [Moore]'s great-grandmother).
596	 Ripley (Karen Denise Woodall [Moore]'s cousin, once removed).
611	 William Edward "Billy", Jr. (Karen Denise Woodall [Moore]'s cousin).
622	 William Edward "Billy", Sr. (Karen Denise Woodall [Moore]'s uncle).
595	 William Edward "Will", III (Karen Denise Woodall [Moore]'s cousin, once removed).
627	 William Wells (Karen Denise Woodall [Moore]'s grandfather).
642	 William Wright (Karen Denise Woodall [Moore]'s great-great-grandfather).
250		WOODALL [ALLEY], Leah Elizabeth (Davis' second cousin's wife, twice removed).
329	17	WOODALL [BARBER], Sarah "Sally" (Davis' great-great-great-grandmother).
197	8	WOODALL [BRITT], Alda Leland (Davis' grandmother).
297		WOODALL [CREECH], Mattie (Davis' cousin's wife, three times removed).
110	6	WOODALL [DUPREE], Betty Sue (Davis' mother).
318		WOODALL [ELDRIDGE], Emily (Davis' great-great-great-aunt by marriage).
208		WOODALL [FISH], Candice Mozelle (Davis' great-aunt by marriage).
201		WOODALL [GOLDSTON], Fannie Lee (Davis' great-aunt by marriage).
353	23	WOODALL [GOWER], Lucy Phereby (Davis' four-times-great-grandmother).
440	49	WOODALL [HENCHPOLE], Sarah (Davis' eight-times-great-grandmother).
372	30	WOODALL [HICKS], Agnes (Davis' five-times-great-grandmother).
206		WOODALL [HOCUTT], Madeline Clyde (Davis' great-aunt by marriage).
481	59	WOODALL [INU/LIGHT], Agnes, Light] (Davis' eleven-times-great-grandmother).
471	59	WOODALL [ITHELL], Mary (Davis' ten-times-great-grandmother).
262	12	WOODALL [LEE], Sarah (Davis' great-grandmother).
52	3	WOODALL [MOORE], Karen Denise (Davis' wife).
18	1	WOODALL [MORGAN], Jesse Marie (Davis' daughter-in-law).
182		WOODALL [OLIVE], Mary (Davis' third cousin's wife, once removed).
395	37	WOODALL [SAMPSON], Judith (Davis' six-times-great-grandmother).
422	43	WOODALL [STANLEY], Sarah (Davis' seven-times-great-grandmother).
458	54	WOODALL [STAUELIE], Sara (Davis' nine-times-great-grandmother).
131		WOODALL [WEAVER], Shelby (Davis' cousin's wife, once removed).
305	11	WOODALL [WELLONS], Eliza (Davis' great-great-grandmother).
20	2	WOODALL [WILDER], Christine Denise (Davis' daughter-in-law).
127		WOODALL II, Edward Hale (Davis' cousin, once removed).
122		WOODALL JR., Hunter McGuire (Davis' cousin, once removed).
207	7	WOODALL, Bert Albert (Davis' great-uncle).
17	3 Bryant Lee (Davis' son).
304	17 Burt A (Davis' great-great-grandfather).
4	2 Carter Davis (Davis' grandson).
21	3 Chase Hunter (Davis' son).
67	 Christopher Lee (Davis' second cousin).
204	7 Clida Lee (Davis' great-aunt).
19	3 Cody Davis (Davis' son).
271	 Cornelia (Davis' great-great-aunt by marriage).
274	11 David O. (Davis' great-great-uncle).

<u>Ref.</u>	<u>Tree</u>	<u>Name (Relationship)</u>
109	5	WOODALL, Davis Bryant (Davis' father).
51	4 Davis Bryant "Dave", Jr. (The subject of this report).
249	 Dewitt Creech (Davis' second cousin, twice removed).
181	 Dewitt Creech "Woody", Jr. (Davis' third cousin, once removed).
439	54 Dr. John William (Davis' eight-times-great-grandfather).
261	11 Edward Hale (Davis' great-grandfather).
129	 Edward Marshall (Davis' cousin, once removed).
180	 Elizabeth Ellen "Beth" (Davis' third cousin, once removed).
273	11 Emma (Davis' great-great-aunt).
183	 Frank Alley "Al" (Davis' third cousin, once removed).
196	7 Gilbert Chesley (Davis' grandfather).
130	 Harold Bert (Davis' cousin, once removed).
240	 Hubert C (Davis' cousin, twice removed).
200	7 Hunter McGuire (Davis' great-uncle).
184	 Jackie (Davis' third cousin's wife, once removed).
371	37 Jacob (Davis' five-times-great-grandfather).
352	30 Jacob B. (Davis' four-times-great-grandfather).
328	23 James Gower (Davis' great-great-great-grandfather).
421	49 John (Davis' seven-times-great-grandfather).
296	 John Franklin (Davis' cousin, three times removed).
317	17 John G (Davis' great-great-great-uncle).
394	43 John Issac (Davis' six-times-great-grandfather).
239	 Kate (Davis' cousin, twice removed).
272	11 Katie (Davis' great-great-aunt).
70	 Kimberly (Davis' second cousin's wife).
480	59 Laurence (Davis' eleven-times-great-grandfather).
205	7 Leigh Edward (Davis' great-uncle).
128	 Martha Stella (Davis' cousin, once removed).
69	 Michael Scott (Davis' second cousin).
3	2 Peyton James (Davis' grandson).
470	59 Richard (Davis' ten-times-great-grandfather).
123	 Sarah Francis (Davis' cousin, once removed).
457	59 Surgeon General John (Davis' nine-times-great-grandfather).
68	 Tamara (Davis' second cousin's wife).
1	1 Walker Samuel (Davis' grandson).
411	43 William, Sr. (Davis' six-times-great-great-uncle).
270	11 Willis L. (Davis' great-great-uncle).
209	7 Willis Lester (Davis' great-uncle).
2	1 Wyatt Lee (Davis' grandson).
335	8	YOUNG [TOMLINSON], Patsy (Davis' great-great-great-grandmother).
90		YOUNG, Bobby Willis (Davis' second cousin's husband).
334	8 Young Ezekiel, Sr. (Davis' great-great-great-grandfather).